

# ***MX34***

# ***Online Manual***

DOC. NO. : MX34-OL-E0003A

## What's in this manual

<b>MX34 .....</b>	<b>1</b>
<i>What's in this manual</i> .....	2
<i>Before You Start</i> .....	9
<i>Quick Installation Procedure</i> .....	10
<i>Motherboard Map</i> .....	11
<i>Block Diagram</i> .....	12
<b>Hardware.....</b>	<b>13</b>
<i>JP14 Clear CMOS</i> .....	14
<i>CPU Slot</i> .....	15
<i>CPU and Housing Fan Connector</i> .....	16
<i>CPU Jumper-less Design</i> .....	17
<i>JP29/JP23 FSB/PCI Clock Ratio</i> .....	21
<i>JP33/JP32 Select CPU Type</i> .....	23
<i>DIMM Socket</i> .....	24
<i>RAM Power LED</i> .....	26

<i>Front Panel Connector</i> .....	27
<i>ATX Power Connector</i> .....	29
<i>AC Power Auto Recovery</i> .....	30
<i>IDE and Floppy Connector</i> .....	31
<i>IrDA Connector</i> .....	34
<i>WOM (Zero Voltage Wake on Modem)</i> .....	35
<i>WOL (Wake on LAN)</i> .....	38
<i>4X AGP (Accelerated Graphic Port)</i> .....	40
<i>PC99 Color Coded Back Panel</i> .....	41
<i>Support 4 USB Ports</i> .....	42
<i>JP12 Enable/Disable Onboard Sound</i> .....	43
<i>JP27 Enable/Disable Housing Speaker</i> .....	44
<i>CD Audio Connector</i> .....	45
<i>Modem Audio Connector</i> .....	46
<i>Battery-less and Long Life Design</i> .....	47
<i>Over-current Protection</i> .....	48

<i>Hardware Monitoring</i> .....	50
<i>Resettable Fuse</i> .....	51
<i>Year 2000 (Y2K)</i> .....	52
<i>Low ESR Capacitor</i> .....	54
<i>Layout (Frequency Isolation Wall)</i> .....	56
<b>Driver and Utility</b> .....	<b>57</b>
<i>Autorun Menu from Bonus CD Disc</i> .....	58
<i>Installing Windows 95</i> .....	59
<i>Installing Windows 98</i> .....	60
<i>Installing Windows NT</i> .....	61
<i>Installing VIA 4 in 1 Driver</i> .....	62
<i>Installing Onboard Sound Driver</i> .....	63
<i>Installing Hardware Monitoring Utility</i> .....	64
<i>ACPI Suspend to Hard Drive</i> .....	65
<i>ACPI Suspend to RAM (STR)</i> .....	72
<b>AWARD BIOS</b> .....	<b>74</b>

<i>Enter BIOS Setup</i> .....	75
<i>Change Language</i> .....	76
<i>Standard CMOS Setup</i> .....	77
<i>BIOS Features Setup</i> .....	83
<i>Chipset Features Setup</i> .....	93
<i>Power Management Setup</i> .....	100
<i>PNP/PCI Configuration Setup</i> .....	110
<i>Load Setup Defaults</i> .....	118
<i>Load Turbo Defaults</i> .....	119
<i>Integrated Peripherals</i> .....	120
<i>Password Setting</i> .....	132
<i>IDE HDD Auto Detection</i> .....	133
<i>Save &amp; Exit Setup</i> .....	135
<i>Load EEPROM Default</i> .....	136
<i>Save EEPROM Default</i> .....	136
<i>Exit without Saving</i> .....	136

NCR SCSI BIOS and Drivers .....	136
BIOS Upgrade .....	137
<b>Overclocking .....</b>	<b>138</b>
VGA and HDD .....	140
<b>Glossary .....</b>	<b>141</b>
AC97 .....	141
ACPI (Advanced Configuration & Power Interface) .....	141
AGP (Accelerated Graphic Port) .....	141
AMR (Audio/Modem Riser) .....	142
AOpen Bonus Pack CD .....	142
APM .....	142
ATA/66 .....	142
ATA/100 .....	143
BIOS (Basic Input/Output System) .....	143
Bus Master IDE (DMA mode) .....	143
CODEC (Coding and Decoding) .....	143

<i>DIMM (Dual In Line Memory Module)</i> .....	144
<i>ECC (Error Checking and Correction)</i> .....	144
<i>EDO (Extended Data Output) Memory</i> .....	144
<i>EEPROM (Electronic Erasable Programmable ROM)</i> .....	144
<i>EPROM (Erasable Programmable ROM)</i> .....	145
<i>FCC DoC (Declaration of Conformity)</i> .....	145
<i>FC-PGA</i> .....	145
<i>Flash ROM</i> .....	145
<i>FSB (Front Side Bus) Clock</i> .....	146
<i>I2C Bus</i> .....	146
<i>P1394</i> .....	146
<i>Parity Bit</i> .....	146
<i>PBSRAM (Pipelined Burst SRAM)</i> .....	146
<i>PC100 DIMM</i> .....	147
<i>PC133 DIMM</i> .....	147
<i>PDF Format</i> .....	147

<i>PnP (Plug and Play)</i> .....	147
<i>POST (Power-On Self Test)</i> .....	148
<i>RDRAM (Rambus DRAM)</i> .....	148
<i>RIMM</i> .....	148
<i>SDRAM (Synchronous DRAM)</i> .....	148
<i>SIMM (Single In Line Memory Module)</i> .....	149
<i>SMBus (System Management Bus)</i> .....	149
<i>SPD (Serial Presence Detect)</i> .....	149
<i>Ultra DMA/33</i> .....	149
<i>USB (Universal Serial Bus)</i> .....	150
<i>ZIP file</i> .....	150
<b>Troubleshooting</b> .....	<b>151</b>
<b>Technical Support</b> .....	<b>155</b>
<i>Part Number and Serial Number</i> .....	157
<i>Model name and BIOS version</i> .....	158



## Before You Start



This Online Manual is in [PDF format](#), we recommend using Adobe Acrobat Reader 4.0 for online viewing, it is included in [Bonus CD disc](#) or you can get free download from [Adobe web site](#).

Although this Online Manual is optimized for screen viewing, it is still capable for hardcopy printing, you can print it by A4 paper size and set 2 pages per A4 sheet on your printer. To do so, choose **File > Page Setup** and follow the instruction of your printer driver.

Thanks for the help of saving our earth.

## Quick Installation Procedure

This page gives you a quick procedure on how to install your system. Follow each step accordingly.

- 1** Installing [CPU](#) and [Fan](#)
- 2** [Installing System Memory \(DIMM\)](#)
- 3** [Connecting Front Panel Cable](#)
- 4** [Connecting IDE and Floppy Cable](#)
- 5** [Connecting ATX Power Cable](#)
- 6** [Connecting Back Panel Cable](#)
- 7** [Power-on and Load BIOS Setup Default](#)
- 8** [Setting CPU Frequency](#)
- 9** Reboot
- 10** [Installing Operating System \(such as Windows 98\)](#)
- 11** [Installing Driver and Utility](#)

**Motherboard Map**

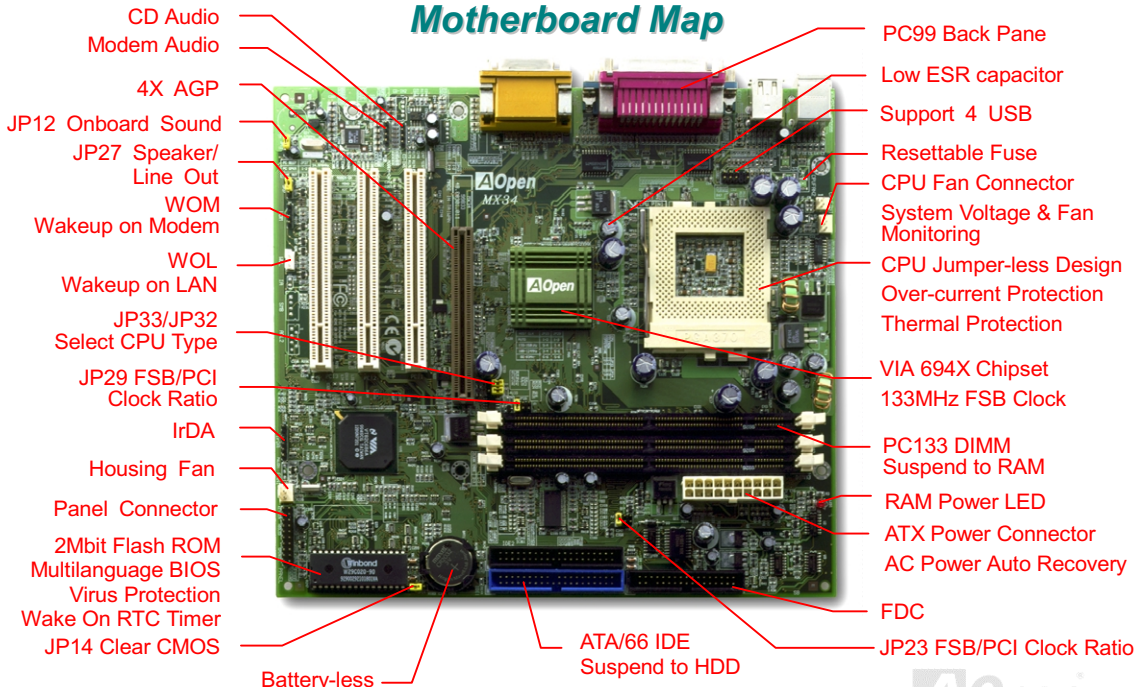

## Block Diagram

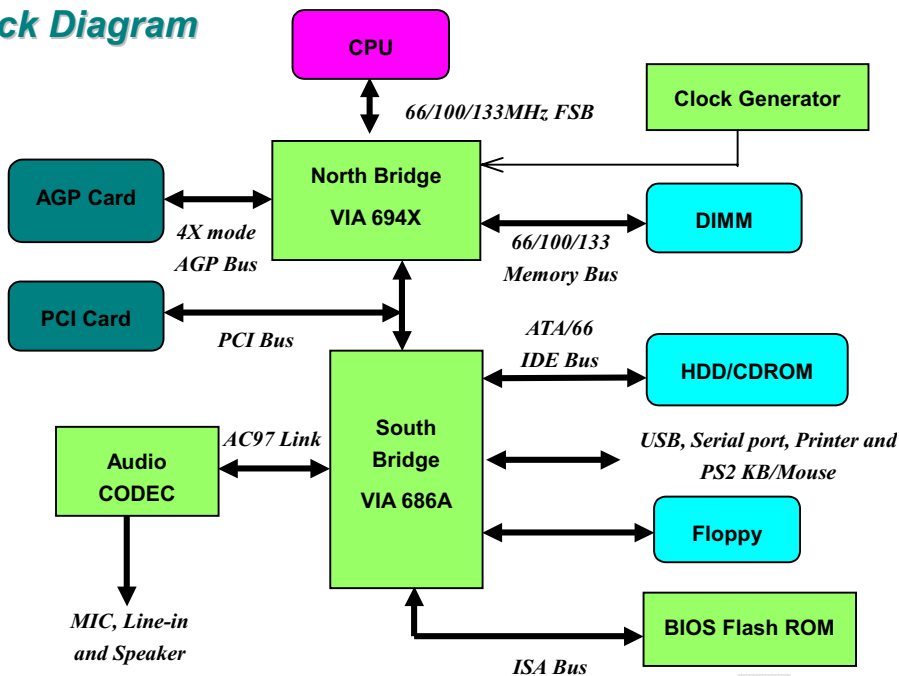

# Hardware

This chapter describes jumpers, connectors and hardware devices of this motherboard.



**Note:** *Electrostatic discharge (ESD) can damage your processor, disk drives, expansion boards, and other components. Always observe the following precautions before you install a system component.*

- 1. Do not remove a component from its protective packaging until you are ready to install it.*
- 2. Wear a wrist ground strap and attach it to a metal part of the system unit before handling a component. If a wrist strap is not available, maintain contact with the system unit throughout any procedure requiring ESD protection.*

## JP14 Clear CMOS

You can clear CMOS to restore system default setting. To clear the CMOS, follow the procedure below.

1. Turn off the system and unplug the AC power.
2. Remove ATX power cable from connector PWR2.
3. Locate JP14 and short pins 2-3 for a few seconds.
4. Return JP14 to its normal setting by shorting pins 1-2.
5. Connect ATX power cable back to connector PWR2.



### Tip: When should I Clear CMOS?

1. Boot fail because of overclocking...
2. Forget password...
3. Troubleshooting...



Normal Operation  
(default)



Clear CMOS

## CPU Socket

This motherboard supports Celeron, and Pentium III FC-PGA Socket370 CPU. Be careful of CPU orientation when you plug it into CPU socket.

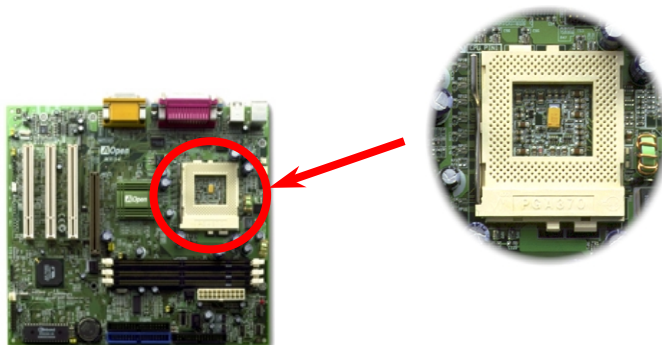

## CPU and Housing Fan Connector

Plug in the CPU fan cable to the 3-pin **CPUFAN** connector. If you have other housing fan, you can also plug it on **FAN** connector.

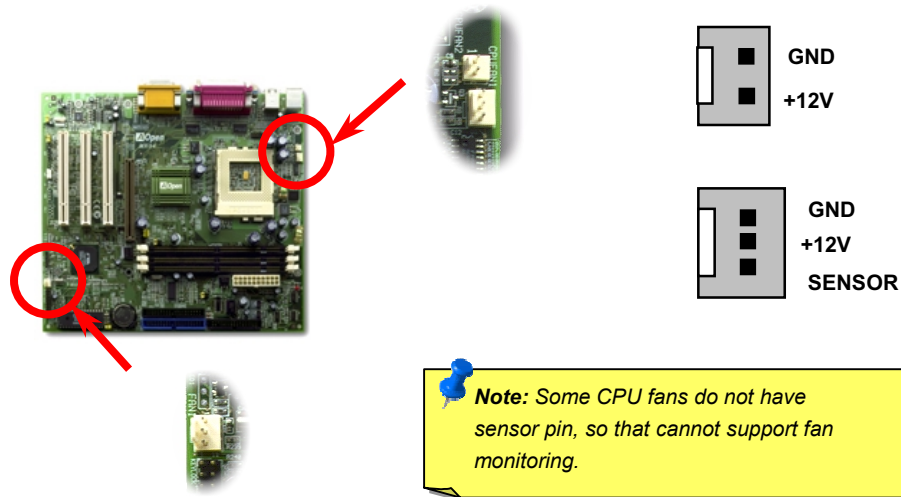



## CPU Jumper-less Design

CPU VID signal and [SMBus](#) clock generator provide CPU voltage auto-detection and allows the user to set the CPU frequency through the [BIOS setup](#), therefore no jumpers or switches are used. The correct CPU information is saved into the [EEPROM](#). With these technologies, the disadvantages of the Pentium based jumper-less designs are eliminated. There will be no worry of wrong CPU voltage detection and no need to re-open the housing in case of CMOS battery loss.

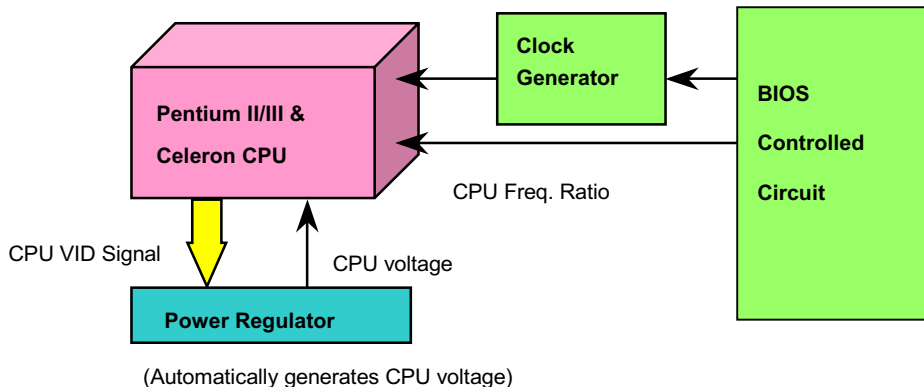

## Setting CPU Frequency

This motherboard is CPU jumper-less design, you can set CPU frequency through the BIOS setup, no jumpers or switches are needed.

**BIOS Setup > Chipset Features Setup > [CPU Clock Frequency](#)**

**BIOS Setup > Chipset Features Setup > [CPU Clock Ratio](#)**

<b>CPU Ratio</b>	1.5x, 2x, 2.5x, 3x, 3.5x, 4x, 4.5x, 5x, 5.5x, 6x, 6.5x, 7x, 7.5x, and 8x
<b>CPU <a href="#">FSB</a></b>	66.8, 75, 83.3, 100, 103, 105, 110, 112, 115, 120, 124, 133, 140, and 150 MHz.



**Warning:** VIA 694X chipset supports maximum 133MHz FSB and 66MHz AGP clock, higher clock setting may cause serious system damage.



**Tip:** If your system hangs or fails to boot because of overclocking, simply use <Home> key to restore the default setting (233MHz).



Home

**Core Frequency = CPU FSB Clock \* CPU Ratio**

CPU	CPU Core Frequency	FSB Clock	Ratio
Celeron 300A	300MHz =	66MHz	4.5x
Celeron 366	366MHz=	66MHz	5.5x
Celeron 366	366MHz=	66MHz	5.5x
Celeron 400	400MHz=	66MHz	6x
Pentium II 233	233MHz =	66MHz	3.5x
Pentium II 333	333MHz =	66MHz	5x
Pentium II 350	350MHz=	100MHz	3.5x
Pentium II 400	400MHz =	100MHz	4x
Pentium III 450	450MHz=	100MHz	4.5x
Pentium III 500	500MHz =	100MHz	5x
Pentium III 533EB	533MHz =	133MHz	4x
Pentium III 550E	550MHz =	100MHz	5.5x

Pentium III 600E	600MHz =	100MHz	6x
Pentium III 600EB	600MHz =	133MHz	4.5x
Pentium III 650E	650MHz =	100MHz	6.5x
Pentium III 667EB	667MHz =	133MHz	5x
Pentium III 700E	700MHz =	100MHz	7x
Pentium III 733EB	733MHz =	133MHz	5.5x

## JP29/JP23 FSB/PCI Clock Ratio

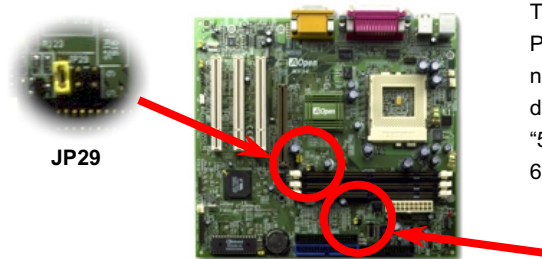

JP29

JP23

This jumper is used to specify the relationship of PCI and [FSB](#) clock. Generally speaking, if you are not overclockers, we recommend to set at the default setting. For example, you must set JP29 to "5-6" and JP23 to "3-4" if you want to overclock a 66MHz FSB clock CPU to 100MHz or higher.

	JP29	JP23		JP29	JP23		JP29	JP23		JP29	JP23	
1	○	○	○	○	○	○	○	○	○	○	○	○
2	○	○	○	○	○	○	○	○	○	○	○	○
5	○	○	○	○	○	○	○	○	○	○	○	○
6	○	○	○	○	○	○	○	○	○	○	○	○
	Auto (default)			4X (133~150MHz)			3X (100~124MHz)			2X (66~83MHz)		

**PCI Clock = CPU FSB Clock / Clock Ratio**

**AGP Clock = PCI Clock x 2**

Clock Ratio	CPU (Host)	PCI	AGP	Memory
2X	66	33	66	PCI x2 or x3
3X	100	33	66	PCI x2 or x3 or x4
3X, overclocking	112	37.3	74.6	PCI x2 or x3 or x4
4X	133	33	66	PCI x3 or x4
4X, overclocking	155	38.75	77.5	PCI x3 or x4



**Warning:** VIA 694X chipset supports maximum 133MHz FSB and 66MHz AGP clock, higher clock setting may cause serious system damage.

## JP33/JP32 Select CPU Type

This jumper is used to select various CPU type.

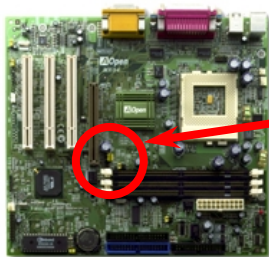

CPU Type	JP33	JP32
Coppermine	1-2	1-2
Celeron	2-3	1-2
Joshua	1-2	2-3

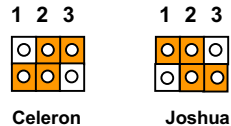
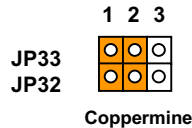

## DIMM Socket

This motherboard has three 168-pin [DIMM sockets](#) that allow you to install [PC133](#) memory up to 1.5GB. Only SDRAM is supported.



Pin 1

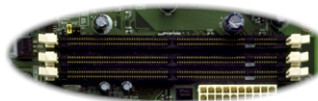

DIMM1  
DIMM2  
DIMM3

**Tip:** The driving capability of new generation chipset is limited due to the lack of a memory buffer (to improve performance). This makes DRAM chip count an important factor to take into consideration when you install DIMMs. Unfortunately, there is no way that the BIOS can identify the correct chip count, you need to calculate the chip count by yourself. The simple rule is: **By visual inspection, use only DIMMs which are less than 16 chips..**



DIMM can be single side or double side, it has 64 bit data and 2 or 4 clock signals. We strongly recommend choosing 4-clock SDRAM for its reliability



**Tip:** To identify 2-clock and 4-clock DIMM, you may check if there are traces connected to the golden finger pins 79 and 163 of the SDRAM. If there are traces, the SDRAM is probably 4-clock; otherwise, it is 2-clock.



**Tip:** To identify single-side or double-side DIMM, check golden finger pin 114 and pin 129. If there are traces connected to pin 114 and pin 129, the DIMM is probably double-side; otherwise, it is single-side.

## RAM Power LED

This LED indicates there is power applies to memory. It is useful to check RAM power during Suspend to RAM. Do not unplug memory module when this LED is On.

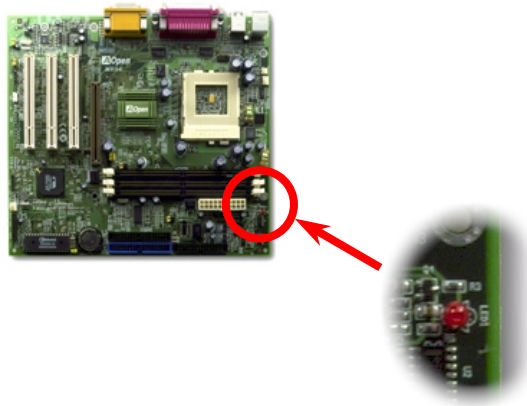

## Front Panel Connector

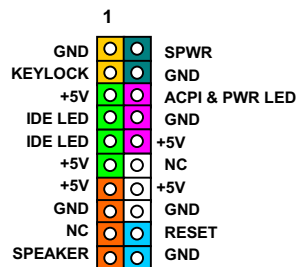
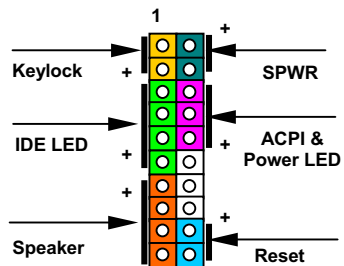
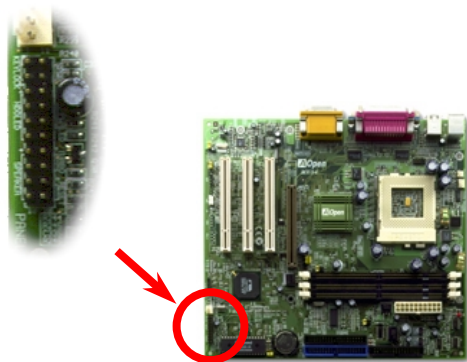

Attach the power LED, keylock, speaker, and reset switch connectors to the corresponding pins. If you enable Power Management > [Suspend Mode](#) in BIOS Setup, the ACPI & Power LED will keep flashing while the system is in suspend mode.

Suspend Type	ACPI LED
Power on Suspend (S1)	Flashing for every second
Suspend to RAM (S3)	Flashing for every 4 seconds

Locate the power switch cable from your ATX housing. It is 2-pin female connector from the housing front panel. Plug this connector to the soft-power switch connector marked **SPWR**.

## ATX Power Connector

The ATX power supply uses 20-pin connector shown below. Make sure you plug in the right direction.

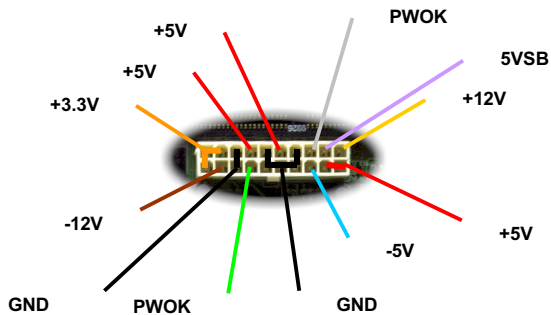
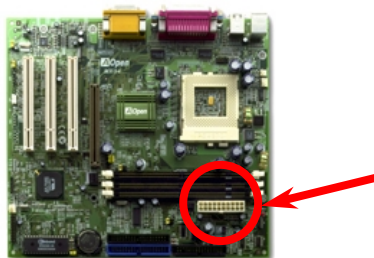

## AC Power Auto Recovery

A traditional ATX system should remain at power off stage when AC power resumes from power failure. This design is inconvenient for a network server or workstation, without an UPS, that needs to keep power-on. This motherboard implements an AC Power Auto Recovery function to solve this problem. If BIOS Setup > Power management > [AC PWR Auto Recovery](#) is set to "On" the system will automatically power-on after AC power resumes.

## IDE and Floppy Connector

Connect 34-pin floppy cable and 40-pin IDE cable to floppy connector FDC and IDE connector. The **blue connector** is IDE1 for clear identification. Be careful of the pin1 orientation. Wrong orientation may cause system damage.



IDE2 (Secondary)

IDE1 (Primary)

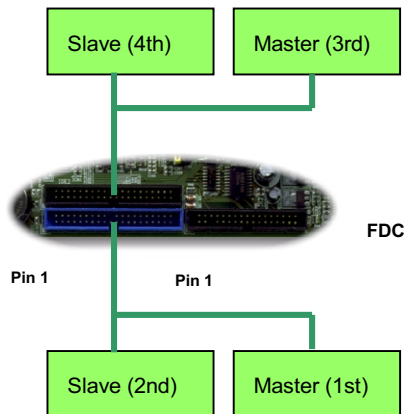

IDE1 is also known as the primary channel and IDE2 as the secondary channel. Each channel supports two IDE devices that make a total of four devices. In order to work together, the two devices on each channel must be set differently to **master** and **slave** mode. Either one can be the hard disk or the CDROM. The setting as master or slave mode depends on the jumper on your IDE device, so please refer to your hard disk and CDROM manual accordingly.



**Warning:** *The specification of the IDE cable is a maximum of 46cm (18 inches), make sure your cable does not exceed this length.*



**Tip:** *For better signal quality, it is recommended to set the far end side device to master mode and follow the suggested sequence to install your new device. Please refer to above diagram.*



This motherboard supports [ATA/66 IDE](#). Following table lists the transfer rate of IDE PIO and DMA modes. The IDE bus is 16-bit, which means every transfer is two bytes.

Mode	Clock Period	Clock Count	Cycle Time	Data Transfer Rate
PIO mode 0	30ns	20	600ns	$(1/600\text{ns}) \times 2\text{byte} = 3.3\text{MB/s}$
PIO mode 1	30ns	13	383ns	$(1/383\text{ns}) \times 2\text{byte} = 5.2\text{MB/s}$
PIO mode 2	30ns	8	240ns	$(1/240\text{ns}) \times 2\text{byte} = 8.3\text{MB/s}$
PIO mode 3	30ns	6	180ns	$(1/180\text{ns}) \times 2\text{byte} = 11.1\text{MB/s}$
PIO mode 4	30ns	4	120ns	$(1/120\text{ns}) \times 2\text{byte} = 16.6\text{MB/s}$
DMA mode 0	30ns	16	480ns	$(1/480\text{ns}) \times 2\text{byte} = 4.16\text{MB/s}$
DMA mode 1	30ns	5	150ns	$(1/150\text{ns}) \times 2\text{byte} = 13.3\text{MB/s}$
DMA mode 2	30ns	4	120ns	$(1/120\text{ns}) \times 2\text{byte} = 16.6\text{MB/s}$
UDMA/33	30ns	4	120ns	$(1/120\text{ns}) \times 2\text{byte} \times 2 = 33\text{MB/s}$
UDMA/66	30ns	2	60ns	$(1/60\text{ns}) \times 2\text{byte} \times 2 = 66\text{MB/s}$
UDMA/100	20ns	2	40ns	$(1/40\text{ns}) \times 2\text{byte} \times 2 = 100\text{MB/s}$



**Tip:** To achieve the best performance of Ultra DMA/66 hard disks, a special **80-wires IDE cable** for Ultra DMA/66 is required..

## IrDA Connector

The IrDA connector can be configured to support wireless infrared module, with this module and application software such as Laplink or Windows 95 Direct Cable Connection, the user can transfer files to or from laptops, notebooks, PDA devices and printers. This connector supports HPSIR (115.2Kbps, 2 meters) and ASK-IR (56Kbps).



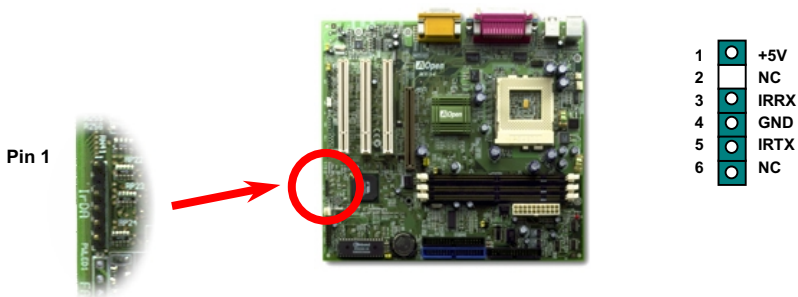

Install the infrared module onto the **IrDA** connector and enable the infrared function from BIOS Setup, [UART 2 Mode](#), make sure to have the correct orientation when you plug in the IrDA connector.



## WOM (Zero Voltage Wake on Modem)

This motherboard implements special circuit to support Wake On Modem, both Internal modem card and external box modem are supported. Since Internal modem card consumes no power when system power is off, it is recommended to use an internal modem. To use internal modem, connect 4-pin cable from **RING** connector of modem card to the **WOM** connector on the motherboard.

1

	+5V Standby
	NC
	RING
	GND

Pin 1

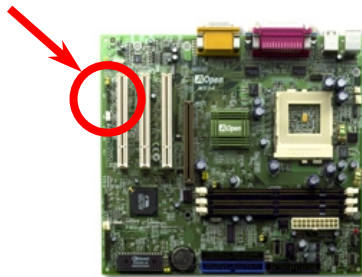

## WOM by External BOX Modem

Traditional Green PC suspend mode does not really turn off the system power supply, it uses external box modem to trigger MB COM port and resume back to active.

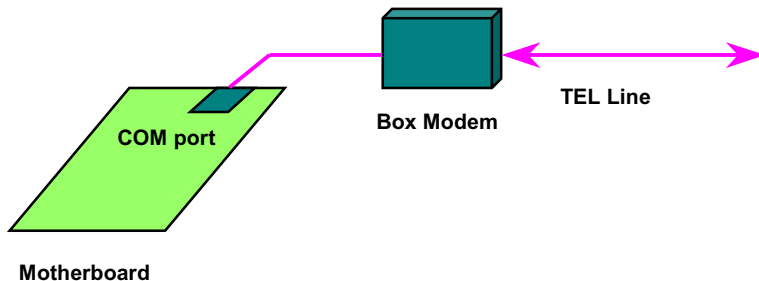

## WOM by Internal Modem Card

With the help of the ATX soft power On/Off, it is possible to have a system totally power off, and wakeup to automatically answer a phone call as an answering machine or to send/receive a fax. You may identify whether or not your system is in true power off mode by checking to see if the fan of your power supply is off. Both an external box modem and an internal modem card can be used to support Modem Wake Up, but if you use an external modem, you have to leave your box modem on.

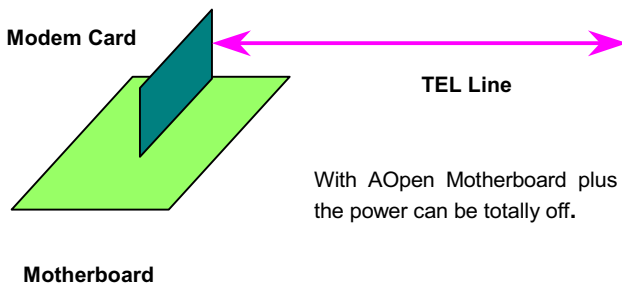

With AOpen Motherboard plus AOpen Modem Card, the power can be totally off.

## WOL (Wake on LAN)

This feature is very similar as [Wake On Modem](#), but it goes through local area network. To use Wake On LAN function, you must have a network card with chipset that supports this feature, and connect a cable from LAN card to motherboard WOL connector. The system identification information (probably IP address) is stored on network card and because there is a lot of traffic on the Ethernet, you need to install a network management software, such as ADM, for the checking of how to wake up the system. Note that, at least 600mA ATX standby current is required to support the LAN card for this function.



+5V Standby

GND

LID

Pin 1



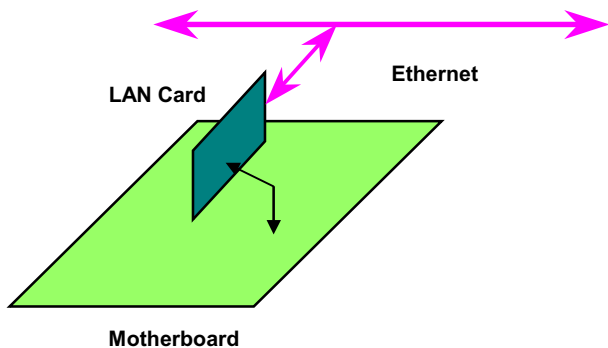

## 4X AGP (Accelerated Graphic Port)

This motherboard supports 4X [AGP](#). AGP is a bus interface designed for high-performance 3D graphic and supports only memory read/write operation. One motherboard can only have one AGP slot. **2X AGP** uses both rising and falling edge of the 66MHz clock, the data transfer rate is  $66\text{MHz} \times 4 \text{ bytes} \times 2 = 528\text{MB/s}$ . **4X AGP** is still using 66MHz AGP clock but the it has 4 data transfers within one 66MHz clock cycle, so that the data transfer rate is  $66\text{MHz} \times 4 \text{ bytes} \times 4 = 1056\text{MB/s}$ .

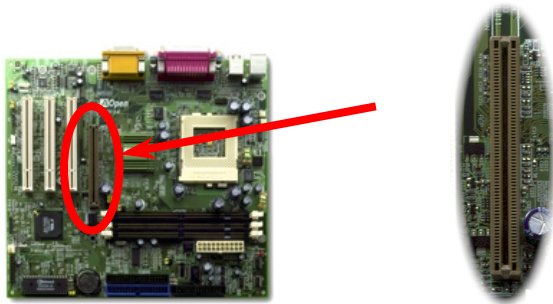



## PC99 Color Coded Back Panel

The onboard I/O devices are PS/2 Keyboard, PS/2 Mouse, serial ports COM1 and COM2, Printer, [four USB](#), AC97 sound and Game port. The view angle of drawing shown here is from the back panel of the housing.

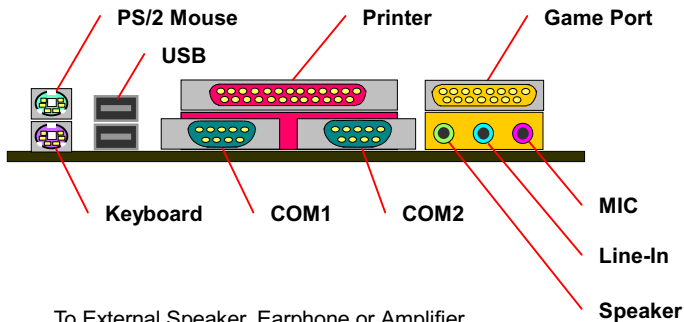

**Speaker:** To External Speaker, Earphone or Amplifier.

**Line-In:** From signal source such as CD/Tape player.

**MIC:** From Microphone

## Support 4 USB Ports

This motherboard supports four USB ports. Two of them are on back panel connector, the other two are on the left-bottom area of this motherboard. With proper cable, you can connect them to front panel.

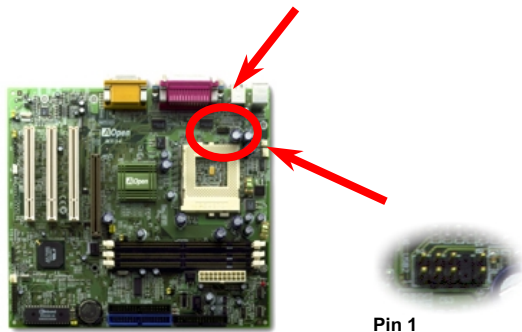
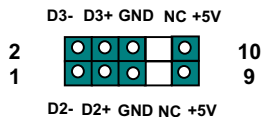

## JP12 Enable/Disable Onboard Sound

This motherboard has [AC97](#) sound onboard. JP12 is used to enable or disable onboard AD1881 [CODEC](#) chip. If you select Disable, you can use your preferred PCI sound card.



Enable



Disable

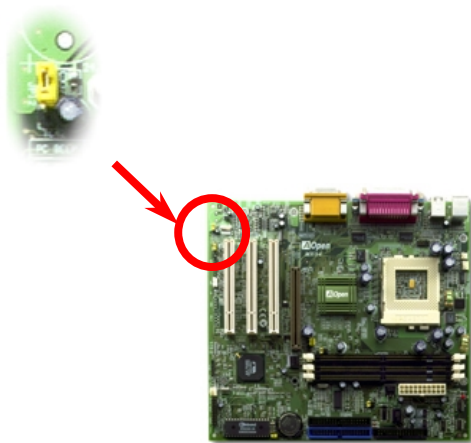

## JP27 Enable/Disable Housing Speaker

This jumper is used to enable or disable housing speaker.

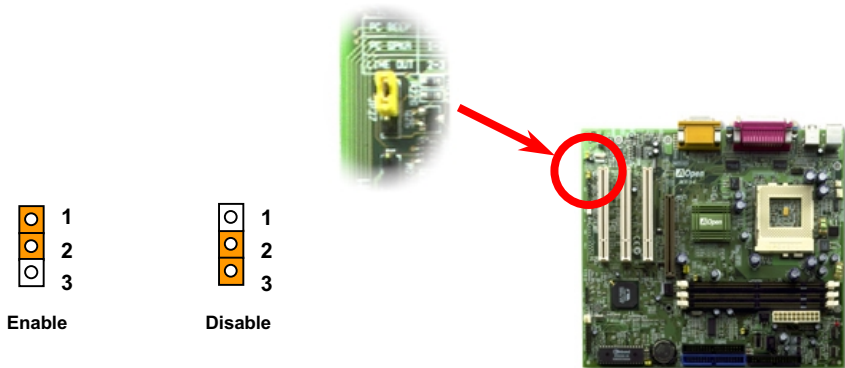





## CD Audio Connector

This connector is used to connect CD Audio cable from CDROM or DVD drive to onboard sound.

Pin 1



CD-IN

1		L
2		GND
3		GND
4		R



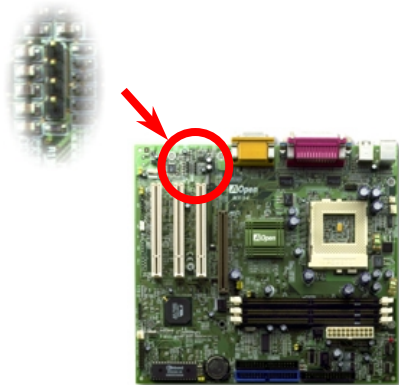

## Modem Audio Connector

This connector is used to connect Mono In/Mic Out cable from internal modem card to onboard sound circuit. The pin 1-2 is **Mono In**, and the pin 3-4 is **Mic Out**. Please note that there is no standard for this kind of connector yet, only some internal modem cards implement this connector.

Pin 1



MODEM-CN

- |   |   |                      |
|---|---|----------------------|
| 1 |  | Mono In (to modem)   |
| 2 |  | GND                  |
| 3 |  | GND                  |
| 4 |  | Mic Out (from Modem) |

## Battery-less and Long Life Design

This Motherboard implements [EEPROM](#) and a special circuit that allows you to save your current CPU and CMOS Setup configurations without the need of a battery. The RTC (real time clock) can also keep running as long as the power cord is plugged. If you lose your CMOS data by accident, you can just reload the CMOS configurations from EEPROM and the system will recover as usual.

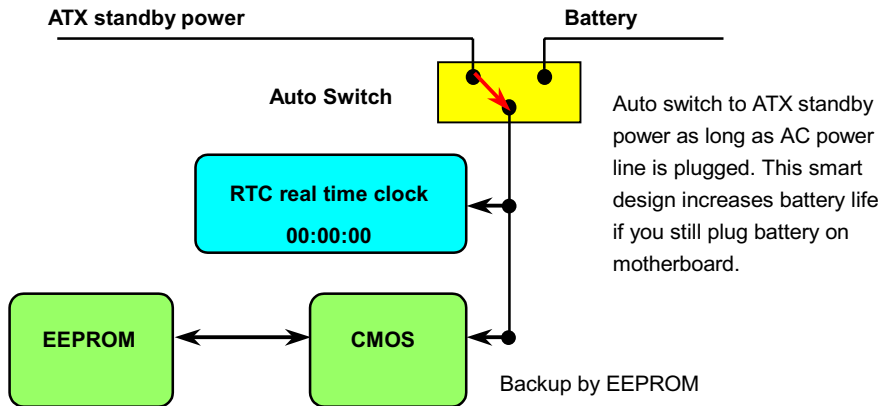

## Over-current Protection

The Over Current Protection was very popular implemented on ATX 3.3V/5V/12V switching power supply. However, the new generation CPU uses different voltage that has regulator to transfer 5V to CPU voltage (for example, 2.0V), and makes 5V over current protection useless. This motherboard with switching regulator onboard support CPU over-current protection, in conjunction with 3.3V/5V/12V power supply provide the full line over-current protection.

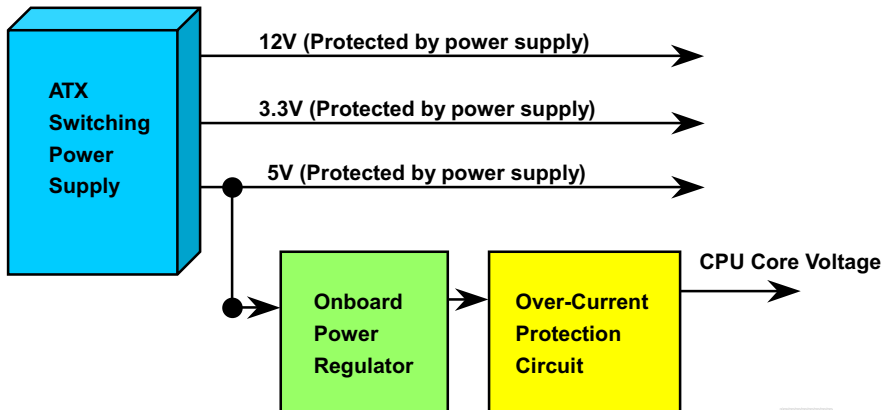





**Note:** Although we have implemented protection circuit try to prevent any human operating mistake, there is still certain risk that CPU, memory, HDD, add-on cards installed on this motherboard may be damaged because of component failure, human operating error or unknown nature reason. **AOpen cannot guaranty the protection circuit will always work perfectly.**

## Hardware Monitoring

This motherboard implements a hardware monitoring system. As you turn on your system, this smart design will continue to monitor your system's working voltage, fan status and CPU temperature. If any of these system's status go wrong, there will be an alarm through the AOpen [Hardware Monitoring Utility](#) to warn the user.

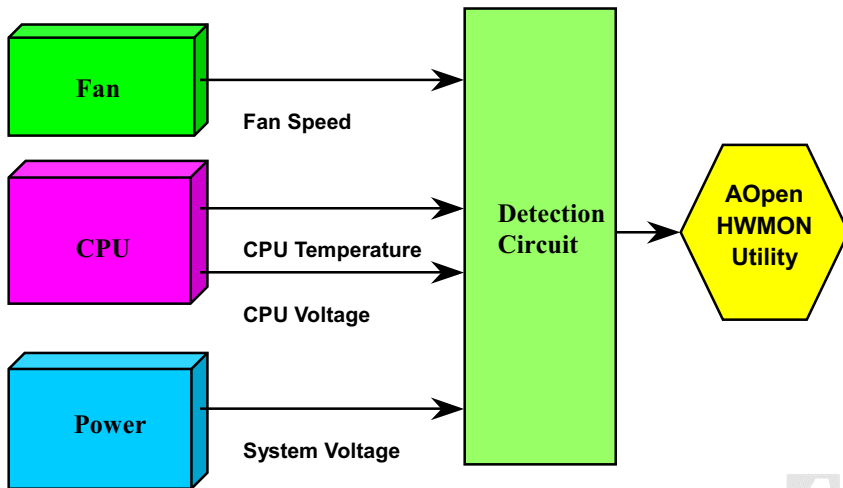

## Resettable Fuse

Traditional motherboard has fuse for Keyboard and [USB](#) port to prevent over-current or shortage. These fuses are soldered onboard that when it is broken (did the job to protect motherboard), user still cannot replace it and the motherboard is still malfunction.

With expensive Resettable Fuse, the motherboard can back to normal function after fuse did the protection job.

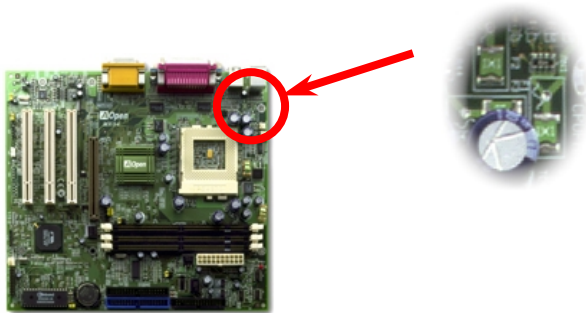

## Year 2000 (Y2K)

Y2K is basically a problem of the identification of year code. To save storage space, traditional software uses only two digits for year identification. For example, 98 for 1998 and 99 for 1999, but 00 will be confused with 1900 and 2000.

There is an RTC circuit (Real Time Clock) in conjunction with 128 bytes of CMOS RAM data in the chipset of the motherboard. The RTC has only two digits and the CMOS has another 2 digits.

Unfortunately, this circuit's behavior is like this 1997 → 1998 → 1999 → 1900, that means it may have the Y2K problem. Below is a diagram of how applications work with the OS, BIOS and RTC. In order to keep the best compatibility in the PC industry there is a rule that applications must call the OS to get services and OS must call the BIOS, and then only BIOS is allowed to access the hardware (RTC) directly.

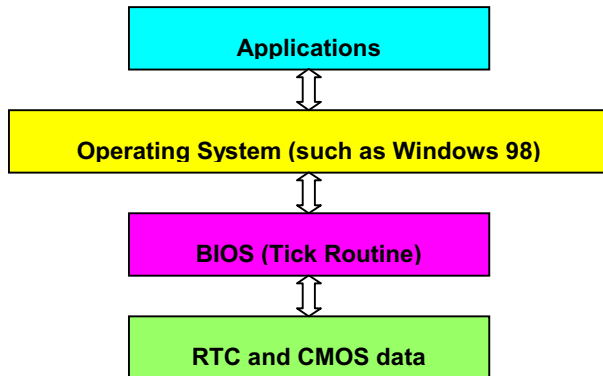

There is a Tick Routine (that goes live around every 50m sec) in the BIOS to keep record of date/time information. In general the BIOS, this Tick Routine does not update the CMOS every time because the CMOS is a very slow device which degrades system performance. The Tick Routine of the AOpen BIOS has 4 digits for year coding, as long as applications and the operating system follow the rule to get date/time information. There will be no Y2K problem (such as NSTL's test program). But unfortunately again, we found some test programs (such as Checkit 98) accesses RTC/CMOS directly. **This motherboard has hardware Y2K checking and protection that ensures risk free operation.**

## Low ESR Capacitor

The quality of low ESR capacitor (Low Equivalent Series Resistor) during high frequency operation is very important for stability of CPU power. The location of where to put these capacitors is another know-how that requires experience and detail calculation.

Not only that, this motherboard implements **Low ESR capacitors**, which is much larger than normal (1000uF) and provide better stability for CPU power.



The power circuit of the CPU core voltage must be checked to ensure system stability for high speed CPUs (such as the new Pentium III, or when overclocking). A typical CPU core voltage is 2.0V, so a good design should control voltage between 1.860V and 2.140V. That is, the transient must be below 280mV. Below is a timing diagram captured by a Digital Storage Scope, it shows the voltage transient is only 143mv even when maximum 18A current is applied.

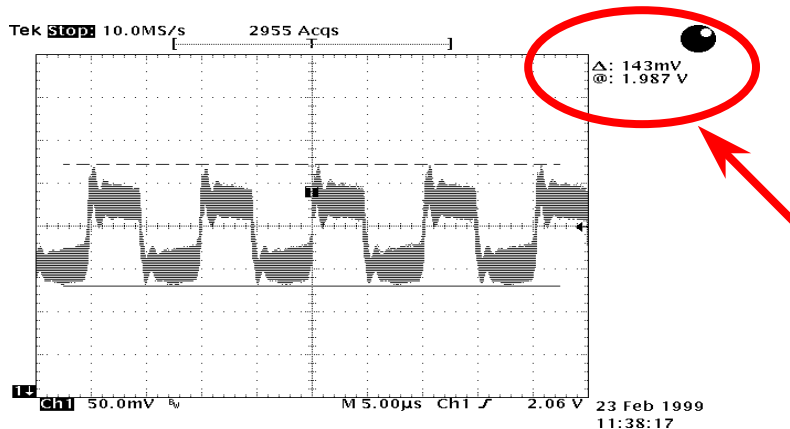

## Layout (Frequency Isolation Wall)

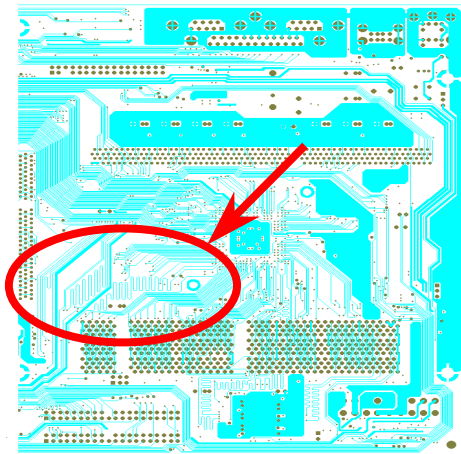

Note: This diagram for example only, it may not be exactly the same as this motherboard.

For high frequency operation, especially overclocking, layout is the most important factor to make sure chipset and CPU working in stable condition. The layout of this motherboard implements AOpen's unique design called "Frequency Isolation Wall". Separating each critical portion of motherboard into regions where each region operates in a same or similar frequency range to avoid crosstalk and frequency interference between each region's operations and condition. The trace length and route must be calculated carefully. For example, the clock trace must be equal length (not necessarily as short as possible) so that clock skew will be controlled within few a pico second ( $1/10^{12}$  Sec)



## Driver and Utility

There are motherboard drivers and utilities included in [AOpen Bonus CD disc](#). You don't need to install all of them in order to boot your system. But after you finish the hardware installation, you have to install your operation system first (such as Windows 98) before you can install any drivers or utilities. Please refer to your operation system's installation guide.



**Note:** Please follow recommended procedure to install [Windows 95](#) and [Windows 98](#).

## Autorun Menu from Bonus CD Disc

You can use the autorun menu of Bonus CD disc. Choose the utility and driver and select model name.

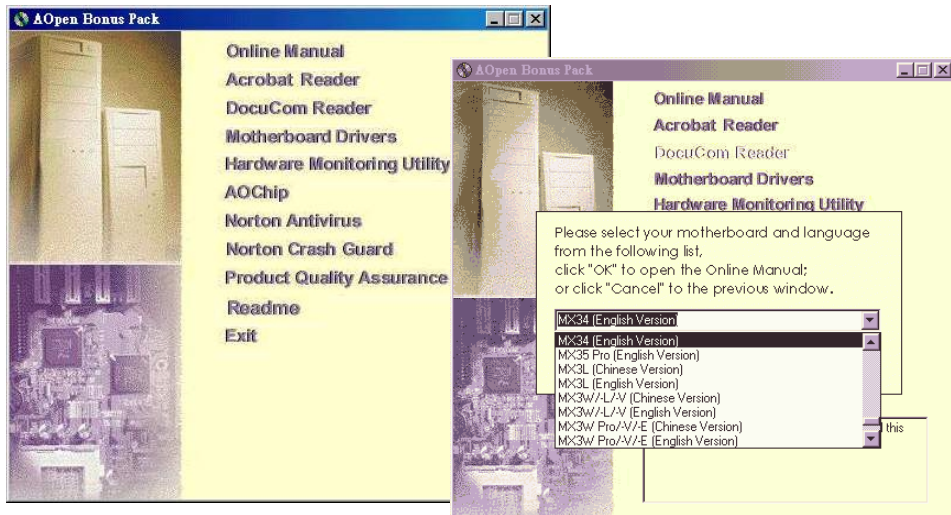

## Installing Windows 95

1. First, don't install any add-on card except [AGP](#) card.
2. Install Windows 95 OSR2 v2.1, 1212 or 1214 version and later with USB support. Otherwise, you need to install USBSUPP.EXE.
3. Install the [VIA 4 in 1 driver](#), which includes VIA AGP Vxd driver, IRQ routing driver, and VIA chipset function registry program.
4. Finally, Install other add-on cards and their drivers.

## Installing Windows 98

1. First, don't install any add-on card except [AGP](#) card.
2. Enable USB Controller in BIOS Setup > Integrated Peripherals > [OnChip USB](#), to make BIOS fully capable of controlling IRQ assignment.
3. Install Window 98 into your system.
4. Install the [VIA 4 in 1 driver](#), which includes VIA AGP Vxd driver, IRQ routing driver, and VIA chipset function registry program.
5. Finally, Install other add-on cards and their drivers.

## ***Installing Windows NT***

It is not necessary to install VIA 4 in 1 driver, just follow the installation guide of NT and your add-on cards

## Installing VIA 4 in 1 Driver

You can install the VIA 4 in 1 driver ( [IDE Bus master](#), VIA [AGP](#), IRQ Routing Driver, VIA Registry ) from the Bonus Pack CD disc autorun menu.

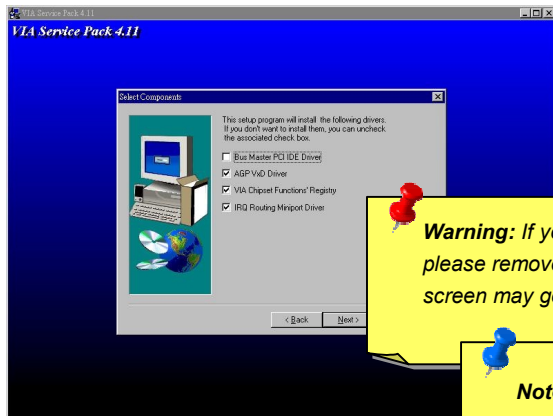

**Warning:** If you want to uninstall the VIA AGP Vxd driver, please remove the AGP card driver first. Otherwise, the screen may go black at rebooting after the un-installation.

**Note:** Installing this Bus Master IDE driver may cause Suspend to Hard Drive failure.

## Installing Onboard Sound Driver

This motherboard comes with an AD 1881 [AC97 CODEC](#) and the sound controller is in VIA South Bridge chipset. You can find the audio driver from the Bonus Pack CD disc autorun menu.

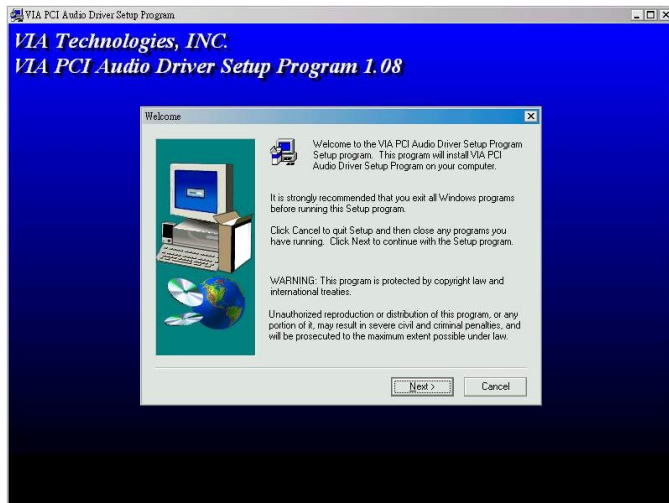

## Installing Hardware Monitoring Utility

You can install Hardware Monitoring Utility to monitor CPU temperature, fans and system voltage. The hardware monitoring function is automatically implemented by the BIOS and utility software, no hardware installation is needed.

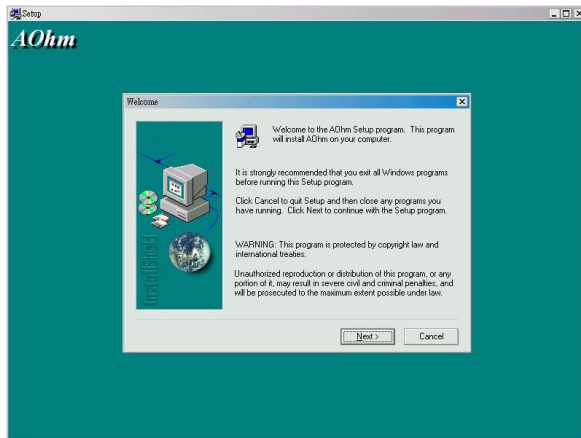



## ***ACPI Suspend to Hard Drive***

[ACPI](#) Suspend to Hard Drive is basically controlled by Windows operation system. It saves your current work (system status, memory and screen image) into hard disk, and then the system can be totally power off. Next time, when power is on, you can resume your original work directly from hard disk within few seconds without go through the Windows booting process and run your application again. If your memory is 64MB, normally, you need to reserve at least 64MB HDD space to save your memory image.

When go into Suspend:

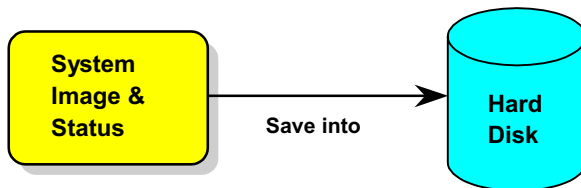

When power-on next time:

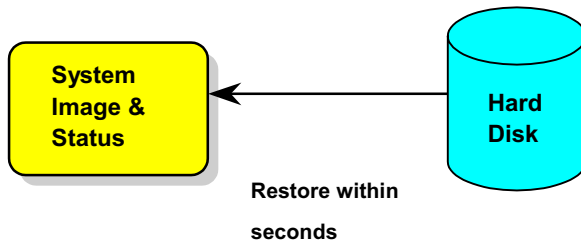

## System Requirement

1. **AOZVHDD.EXE 1.30b** or later.
2. Delete **config.sys** and **autoexec.bat**.

## Fresh installation of Windows 98 on a new system

1. Execute "**Setup.exe /p j**" to install Windows 98
2. After Windows 98's installation is complete, go to the Control Panel > Power Management.
  - a. Set Power Schemes > System Standby to "Never".
  - b. Click on "Hibernate" and select "Enable Hibernate Support" then "Apply".
  - c. Click on the "Advanced" tab, you'll see "Hibernate" on "Power Buttons". Note that this option will only be seen after step b mentioned above has been completed, otherwise only "Standby" and "Shutdown" will be shown. Select "Hibernate" and "Apply".
1. Clean boot into DOS and run AOZVHDD utility.
  - a. If you assign the whole disk to your Win 98 system (FAT 16 or FAT 32), please run "**aozvhd /c /file**". Please remember sufficient free space has to be reserved in the disk, e.g. if you have 64 MB DRAM and 16 MB VGA card installed, the system needs at least 80 MB free space. The utility will locate the space automatically.

- b. If you assign an individual partition for Win 98, please run "**aozvhd /c /partition**". Of course, the system needs to provide unformatted an empty partition.
2. Reboot system.
3. You've already implemented ACPI Suspend to-Hard Drive. Click "**Start > Shut Down > Standby**" then the screen will go off immediately. And 1 minute or so will be taken for the system to save what's in the memory to the hard drive; the larger the memory size the longer this process will take.

## Changing from APM to ACPI (Windows 98 only)

### 1. Run "Regedit.exe"

- a. Go through the following path

HKEY\_LOCAL\_MACHINE

SOFTWARE

MICROSOFT

WINDOWS

CURRENT VERSION

DETECT

- b. Select "ADD Binary" and name it as "**ACPIOPTION**".
- c. Right click and select Modify, add "01" after "0000" to make it "0000 01".
- d. Save changes.

2. Select "Add New Hardware" under Control Panel. Allow Windows 98 to detect new hardware. (It will find "**ACPI BIOS**" and remove "**Plug and Play BIOS**")

3. Reboot system.

4. Clean boot into DOS and run "AOZVHDD.EXE /C /File"

## Changing from ACPI to APM

### 1. Run "Regedit.exe"

- a. Go through the following path

HKEY\_LOCAL\_MACHINE

SOFTWARE

MICROSOFT

WINDOWS

CURRENT VERSION

DETECT

ACPI OPTION

- b. Right click and select "Modify, change "01" to "00" to make it "0000 02".

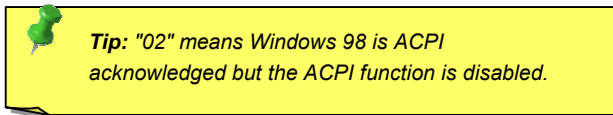

- c. Save changes.

2. Select "Add New Hardware" under Control Panel. Allow Windows 98 to detect new hardware. (It will find "**Plug and Play BIOS**" and remove "**ACPI BIOS**")
3. Reboot system.
4. Run "Add New Hardware" again and it will find "Advanced Power Management Resource".
5. Click "OK".



*Tip: Currently we found only ATI 3D Rage Pro AGP card would support ACPI suspend to disk. Please refer to AOpen web site for latest update.*

## ACPI Suspend to RAM (STR)

This motherboard supports ACPI Suspend to RAM function. With this function, you can resume your original work directly from DRAM without going through the Windows 98 booting process and run your application again. Suspend to DRAM saves your current work in the system memory, it is faster than Suspend to Hard Drive but requires power supplied to DRAM, while Suspend to Hard Drive requires no power.

### When go into Suspend:

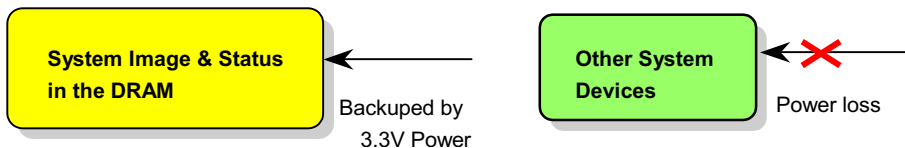

### When power-on next time:

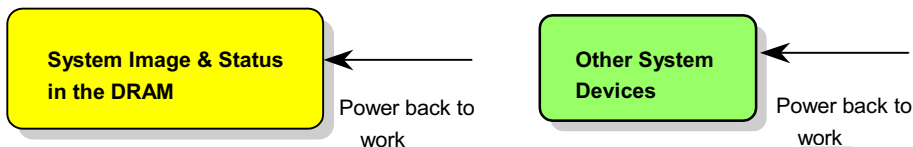



To implement ACPI Suspend to DRAM, please follow the procedures as below:

## System Requirement

1. An ACPI OS is required. Currently, Windows 98 is the only choice. Please refer to [ACPI Suspend to Hard Drive](#) of how to setup Windows 98 ACPI mode.
2. The VIA 4 in 1 Driver must have been installed properly.

## Procedures

1. Changed the following BIOS settings.

BIOS Setup > Power Management > [ACPI Function](#) : Enabled

BIOS Setup > Power Management > [ACPI Suspend Type](#) :S3.

2. Go to Control Panel > Power Management. Set "Power Buttons" to "Standby".
3. Press power button or standby button to wake up the system.

# AWARD BIOS

System parameters can be modified by going into [BIOS](#) Setup menu, this menu allows you to configure the system parameters and save the configuration into the 128 byte CMOS area, (normally in the RTC chip or in the main chipset). [To enter to BIOS setup menu](#), press <Del> when [POST \(Power-On Self Test\)](#) screen is shown on your monitor.

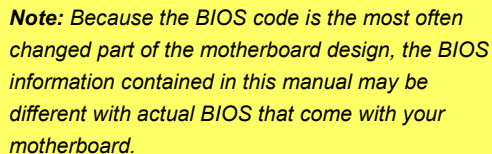

**Note:** Because the BIOS code is the most often changed part of the motherboard design, the BIOS information contained in this manual may be different with actual BIOS that come with your motherboard.

## Enter BIOS Setup



After you finish the setting of jumpers and connect correct cables. Power on and enter the BIOS Setup, press <Del> during [POST \(Power-On Self Test\)](#). Choose "[Load Setup Defaults](#)" for recommended optimal performance.

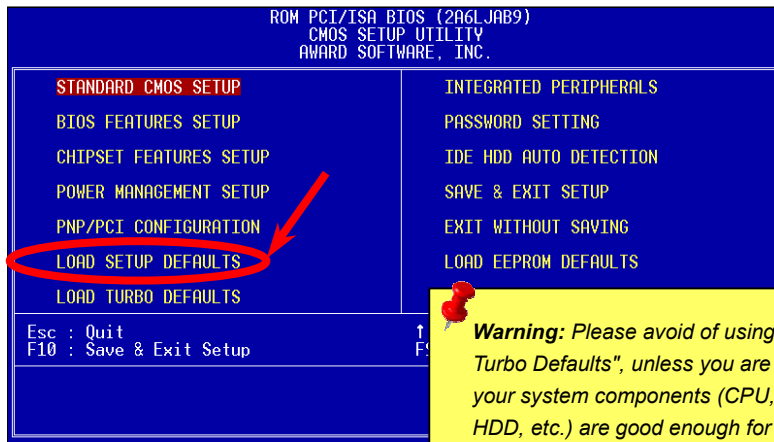

**Warning:** Please avoid of using "Load Turbo Defaults", unless you are sure your system components (CPU, DRAM, HDD, etc.) are good enough for turbo setting.

## Change Language

**F9**

You can change language by press <F9>. Depends on available BIOS space, the possible languages are English, German, Japanese and Chinese.

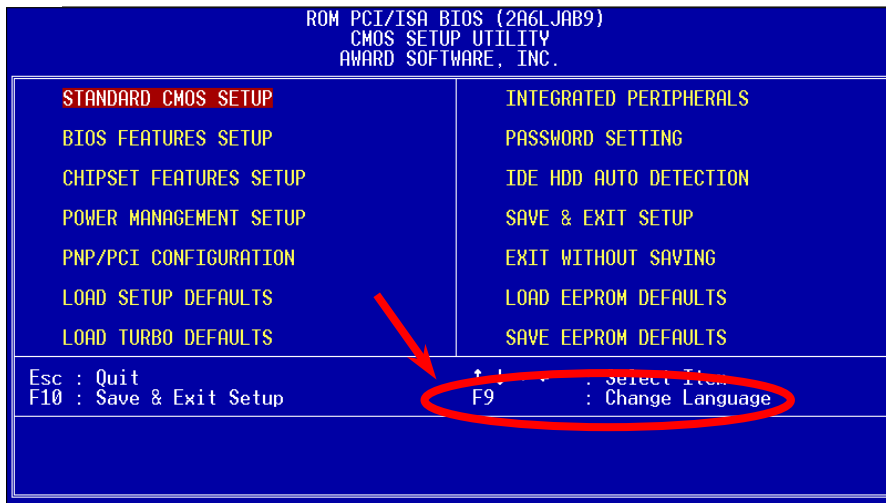

## Standard CMOS Setup



The "Standard CMOS Setup" sets the basic system parameters such as the date, time, and the hard disk type. Use the arrow keys to highlight an item and <PgUp> or <PgDn> to select the value for each item.



```

ROM PCI/ISA BIOS (00000006)
STANDARD CMOS SETUP
AWARD SOFTWARE, INC.

Date (mm:dd:yy) : Wed, Mar 15 1997
Time (hh:mm:ss) : 11 : 33 : 49

HARD DISKS      TYPE      SIZE  CYLS  HEAD  PRECOMP  LANDZ  SECTOR  MODE
-----
Primary Master  : 0        0      0     0     0        0     0     0 NORMAL
Primary Slave   : 0        0      0     0     0        0     0     0 NORMAL
Secondary Master : 0        0      0     0     0        0     0     0 NORMAL
Secondary Slave : 0        0      0     0     0        0     0     0 NORMAL

Drive A : None
Drive B : None

Video : EGA/VGA
Halt On : ALL Errors

ESC : Quit          ↑ ↓ + - : Select Item      PU/PD/+/- : Modify
F1  : Help          F9      : Change Language

```



### **Standard CMOS Setup > Date (mm:dd:yy)**

To set the date, highlight the Date parameter. Press <PgUp> or <PgDn> to set the current date. The date format is month, date, and year.

### **Standard CMOS Setup > Time (hh:mm:ss)**

To set the time, highlight the Time parameter. Press <PgUp> or <PgDn> to set the current time in hour, minute, and second format. The time is based on the 24 hour military clock.

Standard CMOS Setup > Primary Master > Type

Standard CMOS Setup > Primary Slave > Type

Standard CMOS Setup > Secondary Master > Type

Standard CMOS Setup > Secondary Slave > Type

**Type**

Auto

User

None

This item lets you select the IDE hard disk parameters that your system supports. These parameters are Size, Number of Cylinder, Number of Head, Start Cylinder for Pre-compensation, Cylinder number of Head Landing Zone and Number of Sector per Track. The default setting is **Auto**, which enables BIOS to automatically detect the parameters of installed HDD (Hard Disk Drive) at [POST](#) (Power-On Self Test). If you prefer to enter HDD parameters manually, select **User**. Select **None** if no HDD is connected to the system.

The IDE CDROM is always automatically detected.



**Tip:** For an IDE hard disk, we recommend that you use the "[IDE HDD Auto Detection](#)" to enter the drive specifications automatically. See the section "[IDE HDD Auto Detection](#)".

**Standard CMOS Setup > Primary Master > Mode**

**Standard CMOS Setup > Primary Slave > Mode**

**Standard CMOS Setup > Secondary Master > Mode**

**Standard CMOS Setup > Secondary Slave > Mode**

**Mode**

Auto  
Normal  
LBA  
Large

The enhanced IDE feature allows the system to use a hard disk with a capacity of more than 528MB. This is made possible through the Logical Block Address (LBA) mode translation. The LBA is now considered a standard feature of current IDE hard disk on the market because of its capability to support capacity larger than 528MB. Note that if a HDD is formatted with LBA On, it will not be able to boot with LBA Off.



### Standard CMOS Setup > Drive A

### Standard CMOS Setup > Drive B

**Drive A**

None

360KB 5.25"

1.2MB 5.25"

720KB 3.5"

1.44MB 3.5"

2.88MB 3.5"

These items select the floppy drive type. The available settings and types supported by the motherboard are listed to the left.

### Standard CMOS Setup > Video

**Video**

EGA/VGA

CGA40

CGA80

Mono

This item specifies the type of video card in use. The default setting is EGA/VGA. Since current PCs use VGA only, this function is almost useless and may be disregarded in the future.

## Standard CMOS Setup > Halt On

**Halt On**

No Errors

All Errors

All, But  
Keyboard

All, But Diskette

All, But Disk/Key

This parameter enables you to control the system stops in case of Power-On Self Test ([POST](#)) error.

## BIOS Features Setup

This screen appears when you select the option "BIOS Features Setup" from the main menu.

```

ROM PCI/ISA BIOS (2A6LJAB9)
BIOS FEATURES SETUP
AWARD SOFTWARE, INC.

Virus Warning           : Enabled
External Cache         : Disabled
CPU L2 Cache ECC Checking : Enabled
Processor Number Feature : Enabled
Quick Power On Self Test : Disabled
Boot Sequence          : A,C,SCSI
Swap Floppy Drive      : Disabled
Boot Up Floppy Seek    : Disabled
Boot Up NumLock Status : Off
Memory Parity/ECC Check : Disabled
Typematic Rate Setting : Disabled
Typematic Rate (Chars/Sec) : 6
Typematic Delay (Msec) : 250
Security Option        : Setup
PCI/VGA Palette Snoop  : Disabled
OS Select For DRAM > 64MB : Non-OS2
Show Logo On Screen    : Enabled

Video BIOS Shadow      : Disabled
C8000-CBFFF Shadow    : Disabled
CC000-CFFFF Shadow    : Disabled
D0000-D3FFF Shadow    : Disabled
D4000-D7FFF Shadow    : Disabled
D8000-DBFFF Shadow    : Disabled
DC000-DFFFF Shadow    : Disabled

ESC : Quit           ↑↓+* : Select Item
F1  : Help           PU/PD/+/- : Modify
F5  : Old Values     F9      : Language
F6  : Load Setup Defaults
F7  : Load Turbo Defaults
  
```

## BIOS Features Setup > Virus Warning

### Virus Warning

Enabled

Disabled

Set this parameter to Enabled to activate the warning message.

This feature protects the boot sector and partition table of your hard disk from virus intrusion. Any attempt during boot up to write to the boot sector of the hard disk drive stops the system and the following warning message appears on the screen. Run an anti-virus program to locate the problem.

### **! WARNING !**

Disk Boot Sector is to be modified  
Type "Y" to accept write, or "N" to abort write  
Award Software, Inc.

## BIOS Features Setup > External Cache

### External Cache

Enabled  
Disabled

Enabling this parameter activates the secondary cache. Disabling the parameter slows down the system. Therefore, we recommend that you leave it enabled unless you are troubleshooting a problem.

## BIOS Features Setup > CPU L2 Cache ECC Checking

### CPU L2 Cache ECC Checking

Enabled  
Disabled

This item lets you enable or disable L2 Cache [ECC](#) checking.

## BIOS Features Setup > Processor Number Feature

### Processor Number Feature

Enabled  
Disabled

This item is used to enable or disable Pentium III CPU Number Feature.

## BIOS Features Setup > Quick Power On Self Test

### **Quick Power on Self Test**

Enable

Disabled

This parameter speeds up [POST](#) by skipping some items that are normally checked.

## BIOS Features Setup > Boot Sequence

### **Boot Sequence**

A,C,SCSI

C,A,SCSI

C,CDROM,A

CDROM,C,A

CDROM,A,C

D,A,SCSI

E,A,SCSI

F,A,SCSI

SCSI,A,C

SCSI,C,A

C only

LS/ZIP,C

This parameter allows you to specify the system boot up search sequence. The hard disk ID are listed below:

C: Primary master

D: Primary slave

E: Secondary master

F: Secondary slave

LS: LS120

Zip: IOMEGA ZIP Drive

## BIOS Features Setup > Swap Floppy Drive

### Swap Floppy Drive

Enabled  
Disabled

This item allows you to swap floppy drives. For example, if you have two floppy drives (A and B), you can assign the first drive as drive B and the second drive as drive A or vice-versa.

## BIOS Features Setup > Boot Up Floppy Seek

### Boot Up Floppy Seek

Enable  
Disabled

Setting this item to force the system to seek the status in detail and detects any errors in both floppy drives during POST.

## BIOS Features Setup > Boot Up NumLock Status

### Boot Up NumLock Status

On  
Off

Setting this parameter to On enables the numeric function of the numeric keypad. Set this parameter to Off to disregard the function. Disabling the numeric function allows you to use the numeric keypad for cursor control.

### BIOS Features Setup > Memory Parity/ECC Check

**Memory Parity/ECC  
Check**

Disable

Enable

Set this option enable if the memory installed on the motherboard support Parity/ECC check. The default setting is **Disable**.

### BIOS Features Setup > Typematic Rate Setting

**Typematic Rate  
Setting**

Disable

Enable

Enable this item to force keyboard to repeat rapidly.



**BIOS Features Setup > Typematic Rate (Chars/Sec)****Typematic Rate**

6  
8  
10  
12  
15  
20  
24  
30

This item allows you to control the speed of repeated keystrokes. The default is 30 characters/sec.

**BIOS Features Setup > Typematic Delay (Msec)****Typematic Delay**

250  
500  
750  
1000

This parameter allows you to control the delay time between the first and the second keystroke (where the repeated keystrokes begin). The typematic delay settings are 250, 500, 750, and 1000 msec.

## BIOS Features Setup > Security Option

### Security Option

Setup  
System

The **System** option limits access to both the System boot and BIOS setup. A prompt asking you to enter your password appears on the screen every time you boot the system. The **Setup** option limits access only to BIOS setup. To disable the security option, select Password Setting from the main menu, don't type anything and just press <Enter>.

## BIOS Features Setup > PCI/VGA Palette Snoop

### PCI/VGA Palette Snoop

Enabled  
Disabled

Enabling this item informs the PCI VGA card to keep silent (and to prevent conflict) when palette register is updated (i.e., accepts data without responding any communication signals). This is useful only when two display cards use the same palette address and plugged in the PCI bus at the same time (such as MPEQ or Video capture). In such case, PCI VGA is silent while MPEQ/Video capture is set to function normally.

### BIOS Features Setup > OS Select for DRAM > 64MB

**OS Select for DRAM  
> 64MB**

OS/2

Non-OS/2

Set to OS/2 if your system is utilizing an OS/2 operating system and has a memory size of more than 64 MB.

### BIOS Features Setup > Show Logo On Screen

**Show Logo On  
Screen**

Enabled

Disabled

This item lets you show or hide AOpen logo on the [POST](#) screen.

### BIOS Features Setup > Video BIOS Shadow

**Video BIOS Shadow**

Enabled

Disabled

VGA BIOS Shadowing means to copy video display card BIOS into the DRAM area. This enhances system performance because DRAM access time is faster than ROM.

BIOS Features Setup > C800-CBFF Shadow

BIOS Features Setup > CC00-CFFF Shadow

BIOS Features Setup > D000-D3FF Shadow

BIOS Features Setup > D400-D7FF Shadow

BIOS Features Setup > D800-DBFF Shadow

BIOS Features Setup > DC00-DFFF Shadow

**C800-CBFF**  
**Shadow**

Enabled

Disabled

These six items are for shadowing ROM code on other expansion cards. Before you set these parameters, you need to know the specific addresses of that ROM code. If you do not know this information, enable all the ROM shadow settings.



**Note:** *The F000 and E000 segments are always shadowed because BIOS code occupies these areas.*

## Chipset Features Setup

The "Chipset Features Setup" includes settings for the chipset dependent features. These features are related to system performance.

```
ROM PCI/ISA BIOS (2A6LJAB9)
CHIPSET FEATURES SETUP
AWARD SOFTWARE, INC.

Bank 0/1 DRAM Timing : SDRAM 10ns
Bank 2/3 DRAM Timing : SDRAM 10ns
Bank 4/5 DRAM Timing : SDRAM 10ns
SDRAM CAS Latency   : 3
DRAM Clock          : CPU CLK
Memory Hole At 15M-16M : Disabled
Fast R-W Turn Around : Disabled
System BIOS Cacheable : Disabled
Video RAM Cacheable  : Disabled
AGP Mode             : 1x
AGP Aperture Size    : 128M
CPU Micro Codes      : Disabled

***** Jumperless Setup *****
Clock Spread Spectrum : Off
CPU Speed Detected    : 0 MHz
CPU Clock Frequency   : 124.0 MHz
CPU Clock Ratio       : 2.0
Setup CPU Speed       : 248.0 MHz
```

 **Warning:** Make sure you fully understand the items contained in this menu before you try to change anything. You may change the parameter settings to improve system performance. However, it may cause your system to be unstable if the setting is not correct for your system configuration.

Chipset Features Setup > Bank 0/1 DRAM Timing

Chipset Features Setup > Bank 2/3 DRAM Timing

Chipset Features Setup > Bank 4/5 DRAM Timing

**Bank 0/1 DRAM  
Timing**

SDRAM 10ns

SDRAM 8ns

Normal

Medium

Fast

Turbo

Change this item to control the DRAM timing.

The default value is “**SDRAM 10ns**”. Do not change the default value without understanding engineering knowledge.

Chipset Features Setup > SDRAM CAS Latency

**SDRAM CAS Latency**

2

3

This [SDRAM](#) timing is calculated by clocks. Adjust its value affects SDRAM performance, the default setting is 2 clocks.

If your system has unstable problem, change 2T to 3T.

## Chipset Features Setup > DRAM Clock

### **DRAM Clock**

CPU CLK,  
CPU CLK -33M,  
CPU CLK +33M

The DRAM Clock can be PCI clock x2, x3 or x4 depends on [JP29/JP23 FSB/PCI clock ratio](#). To be easily understood by users who do not overclock, it is displayed here as CPU CLK -33M, CPU CLK and CPU CLK +33M. Actually, it is CPU -PCI CLK, CPU CLK and CPU +PCI CLK.

### **PCI Clock = CPU FSB Clock / Clock Ratio**

<b>JP29/JP23 Clock Ratio</b>	<b>CPU FSB Clock</b>	<b>PCI</b>	<b>BIOS Setting</b>	<b>DRAM Clock</b>
2X	66	33	CPU, CPU+PCI	66, 100
3X	100	33	CPU-PCI, CPU, CPU+PCI	66, 100, 133
3X, overclocking	112	37.3	CPU-PCI, CPU, CPU+PCI	74.6, 112, 149.3
4X	133	33	CPU-PCI, CPU	100, 133
4X, overclocking	155	38.75	CPU-PCI, CPU	116.25, 155

### Chipset Features Setup > Memory Hole At 15M-16M

**Memory Hole At  
15M-16M**

Enabled  
Disabled

This option lets you reserve system memory area for special ISA cards. The chipset accesses code/data of these areas from the ISA bus directly. Normally, these areas are reserved for memory mapped I/O card.

### Chipset Features Setup > Fast R-W Turn Around

**Fast R-W Turn  
Around**

Enabled  
Disabled

Setting this item to synchronize CPU and DRAM timing. The default value is **Enable**.

### Chipset Features Setup > System BIOS Cacheable

**System BIOS  
Cacheable**

Enabled  
Disabled

Setting it to Enabled allows the system BIOS data at F0000h-FFFFFh (in main memory, 64K in all) to be cacheable for a better system performance.

However, if any program writes to this memory range, a system error may result.



### Chipset Features Setup > Video RAM Cacheable

**Video RAM Cacheable**

Enabled  
Disabled

This item lets you cache Video RAM A000 and B000.

### Chipset Features Setup > AGP Mode

**AGP Mode**

1X, 2X, 4X

This item allows you to adjust your AGP graphic card speed.

### Chipset Features Setup > AGP Aperture Size

**AGP Aperture Size**

4, 8, 16, 32, 64, 128M

This item lets you determine the effective size of the [AGP](#) Graphic Aperture.

## Chipset Features Setup > CPU Micro Codes

### CPU Micro Codes

Enabled  
Disabled

The micro codes are used to fix bugs of CPU, we strongly recommend to enable this item for system reliability reason. However, this microcode may slightly reduce CPU performance. We provide this option for your convenience if you like to test it.

## Chipset Features Setup > Clock Spread Spectrum

### Clock Spread Spectrum

On  
Off

This item is used to set clock spread spectrum for EMI testing. Normally, you don't need to change the default setting.

## Chipset Features Setup > CPU Speed Detected

### CPU Speed Detected

The actual CPU speed is automatically detected and shown here. It may be different with [Setup CPU Speed](#) because in some CPUs, the [CPU Clock Ratio](#) may be locked by CPU manufacturer.

## Chipset Features Setup > CPU Clock Frequency

### CPU Clock Frequency

66.8, 75, 83.3, 100, 105, 110, 112, 115, 120, 124, 133, 140, and 150 MHz.

This item lets you set external clock (FSB clock). The correct setting may vary because of different CPU products, refer to your CPU specification for more details.

## Chipset Features Setup > CPU Clock Ratio

### CPU Clock Ratio

1.5, 2.0, 2.5, 3.0, 3.5, 4.0, 4.5, 5.0, 5.5, 6.0, 6.5, 7.0, 7.5, 8.0

Intel Pentium II is designed to have different Internal (Core) and External (Bus) frequency. This item lets you select the ratio of Core/Bus frequency. The default value is 3.5x.

## Chipset Features Setup > Setup CPU Speed

### Setup CPU Speed

The CPU Speed is derived from the product of "CPU Clock Frequency" and "CPU Clock Ratio".

**Core Frequency = CPU FSB Clock \* CPU Ratio**

## Power Management Setup

The Power Management Setup screen enables you to control the motherboard green features. See the following screen.

```

ROM PCI/ISA BIOS (2A6LJAB9)
POWER MANAGEMENT SETUP
AWARD SOFTWARE, INC.
  
```

ACPI function	: Enabled	Primary INTR	: ON
Power Management	: User Define	IRQ3 (COM 2)	: Disabled
PM Control by APM	: No	IRQ4 (COM 1)	: Disabled
Video Off Method	: Blank Screen	IRQ5 (LPT 2)	: Disabled
ACPI Suspend Type	: S1(POS)	IRQ6 (Floppy Disk)	: Disabled
Standby Mode	: Disabled	IRQ7 (LPT 1)	: Disabled
Suspend Mode	: Disabled	IRQ8 (RTC Alarm)	: Disabled
HDD Power Down	: Disabled	IRQ9 (IRQ2 Redir)	: Disabled
Soft-off by PWRBTN	: Delay 4 Sec	IRQ10 (Reserved)	: Disabled
Wake On PCI Card	: Disabled	IRQ11 (Reserved)	: Disabled
Wake On Modem	: Disabled	IRQ12 (PS/2 Mouse)	: Disabled
Wake On LAN	: Disabled	IRQ13 (Coprocessor)	: Disabled
Wake On RTC timer	: Enabled	IRQ14 (Hard Disk)	: Disabled
Date (of Month)	: 0	IRQ15 (Reserved)	: Disabled
Timer (hh:mm:ss)	: 0: 0: 0		
VGA	: OFF	ESC : Quit	↑↓+* : Select Item
LPT & COM	: NONE	F1 : Help	PU/PD/+/- : Modify
HDD & FDD	: OFF	F5 : Old Values	F9 : Language
PCI Master	: OFF	F6 : Load Setup Defaults	
AC PWR Auto Recovery	: Former Status	F7 : Load Turbo Defaults	

## Power Management Setup > ACPI Function

### ACPI Function

Enabled  
Disabled

If your OS is ACPI enabled you have to set this item to Enabled, or there may be unexpected errors. If your OS is APM mode, you can remain the Disabled setting.

## Power Management Setup > Power Management

### Power Management

Max Saving  
Mn Saving  
User Define  
Disabled

This function allows you to set the default parameters of power-saving modes. Set to **Disable** to turn off power management function. Set to User Define to choose your own parameters.

Mode	Doze	Standby	Suspend	HDD Power Down
Min Saving	1 hour	1 hour	1 hour	15 min
Max Saving	1 min	1 min	1 min	1 min

### Power Management Setup > PM Controlled by APM

**PM Controlled by  
APM**Yes  
No

If "Max Saving" is selected, you can turn on this item, transfer power management control to APM (Advanced Power Management) and enhance power saving function. For example, stop CPU internal clock.

### Power Management Setup > Video Off Method

**Video Off Method**V/H SYNC + Blank  
DPMS Support  
Blank Screen

This determines the way that monitor is off. Blank Screen writes blanks to video buffer. V/H SYNC+Blank allows BIOS to control VSYNC and HSYNC signals. This function applies only for DPMS (Display Power Management Standard) monitor. The DPMS mode uses DPMS function provided by VGA card.

### Power Management Setup > ACPI Suspend Type

**ACPI Suspend Type**S1 (POS)  
S3 (STR)

This function allows you to select suspend types. S1 is Power On Suspend and S3 is Suspend to RAM.

## Power Management Setup > Standby Mode

### **Standby Mode**

Disabled, , 10 Sec,  
20 Sec, 30 Sec,  
40 Sec. 1 Min, 2 Min,  
4 Min, 6 Min, 8 Min,  
10 Min, 20 Min, 30 Min,  
40 Min, 1 Hour

This item lets you set the period of time after which the system enters into Standby mode. The system activity (or event) is detected by monitoring the IRQ signals or other events (such as I/O).

## Power Management Setup > Suspend Mode

### **Suspend Mode**

Disabled, , 10 Sec,  
20 Sec, 30 Sec,  
40 Sec. 1 Min, 2 Min,  
4 Min, 6 Min, 8 Min,  
10 Min, 20 Min, 30 Min,  
40 Min, 1 Hour

This item lets you set the period of time after which the system enters into Suspend mode.

## Power Management Setup > HDD Power Down

### HDD Power Down

Disabled, 1 Min,.....

15 Min

This option lets you specify the IDE HDD idle time before the device enters the power down state. This item is independent from the power states previously described in this section (Doze, Standby and Suspend).

## Power Management Setup > Soft-Off by PWRBTN

### Soft-Off by PWRBTN

Delay 4 sec.

Instant-Off

This is a specification of ACPI and supported by hardware. When **Delay 4 sec.** is selected, the soft power switch on the front panel can be used to control power On, Suspend and Off. If the switch is pressed less than 4 sec during power On, the system will go into Suspend mode. If the switch is pressed longer than 4 sec, the system will be turned Off. The default setting is **Instant-Off**, soft power switch is only used to control On and Off, there is no need to press 4 sec, and there is no Suspend.



### Power Management Setup > Wake On PCI Card

**Wake On PCI Card**

Enable  
Disable

This is a function of PCI specification 2.2. PCI bus supports standby current to PCI card and PCI card can wakeup system if it detects certain activity.

### Power Management Setup > Wake On Modem

**Wake On Resume**

Enabled  
Disabled

This option lets you specify enable or disable Modem Wake Up function.

### Power Management Setup > Wake On LAN

**Wake On LAN**

Enabled  
Disabled

This option lets you specify enable or disable LAN Wake Up function.

## Power Management Setup > Wake On RTC Timer

### Wake On RTC Timer

Enabled  
Disabled

The Wake Up Timer is more like an alarm, which wakes up and powers on your system at a pre-defined time for a specific application. It can be set to wake up everyday or on specific date within a month. The date/time is accurate to within a second. This option lets you enable or disable the RTC Wake Up function.

## Power Management Setup > Date (of Month)

### Date (of Month)

0 - 31

To specify the date to wake up your system. You must enable the "Wake On RTC Timer" first to set this item.

## Power Management Setup > Timer (hh:mm:ss)

### Timer (hh:mm:ss)

00: 00: 00 -  
23: 59: 59

To specify the time to wake up your system. You must enable the "Wake On RTC Timer" first to set this item.

**Power Management Setup > VGA****Power Management Setup > LPT & COM****Power Management Setup > HDD & FDD****Power Management Setup > PCI Master****VGA**

ON  
OFF

To enable or disable the detection of VGA, LPT, COM, HDD, and PCI activities for power down state transition.

**Power Management Setup > AC PWR Auto Recovery****AC PWR Auto  
Recovery**

Former Status  
On  
Off

A traditional ATX system should remain at power off stage when AC power resumes from power failure. This design is inconvenient for a network server or workstation, without an UPS, that needs to keep power-on. This item is used to solve this problem. Selecting On enabling system to automatically power-on after AC power resumes; in the other hand, the system will remain power-off if you select Off. If Former Status option is selected, the system will power-on or power-off based on the original state.

**Power Management Setup > Primary INTR****Primary INTR**

ON  
OFF

This item is used to enable or disable the detection of IRQ3-15 or NMI interrupt events for power down state transition. Normally, this is applied to network card.

- Power Management Setup > IRQ3 (COM 2)
- Power Management Setup > IRQ4 (COM 1)
- Power Management Setup > IRQ5 (LPT 2)
- Power Management Setup > IRQ6 (Floppy Disk)
- Power Management Setup > IRQ7 (LPT 1)
- Power Management Setup > IRQ8 (RTC Alarm)
- Power Management Setup > IRQ9 (IRQ 2 Redir)
- Power Management Setup > IRQ10 (Reserved)
- Power Management Setup > IRQ11 (Reserved)
- Power Management Setup > IRQ12 (PS/2 Mouse)
- Power Management Setup > IRQ13 (Coprocessor)
- Power Management Setup > IRQ14 (Hard Disk)
- Power Management Setup > IRQ15 (Reserved )

**IRQ 3 (COM2)**

Primary  
Secondary  
Disabled

These items are used to enable or disable the detection of IRQ3-15 interrupt events for power down state transition.

## PNP/PCI Configuration Setup

The [PNP](#)/PCI Configuration Setup allows you to configure the ISA and PCI devices installed in your system. The following screen appears if you select the option "PNP/PCI Configuration " from the main menu.

```

ROM PCI/ISA BIOS (2A6LJAB9)
PNP/PCI CONFIGURATION
AWARD SOFTWARE, INC.

PNP OS Installed      : No
Resources Controlled By : Manual

IRQ-3 assigned to : PCI/ISA PnP
IRQ-4 assigned to : PCI/ISA PnP
IRQ-5 assigned to : PCI/ISA PnP
IRQ-7 assigned to : PCI/ISA PnP
IRQ-9 assigned to : PCI/ISA PnP
IRQ-10 assigned to : PCI/ISA PnP
IRQ-11 assigned to : PCI/ISA PnP
IRQ-12 assigned to : PCI/ISA PnP
IRQ-14 assigned to : PCI/ISA PnP
IRQ-15 assigned to : PCI/ISA PnP
DMA-0 assigned to : PCI/ISA PnP
DMA-1 assigned to : PCI/ISA PnP
DMA-3 assigned to : PCI/ISA PnP
DMA-5 assigned to : PCI/ISA PnP
DMA-6 assigned to : PCI/ISA PnP
DMA-7 assigned to : PCI/ISA PnP

CPU to PCI Write Buffer: Disabled
PCI Dynamic Bursting  : Disabled
PCI Master 0 WS Write : Enabled
PCI Delay Transaction : Disabled
PCI#2 Access #1 Retry : Disabled
AGP Master 1 WS Write : Disabled
AGP Master 1 WS Read  : Disabled
Assign IRQ For USB    : Disabled
Assign IRQ For VGA    : Disabled
MODEM Use IRQ         : NA
Slot 1 Use IRQ No.    : Auto
Slot 2 Use IRQ No.    : Auto
Slot 3 Use IRQ No.    : Auto

ESC : Quit      ↑↓←→ : Select Item
F1  : Help      PU/PD/+/- : Modify
F5  : Old Values F9   : Language
F6  : Load Setup Defaults
F7  : Load Turbo Defaults
  
```

### PNP/PCI Configuration > PNP OS Installed

**PNP OS Installed**

Yes  
No

Normally, the PnP resources are allocated by BIOS during [POST](#) (Power-On Self Test). If you are using a [PnP](#) operating system (such as Windows 95), set this item to **Yes** to inform BIOS to configure only the resources needed for booting (VGA/IDE or SCSI). The rest of system resources will be allocated by PnP operating system.

### PNP/PCI Configuration > Resources Controlled By

**Resources Controlled  
By**

Auto  
Manual

Setting this option to Manual allows you to individually assign the IRQs and DMAs to the ISA and PCI devices. Set this to **Auto** to enable the auto-configuration function.

PNP/PCI Configuration > IRQ3 assigned to  
PNP/PCI Configuration > IRQ4 assigned to  
PNP/PCI Configuration > IRQ5 assigned to  
PNP/PCI Configuration > IRQ7 assigned to  
PNP/PCI Configuration > IRQ9 assigned to  
PNP/PCI Configuration > IRQ10 assigned to  
PNP/PCI Configuration > IRQ11 assigned to  
PNP/PCI Configuration > IRQ12 assigned to  
PNP/PCI Configuration > IRQ14 assigned to  
PNP/PCI Configuration > IRQ15 assigned to

**IRQ 3 assigned to**

Legacy ISA  
PCI/ISA PnP

If your ISA card is not PnP compatible and requires a special IRQ to support its function, set the selected IRQ to **Legacy ISA**. This setting informs the PnP BIOS to reserve the selected IRQ for the installed legacy ISA card. The default is **PCI/ISA PnP**. Take note that PCI cards are always PnP compatible (except old PCI IDE card).



PNP/PCI Configuration > DMA 0 assigned to

PNP/PCI Configuration > DMA 1 assigned to

PNP/PCI Configuration > DMA 3 assigned to

PNP/PCI Configuration > DMA 5 assigned to

PNP/PCI Configuration > DMA 6 assigned to

PNP/PCI Configuration > DMA 7 assigned to

**DMA 0  
assigned to**

Legacy ISA  
PCI/ISA PnP

If your ISA card is not PnP compatible and requires a special DMA channel to support its function, set the selected DMA channel to **Legacy ISA**. This setting informs the PnP BIOS to reserve the selected DMA channel for the installed legacy ISA card. The default is **PCI/ISA PnP**. Take note that PCI card does not require DMA channel.

PNP/PCI Configuration > CPU to PCI Write Buffer

**CPU to PCI Write  
Buffer**

Enable  
Disable

This item is used to enable or disable CPU to PCI write buffer.

### PNP/PCI Configuration > PCI Dynamic Bursting

**PCI Dynamic Bursting**

Enable

Disable

This item is used to enable or disable PCI dynamic bursting.

### PNP/PCI Configuration > PCI Master 0 WS Write

**PCI Master 0 WS  
Write**

Enable

Disable

This item is used to control the PCI master write cycle. If enabled, there is no wait state. If disabled, there will be one wait state for PCI master write.

### PNP/PCI Configuration > PCI Delay Transaction

**PCI Delay Transaction**

Enable

Disable

This item lets you control the Delayed Transaction function of the VIA 586A chipset (Intel PCI to ISA bridge). This function is used to meet latency of PCI cycles to or from ISA bus. Try to enable or disable it, if you have ISA card compatibility problem.

### PNP/PCI Configuration > PCI#2 Access #1 Retry

**PCI#2 Access #1  
Retry**

Enable  
Disable

This item is used to enable or disable AGP master retry disconnect. If enabled, AGP master will be disconnected if max retries are attempted without success. PCI#2 means AGP.

### PNP/PCI Configuration > AGP Master 1 WS Write

**AGP Master 1 WS  
Write**

Enable  
Disable

This item is used to enable or disable AGP master 1 wait state write.

### PNP/PCI Configuration > AGP Master 1 WS Read

**AGP Master 1 WS  
Read**

Enable  
Disable

This item is used to enable or disable AGP master 1 wait state read.

### PNP/PCI Configuration > Assign IRQ for USB

**Assign IRQ for USB**

Enabled  
Disabled

This item lets you set an IRQ for USB.

### PNP/PCI Configuration > Assign IRQ for VGA

**Assign IRQ for VGA**

Enabled  
Disabled

This item lets you set an IRQ for VGA.

### PNP/PCI Configuration > Modem Use IRQ

**Modem Use IRQ**

3, 4, 5, 7, 9, 10, 11, N/A

This item lets you set an IRQ for the modem.

**PNP/PCI Configuration > Slot 1 IRQ No.**

**PNP/PCI Configuration > Slot 2 IRQ No.**

**PNP/PCI Configuration > Slot 3 IRQ No.**

**Slot1 IRQ No.**

3, 4, 5, 6, 7, 9, 10, 11,  
12, 14, 15, Auto

This item is reserved for engineering purpose to let you assign an IRQ manually to the add-on card on each PCI slot. If you select Auto, system will automatically assign an available value to the device.

It is suggested to use default setting, which is Auto, in order to comply with PnP specification completely.

## Load Setup Defaults

The "Load Setup Defaults" option loads optimized settings for optimum system performance. Optimal settings are relatively safer than the Turbo settings. **All the product verification, compatibility/reliability test report and manufacture quality control are based on "Load Setup Defaults"**. We recommend to use this settings for normal operation. "Load Setup Defaults" is not the slowest setting for this motherboard. If you need to verify an unstable problem, you may manually set the parameter in the "[BIOS Features Setup](#)" and "[Chipset Features Setup](#)" to get slowest and safer setting.

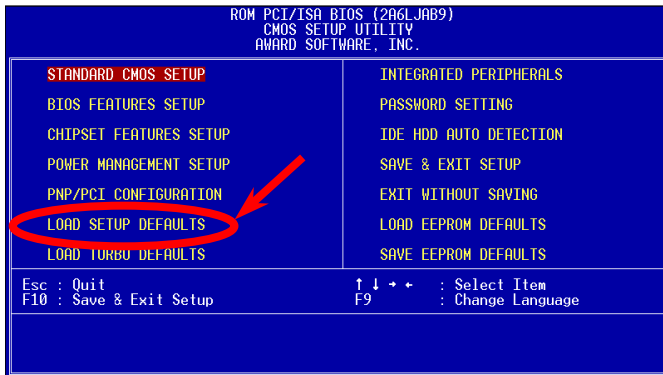

## Load Turbo Defaults

The "Load Turbo Defaults" option gives better performance than "Load Setup Defaults". It is provided for the convenience of power user who wants to push the motherboard to get better performance. Turbo setting does not go through all the detail reliability and compatibility test, it is tested only with limited configuration and loading (for example, a system that contains only a VGA card and two DIMMs). **Use Turbo setting only when you fully understand the items in Chipset Setup menu.** The performance improvement of Turbo setting is normally around 3% to 5%, depending on the chipset and the application.

## Integrated Peripherals

The following screen appears if you select the option "Integrated Peripherals" from the main menu. This option allows you to configure the I/O features.

```

ROM PCI/ISA BIOS (2A6LJAB9)
INTEGRATED PERIPHERALS
AWARD SOFTWARE, INC.

OnChip Primary IDE : Enabled
OnChip Secondary IDE : Enabled
IDE Prefetch Mode : Enabled
IDE HDD Block Mode : Enabled
Primary Master PIO : Auto
Primary Slave PIO : Auto
Secondary Master PIO : Auto
Secondary Slave PIO : Auto
Primary Master UDMA : Disabled
Primary Slave UDMA : Disabled
Secondary Master UDMA : Disabled
Secondary Slave UDMA : Disabled
Init Display First : PCI Slot

OnChip Sound : Enabled
OnChip Legacy Audio : Enabled
Sound I/O Base Address: 220H
Sound IRQ Select : IRQ 5
Sound DMA Select : DMA 0
MPU-401 I/O Address : 300-303H

Onboard FDD Controller: Disabled
Onboard Serial Port 1 : Disabled
Onboard Serial Port 2 : 3F8/IRQ4
UART 2 Mode : HPSIR
IR Function Duplex : Full
RxD,TxD Active : Hi,Hi
Onboard Parallel Port : 3BC/IRQ7
Onboard Parallel Mode : ECP/EPP
ECP Mode Use DMA : 1
Parallel Port EPP Type: EPP1.9
OnChip USB : Enabled
USB Keyboard Support : Disabled

ESC : Quit          ↑↓←→ : Select Item
F1 : Help          PU/PD/+/- : Modify
F5 : Old Values   F9 : Language
F6 : Load Setup Defaults
F7 : Load Turbo Defaults
  
```



### Integrated Peripherals > OnChip Primary IDE

### Integrated Peripherals > OnChip Secondary IDE

**OnChip Primary IDE**

Enabled  
Disabled

This parameter lets you enable or disable the IDE device connected to the primary IDE connector.

### Integrated Peripherals > IDE Prefetch Mode

**IDE Prefetch Mode**

Enabled  
Disabled

This item is used to enable and disable IDE prefetch mode.

### Integrated Peripherals > IDE HDD Block Mode

**IDE HDD Block Mode**

Enabled  
Disabled

This feature enhances disk performance by allowing multi-sector data transfers and eliminates the interrupt handling time for each sector. Most IDE drives, except with old designs, can support this feature.

[Integrated Peripherals > Primary Master PIO](#)

[Integrated Peripherals > Primary Slave PIO](#)

[Integrated Peripherals > Secondary Master PIO](#)

[Integrated Peripherals > Secondary Slave PIO](#)

**Primary Master PIO**

Auto

Mode 1

Mode 2

Mode 3

Mode 4

Setting this item to **Auto** activates the HDD speed auto-detect function. The PIO mode specifies the data transfer rate of HDD. For example: mode 0 data transfer rate is 3.3MB/s, mode 1 is 5.2MB/s, mode 2 is 8.3MB/s, mode 3 is 11.1MB/s and mode 4 is 16.6MB/s. If your hard disk performance becomes unstable, you may manually try the slower mode.

**Integrated Peripherals > Primary Master UDMA****Integrated Peripherals > Primary Slave UDMA****Integrated Peripherals > Secondary Master UDMA****Integrated Peripherals > Secondary Slave UDMA****Primary Master UDMA**

Auto  
Disabled

This item allows you to set the [ATA/66](#) mode supported by the hard disk drive connected to your primary IDE connector.

**Integrated Peripherals > Init Display First****Init Display First**

PCI Slot  
AGP

If you installed a PCI VGA card and an [AGP](#) card at the same time, this item lets you decide which one is the initial display card.

**Integrated Peripherals > OnChip Sound****OnChip Sound**

Enable  
Disable

This item is used to enable or disable the onboard audio.

### Integrated Peripherals > OnChip Legacy Audio

**OnChip Legacy Audio**

Enable

Disable

This motherboard has a Sound Blaster Pro compatible onchip audio. This item should be set to Enabled under DOS mode.

### Integrated Peripherals > Sound I/O Base Address

**Sound I/O Base Address**220H, 240H, 260H,  
280H

This item is used to select Sound Blaster compatible I/O base address for the onboard audio.

### Integrated Peripherals > Sound IRQ Select

**Sound IRQ Select**IRQ5, IRQ7, IRQ9,  
IRQ10

This item is used to select Sound Blaster compatible IRQ for the onboard audio.

### Integrated Peripherals > Sound DMA Select

**Sound DMA Select**

DMA0, DMA1,  
DMA2, DMA3

This item is used to select Sound Blaster compatible DMA for the onboard audio.

### Integrated Peripherals > MPU-401 I/O Address

**MPU-401 I/O Address**

300-303H  
310-313H  
320-323H  
330-333H

This item is used to select I/O base address for the MIDI port.

### Integrated Peripherals > Onboard FDD Controller

**Onboard FDD  
Controller**

Enabled  
Disabled

Setting this parameter to **Enabled** allows you to connect your floppy disk drives to the onboard floppy disk connector instead of a separate controller card. Change the setting to Disabled if you want to use a separate controller card.

## Integrated Peripherals > Onboard Serial Port 1

## Integrated Peripherals > Onboard Serial Port 2

### Onboard Serial Port 1

Auto

3F8/IRQ4

2F8/IRQ3

3E8/IRQ4

2E8/IRQ3

Disabled

This item allows you to assign address and interrupt for the board serial port. Default is **Auto**.

**Note:** *If you are using network card, make sure that the IRQ do not conflict.*

## Integrated Peripherals > UART 2 Mode

### UART 2 Mode

Standard  
HPSIR  
ASKIR

This item is configurable only if the "[Onboard Serial Port 2](#)" is enabled. This allows you to specify the mode of serial port2. The available mode selections are:

### **Standard**

Sets serial port 2 to operate in normal mode. This is the default setting.

### **HPSIR**

This setting allows infrared serial communication at a maximum baud rate of 115K baud.

### **ASKIR**

This setting allows infrared serial communication at a maximum baud rate of 19.2K baud.

## Integrated Peripherals > IR Function Duplex

### IR Function Duplex

Full  
Half

This item is used to select Full Duplex or Half Duplex of IR function. Normally, Full Duplex is faster, because it transmits data bi-direction at the same time.

### Integrated Peripherals > RxD, TxD Active

**RxD, TxD Active**

Hi, Hi  
Hi, Lo,  
Lo, Hi  
Lo, Lo

This item is used to select RxD (Receive Data) and TxD (Transmit Data) mode for UART 2, when used for IR function. Please refer to the documentation that comes with your IR device.

### Integrated Peripherals > Onboard Parallel Port

**Onboard Parallel Port**

3BC/IRQ7  
378/IRQ7  
278/IRQ5  
Disabled

This item controls the onboard parallel port address and interrupt.



**Note:** *If you are using an I/O card with a parallel port, make sure that the addresses and IRQ do not conflict.*



## Integrated Peripherals > Onboard Parallel Mode

**Onboard Parallel  
Mode**

Normal

SPP

ECP

EPP

ECP/EPP

This item lets you set the parallel port mode. The mode options are SPP (Standard and Bi-direction Parallel Port), EPP (Enhanced Parallel Port) and ECP (Extended Parallel Port).

**SPP (Standard and Bidirection Parallel Port)**

SPP is the IBM AT and PS/2 compatible mode.

**EPP (Enhanced Parallel Port)**

EPP enhances the parallel port throughput by directly writing/reading data to/from parallel port without latch.

**ECP (Extended Parallel Port)**

ECP supports DMA and RLE (Run Length Encoded) compression and decompression.

### Integrated Peripherals > ECP Mode Use DMA

**ECP Mode Use DMA**

3

1

This item lets you set the DMA channel of ECP mode.

### Integrated Peripherals > Parallel Port EPP Type

**Parallel Port EPP Type**

EPP1.7

EPP1.9

This item lets you select EPP mode protocol.

### Integrated Peripherals > OnChip USB

**OnChip USB**

Enabled

Disabled

This item is used to enable or disable [USB](#) controller.

## Integrated Peripherals > USB Keyboard Support

### USB Keyboard Support

Enabled  
Disabled

This item lets you enable or disable the [USB](#) keyboard driver within the onboard BIOS. The keyboard driver simulates legacy keyboard command and let you use USB keyboard during [POST](#) or after boot if you don't have USB driver in the operating system.



**Note:** You cannot use both USB driver and USB legacy keyboard at the same time. Disable "[USB Keyboard Support](#)" if you have USB driver in the operating system.

## Password Setting

Password prevents unauthorized use of your computer. If you set a password, the system prompts for the correct password before boot or access to Setup.

To set a password:

1. At the prompt, type your password. Your password can be up to 8 alphanumeric characters. When you type the characters, they appear as asterisks on the password screen box.
2. After typing the password, press.
3. At the next prompt, re-type your password and press again to confirm the new password. After the password entry, the screen automatically reverts to the main screen.

To disable the password, press when prompted to enter the password. The screen displays a message confirming that the password has been disabled.



This routine only detects one set of parameters for your IDE hard drive. Some IDE drives can use more than one set of parameters. If your hard disk is formatted using different parameters than those detected, you have to enter the parameters manually. If the parameters listed do not match the ones used to format the disk, the information on that disk will not be accessible. If the auto-detected parameters displayed do not match those that used for your drive, ignore them. Type **N** to reject the values and enter the correct ones manually from the Standard CMOS Setup screen.

## Save & Exit Setup

This function automatically saves all CMOS values before leaving Setup.

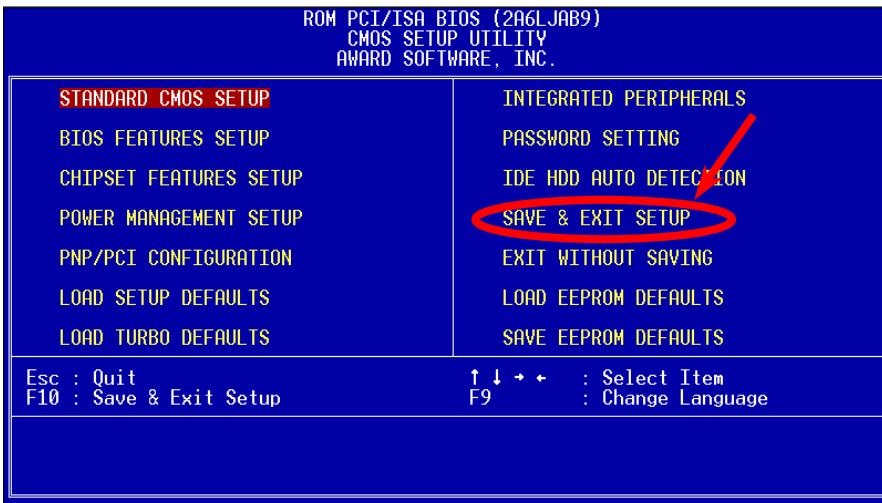

## **Load EEPROM Default**

Except "Load Setup Default" and "Load Turbo Default", you may also use "Save EEPROM Default " to save your own settings into [EEPROM](#), and reload by using this item.

## **Save EEPROM Default**

You may use this item to save your own settings into [EEPROM](#). Then, if the data in CMOS is lost or you forget the previous settings, you may use "Load EEPROM Default " to reload.

## **Exit without Saving**

Use this function to exit Setup without saving the CMOS value changes. Do not use this option if you want to save the new configuration.

## **NCR SCSI BIOS and Drivers**

Due to [Flash ROM](#) space limitation, some BIOS versions do not include NCR 53C810 SCSI BIOS (supports DOS, Windows 3.1 and OS/2) into the system BIOS. Many SCSI cards have its own SCSI BIOS on card, for better system performance, you may use the drivers that come with the NCR SCSI card or with your operating system. For details, refer to the installation manual of your NCR 53C810 SCSI card.



## BIOS Upgrade

AOpen Easy Flash is more user friendly than traditional flash method. The [BIOS](#) binary file and flash routine are combined together and you simply run a single file to complete the flash process.

1. Get new BIOS upgrade program from AOpen's web site. For example, MX34109.EXE. It is recommended to save it to a bootable DOS floppy diskette for error recovery.
2. Reboot the system to DOS mode without loading any memory handler (such as EMM386) or device driver. It needs around 520K free memory space.
3. Execute A:> MX34109

**DO NOT turn off the power during FLASH PROCESS.**

Del

4. Reboot system and press <Del> to [enter BIOS setup](#). Choose "[Load Setup Defaults](#)", then "[Save & Exit Setup](#)". Done!



**Warning:** The upgrade of new BIOS will permanently replace your original BIOS content after flashing. The original BIOS setting and Win95/Win98 PnP information will be refreshed and you probably need to re-configure your system.

# Overclocking

As a leading manufacturer in motherboard industry, AOpen always listens to what customers want and develop products to fit different user's requirements. Reliability, compatibility, leading technology and friendly features are our basic goals when designing motherboards. Other than above mentioned design criteria, there are power users who are always seeking to push the limitation of the system performance by overclocking which we call them "Overclocker".

This section is dedicated to Overclockers.

This high performance motherboard is designed for maximum **133MHz** CPU bus clock. But it comes with clock generator of **150MHz** when we design it to accommodate future CPU bus clock. Our lab test results shown that **150MHz** is achievable when proper setting and qualified components were presented.



**Warning:** *The design of this product follows CPU and chipset vendor's design guideline. Any attempts to push beyond product specification are not recommended and you are taking your own risk to damage your system or important data. Before doing overclocking, you must make sure your components are able to tolerate such abnormal setting, especially CPU, memory, hard disks, and AGP VGA cards.*



**Tip:** *Note that overclocking may also cause thermal problem. Please make sure that the cooling fan and the heatsink were adequate to dissipate excessive heat that's generated by overclocking the CPU.*

## ***VGA and HDD***

VGA and HDD are key components for overclocking, following list are what have been tested in our lab. Please note that AOpen can not guaranty they can be successful overclocked again.

**VGA:** <http://www.aopen.com.tw/tech/report/overclk/mb/vga-oc.htm>

**HDD:** <http://www.aopen.com.tw/tech/report/overclk/mb/hdd-oc.htm>

# Glossary

## AC97

Basically, AC97 specification separates sound/modem circuit to two parts, digital processor and a [CODEC](#) for analog I/O, they are linked by AC97 link bus. Since digital processor can be put into motherboard main chipset, the cost of sound/modem onboard solution can be reduced.

## ACPI (*Advanced Configuration & Power Interface*)

ACPI is the power management specification of PC97 (1997). It intends to save more power by taking full control of power management to operating system and bypass [BIOS](#). The chipset or super I/O chip needs to provide standard register interface to operating system (such as Windows 98). This is a bit similar as the [PnP](#) register interface. ACPI defines ATX momentary soft power switch to control the power state transition.

## AGP (*Accelerated Graphic Port*)

AGP is a bus interface targeted for high-performance 3D graphic. AGP supports only memory read/write operation and single-master single-slave one-to-one only. AGP uses both rising and falling edge of the 66MHz clock, for 2X AGP, the data transfer rate is  $66\text{MHz} \times 4\text{byte} \times 2 = 528\text{MB/s}$ . AGP is now moving to 4X mode,  $66\text{MHz} \times 4\text{byte} \times 4 = 1056\text{MB/s}$ . AOpen is the first company to

support 4X AGP motherboards by both AX6C (Intel 820) and MX64/AX64 (VIA 694x), started from Oct 1999.

### **AMR (Audio/Modem Riser)**

The [CODEC](#) circuit of AC97 sound/modem solution can be put on motherboard or put on a riser card (AMR card) that connects to motherboard through AMR connector.

### **AOpen Bonus Pack CD**

A disc bundled with AOpen motherboard product, there are motherboard drivers, Acrobat Reader for [PDF](#) online manual and other useful utilities.

### **APM**

Unlike [ACPI](#), BIOS controls most APM power management functions. AOpen Suspend to Hard Drive is a good example of APM power management.

### **ATA/66**

ATA/66 uses both rising edge and falling edge but doubles [UDMA/33](#) transfer rate. The data transfer rate is 4 times of the PIO mode 4 or DMA mode 2, 16.6MB/s x4 = 66MB/s. To use ATA/66, you need special ATA/66 IDE cable.

## **ATA/100**

ATA/100 is a new IDE specification under developing. ATA/100 uses both rising edge and falling edge as [ATA/66](#) but clock cycle time is reduced to 40ns. The data transfer rate is  $(1/40\text{ns}) \times 2 \text{ bytes} \times 2 = 100\text{MB/s}$ . To use ATA/100, you need special 80-wire IDE cable, the same as ATA/66.

## **BIOS (Basic Input/Output System)**

BIOS is a set of assembly routine/program that reside in [EPROM](#) or [Flash ROM](#). BIOS controls Input/output devices and other hardware devices of motherboard. In general, to provide hardware independent portability, operation system and drivers is required to access BIOS without directly access hardware devices.

## **Bus Master IDE (DMA mode)**

The traditional PIO (Programmable I/O) IDE requires the CPU to involve in all the activities of the IDE access including waiting for the mechanical events. To reduce the workload of the CPU, the bus master IDE device transfers data from/to memory without interrupting CPU, and releases CPU to operate concurrently while data is transferring between memory and IDE device. You need the bus master IDE driver and the bus master IDE HDD to support bus master IDE mode.

## **CODEC (Coding and Decoding)**

Normally, CODEC means a circuit that can do digital to analog conversion and also the analog to digital conversion. It is part of [AC97](#) sound/modem solution.

### ***DIMM (Dual In Line Memory Module)***

DIMM socket has total 168-pin and supports 64-bit data. It can be single or double side, the golden finger signals on each side of PCB are different, that is why it was called Dual In Line. Almost all DIMMs are made by [SDRAM](#), which operate at 3.3V. Note that some old DIMMs are made by FPM/[EDO](#) and only operate at 5V. Do not confuse them with SDRAM DIMM..

### ***ECC (Error Checking and Correction)***

The ECC mode needs 8 ECC bits for 64-bit data. Each time memory is accessed, ECC bits are updated and checked by a special algorithm. The ECC algorithm has the ability to detect double-bit error and automatically correct single-bit error while parity mode can only detect single-bit error.

### ***EDO (Extended Data Output) Memory***

The EDO DRAM technology is actually very similar to FPM (Fast Page Mode). Unlike traditional FPM that tri-states the memory output data to start the pre-charge activity, EDO DRAM holds the memory data valid until the next memory access cycle, that is similar to pipeline effect and reduces one clock state.

### ***EEPROM (Electronic Erasable Programmable ROM)***

Also known as E<sup>2</sup>PROM. Both EEPROM and [Flash ROM](#) can be re-programmed by electronic signals, but the interface technology is different. Size of EEPROM is much smaller than flash ROM, AOpen motherboard uses EEPROM for jumper-less and battery-less design.



## ***EPROM (Erasable Programmable ROM)***

Traditional motherboard stores BIOS code in EPROM. EPROM can only be erased by ultra-violet (UV) light. If BIOS has to be upgraded, you need to remove EPROM from motherboard, clear by UV light, re-program, and then insert back.

## ***FCC DoC (Declaration of Conformity)***

The DoC is component certification standard of FCC EMI regulations. This standard allows DIY component (such as motherboard) to apply DoC label separately without a shielding of housing.

## ***FC-PGA***

FC means Flip Chip, FC-PGA is a new package of Intel for Pentium III CPU. It can plug into SKT370 socket, but require motherboard to add some signals on socket 370. That is, the motherboard needs to be redesigned. Intel is going to ship FC-PGA 370 CPU and phase out slot1 CPU.

## ***Flash ROM***

Flash ROM can be re-programmed by electronic signals. It is easier for BIOS to upgrade by a flash utility, but it is also easier to be infected by virus. Because of increase of new functions, BIOS size is increased from 64KB to 256KB (2M bit). AOpen AX5T is the first board to implement 256KB (2Mbit) Flash ROM. Now flash ROM size is moving to 4M bit on AX6C (Intel 820) and MX3W (Intel 810) motherboard.

## ***FSB (Front Side Bus) Clock***

FSB Clock means CPU external bus clock.

CPU internal clock = CPU FSB Clock x CPU Clock Ratio

## ***I2C Bus***

See [SMBus](#).

## ***P1394***

P1394 (IEEE 1394) is a standard of high-speed serial peripheral bus. Unlike low or medium speed [USB](#), P1394 supports 50 to 1000Mbit/s and can be used for video camera, disk and LAN.

## ***Parity Bit***

The parity mode uses 1 parity bit for each byte, normally it is even parity mode, that is, each time the memory data is updated, parity bit will be adjusted to have even count "1" for each byte. When next time, if memory is read with odd number of "1", the parity error is occurred and this is called single bit error detection.

## ***PBSRAM (Pipelined Burst SRAM)***

For Socket 7 CPU, one burst data read requires four QWord (Quad-word, 4x16 = 64 bits). PBSRAM only needs one address decoding time and automatically sends the remaining QWords to CPU according to a predefined sequence. Normally, it is 3-1-1-1, total 6 clocks, which is faster than

asynchronous SRAM. PBSRAM is often used on L2 (level 2) cache of Socket 7 CPU. Slot 1 and Socket 370 CPU do not need PBSRAM.

### ***PC100 DIMM***

[SDRAM](#) DIMM that supports 100MHz CPU [FSB](#) bus clock.

### ***PC133 DIMM***

[SDRAM](#) DIMM that supports 133MHz CPU [FSB](#) bus clock.

### ***PDF Format***

A file format for electronic document, PDF format is independent from platform, you can read PDF file under Windows, Unix, Linux, Mac ... with different PDF reader. You can also read PDF file by web browser such as IE and Netscape, note that you need to install PDF plug-in first (Included in Acrobat Reader).

### ***PnP (Plug and Play)***

The PnP specification suggests a standard register interface for both BIOS and operating system (such as Windows 95). These registers are used by BIOS and operating system to configure system resource and prevent any conflicts. The IRQ/DMA/Memory will be automatically allocated by PnP BIOS or operating system. Currently, almost all the PCI cards and most ISA cards are already PnP compliant.

## ***POST (Power-On Self Test)***

The BIOS self test procedure after power-on, sometimes, it is the first or the second screen shown on your monitor during system boot.

## ***RDRAM (Rambus DRAM)***

Rambus is a memory technology that uses large burst mode data transfer. Theoretically, the data transfer should be high than [SDRAM](#). RDRAM is cascaded in channel operation. For Intel 820, only one RDRAM channel is supported, 16-bit data per channel, and this channel may have maximum 32 RDRAM devices, no matter how many [RIMM](#) sockets.

## ***RIMM***

184-pin memory module that supports [RDRAM](#) memory technology. A RIMM memory module may contain up to maximum of 16 RDRAM devices.

## ***SDRAM (Synchronous DRAM)***

SDRAM is one of the DRAM technologies that allows DRAM to use the same clock as the CPU host bus ([EDO](#) and FPM are asynchronous and do not have clock signal). It is similar as [PBSRAM](#) to use burst mode transfer. SDRAM comes in 64-bit 168-pin [DIMM](#) and operates at 3.3V. AOpen is the first company to support dual-SDRAM DIMMs onboard (AP5V), from Q1 1996

### ***SIMM (Single In Line Memory Module)***

SIMM socket is only 72-pin, and is only single side. The golden finger signals on each side of PCB are identical. That is why it was called Single In Line. SIMM is made by FPM or [EDO](#) DRAM and supports 32-bit data. SIMM had been phased out on current motherboard design.

### ***SMBus (System Management Bus)***

SMBus is also called I2C bus. It is a two-wire bus developed for component communication (especially for semiconductor IC). For example, set clock of clock generator for jumper-less motherboard. The data transfer rate of SMBus is only 100Kbit/s, it allows one host to communicate with CPU and many masters and slaves to send/receive message.

### ***SPD (Serial Presence Detect)***

SPD is a small ROM or [EEPROM](#) device resided on the [DIMM](#) or [RIMM](#). SPD stores memory module information such as DRAM timing and chip parameters. SPD can be used by [BIOS](#) to decide best timing for this DIMM or RIMM.

### ***Ultra DMA/33***

Unlike traditional PIO/DMA mode, which only uses the rising edge of IDE command signal to transfer data. UDMA/33 uses both rising edge and falling edge, the data transfer rate is double of the PIO mode 4 or DMA mode 2.

16.6MB/s x2 = 33MB/s

## **USB (Universal Serial Bus)**

USB is a 4-pin serial peripheral bus that is capable of cascading low/medium speed peripherals (less than 10Mbit/s) such as keyboard, mouse, joystick, scanner, printer and modem. With USB, the traditional complex cables from back panel of your PC can be eliminated.

## **ZIP file**

A compressed file format to reduce file size. To unzip file, run shareware PKUNZIP (<http://www.pkware.com/>) for DOS and other operating system or WINZIP (<http://www.winzip.com/>) for windows environment.



# Troubleshooting

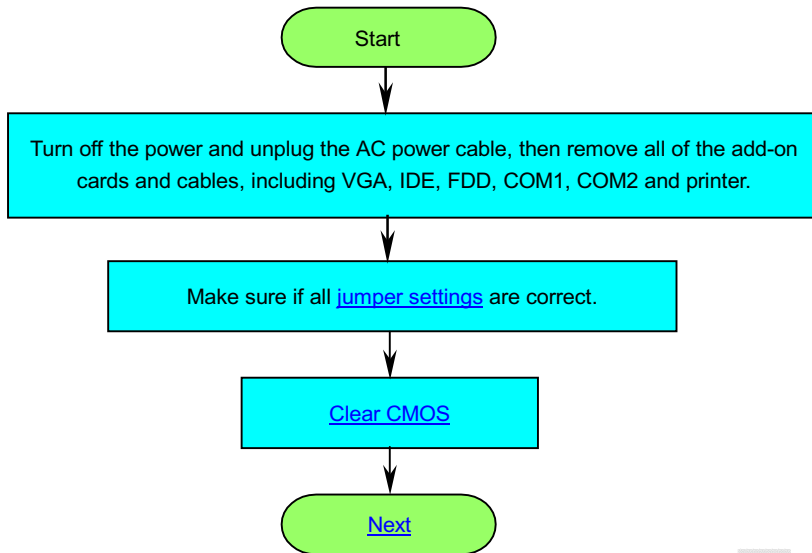

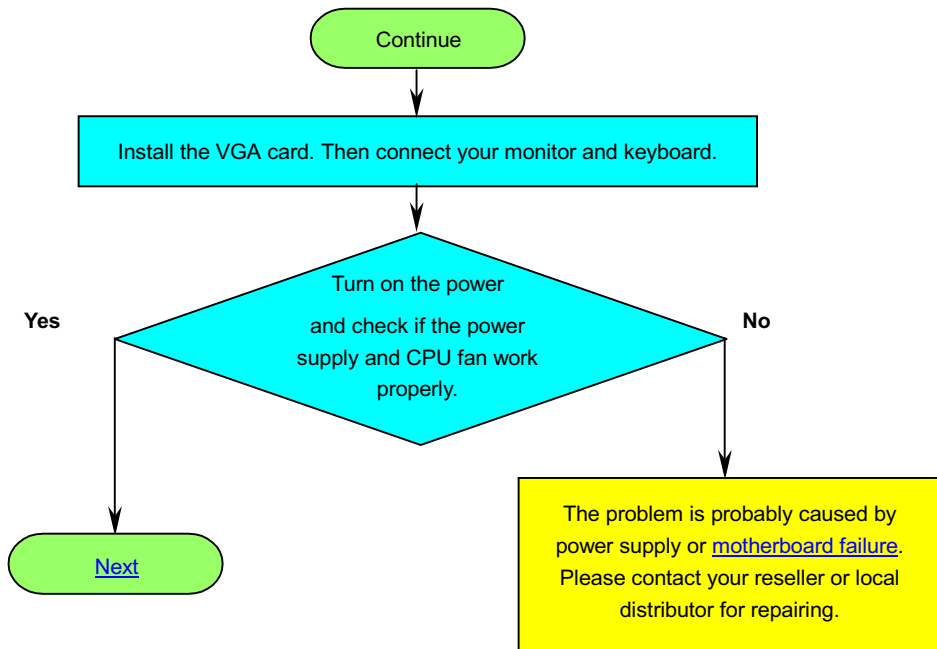



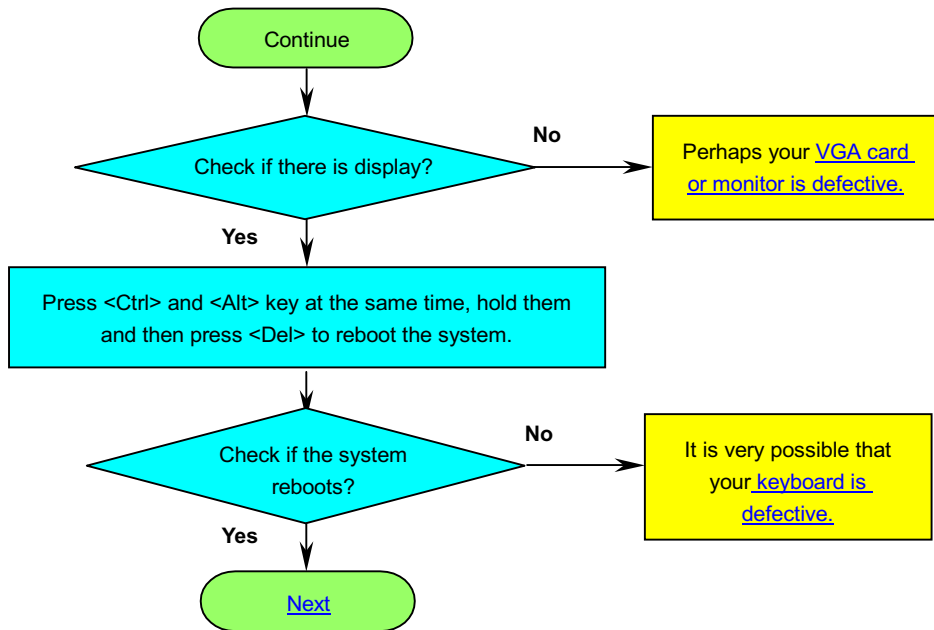

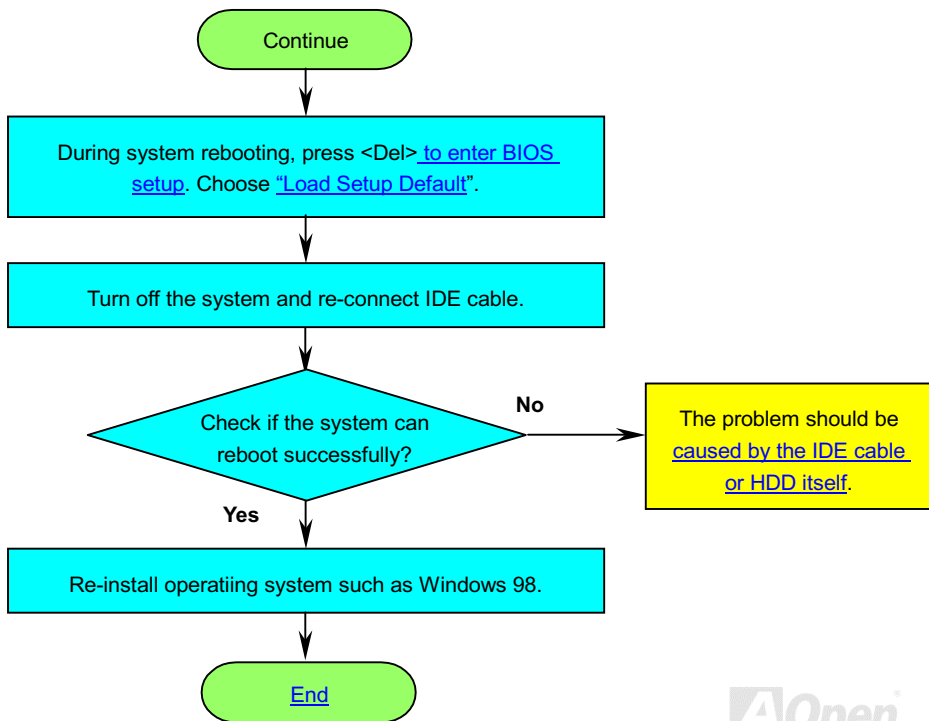



# Technical Support

Dear Customer,

Thanks for choosing AOpen products. To provide the best and fastest service to our customer is our first priority. However, we receive numerous emails and phone-calls worldwide everyday, it is very hard for us to serve everyone on time. We recommend you follow the procedures below and seek help before contact us. With your help, we can then continue to provide the best quality service to more customers.

Thanks very much for your understanding!

AOpen Technical Supporting Team

1

**Online Manual:** Please check the manual carefully and make sure the jumper settings and installation procedure are correct.

<http://www.aopen.com.tw/tech/download/manual/default.htm>

2

**Test Report:** We recommend to choose board/card/device from the compatibility test reports for assembling your PC.

<http://www.aopen.com.tw/tech/report/default.htm>

**3**

**FAQ:** The latest FAQ (Frequently Asked Questions) may contain a solution to your problem.

<http://www.aopen.com.tw/tech/faq/default.htm>

**4**

**Download Software:** Check out this table to get the latest updated BIOS/utility and drivers.

<http://www.aopen.com.tw/tech/download/default.htm>

**5**

**News Group:** Your problem probably had been answered by our support engineer or professional users on the news group.

<http://www.aopen.com.tw/tech/newsgrp/default.htm>

**6**

**Contact Distributors/Resellers:** We sell our products through resellers and integrators. They should know your system configuration very well and should be able to solve your problem more efficiently than us. After all, their attitude of service is an important reference for you if next time you want to buy something else from them.

**7**

**Contact Us:** Please prepare detail system configuration and error symptom before contacting us. The **part number**, **serial number** and **BIOS version** are also very helpful.

### *Part Number and Serial Number*

The Part Number and Serial number are printed on bar code label. You can find this bar code label on the outside packing, on ISA/CPU slot or on component side of PCB. For example:

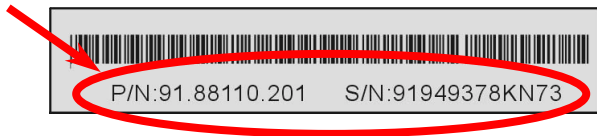

**P/N: 91.88110.201** is part number, **S/N: 91949378KN73** is serial number

### ***Model name and BIOS version***

Model name and BIOS version can be found on upper left corner of first boot screen ([POST](#) screen).

For example:

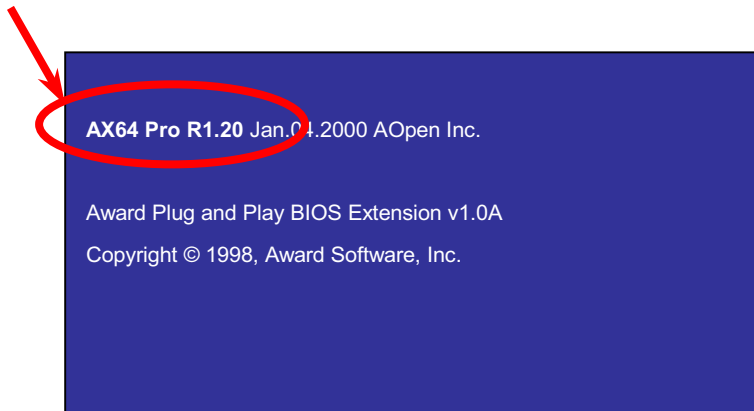

**AX64 Pro** is model name of motherboard, **R1.20** is BIOS version.

Web: <http://www.aopen.com>

Email : Send us email by going through the contact form below.

English <http://www.aopen.com.tw/tech/contact/techusa.htm>

Japanese <http://aojp.aopen.com.tw/tech/contact/techjp.htm>

Chinese <http://w3.aopen.com.tw/tech/contact/techtw.htm>

German <http://www.aopencom.de/tech/contact/techde.htm>

Simplified Chinese <http://www.aopen.com.cn/tech/contact/techcn.htm>

**TEL:**

USA	650-827-9688
Netherlands	+31 73-645-9516
China	(86) 755-375-3013
Taiwan	(886) 2-2696-1333
Germany	+49 (0) 2102-157-700