

FCC Compliance Statement:

<p style="text-align: center;">DECLARATION OF CONFORMITY <small>Per FCC Part 2 Section 2.107(f)</small></p> <p style="text-align: center;">FC</p> <p>Responsible Party Name: G.B.T. INC.</p> <p style="text-align: center;">Address: 1806 Valley Blvd., Suite#A LA Puente, CA 91744</p> <p style="text-align: center;">Phone/Fax No: (818) 854-9338 / (818) 854-9339</p> <p>hereby declares that the product</p> <p style="text-align: center;">Product Name: Mother Board</p> <p style="text-align: center;">Model Number: GA-8TX</p> <p>Conforms to the following specifications:</p> <p style="text-align: center;">FCC Part 15, Subpart B, Section 15.107(a) and Section 15.109(a). Class B Digital Device.</p> <p>Supplementary Information:</p> <p style="text-align: center;"><small>This device complies with part 15 of the FCC Rules. Operation is subject to the following two conditions: (1) This device may not cause harmful and (2) this device must accept any interference received, including that may cause undesired operation.</small></p> <p>Representative Person's Name: <u>ERIC LI</u></p> <p>Signature: <u>Eric Li</u></p> <p>Date: <u>Oct 23, 2000</u></p>

This equipment has been tested and found to comply with limits for a Class B digital device , pursuant to Part 15 of the FCC rules. These limits are designed to provide reasonable protection against harmful interference in residential installations. This equipment generates, uses, and can radiate radio frequency energy, and if not installed and used in accordance with the instructions, may cause harmful interference to radio communications. However, there is no guarantee that interference will not occur in a particular installation. If this equipment does cause interference to radio or television equipment reception, which can be

determined by turning the equipment off and on, the user is encouraged to try to correct the interference by one or more of the following measures:

- Reorient or relocate the receiving antenna
- Move the equipment away from the receiver
- Plug the equipment into an outlet on a circuit different from that to which the receiver is connected
- Consult the dealer or an experienced radio/television technician for additional suggestions

You are cautioned that any change or modifications to the equipment not expressly approve by the party responsible for compliance could void Your authority to operate such equipment.

This device complies with Part 15 of the FCC Rules. Operation is subjected to the following two conditions 1) this device may not cause harmful interference and 2) this device must accept any interference received, including interference that may cause undesired operation.

Declaration of Conformity

We, Manufacturer/Importer
(full address)

G.B.T. Technology Trading GmbH
Ausschlagler Weg 41, 1F, 20537 Hamburg, Germany

declare that the product
(description of the apparatus, system, installation to which it refers)

Mother Board
GA-8TX

is in conformity with
(reference to the specification under which conformity is declared)
in accordance with 89/336 EEC-EMC Directive

- | | | | |
|---|--|--|--|
| <input type="checkbox"/> EN 55011 | Limits and methods of measurement of radio disturbance characteristics of industrial, scientific and medical (ISM) high frequency equipment | <input checked="" type="checkbox"/> EN 61000-3-2*
<input checked="" type="checkbox"/> EN60555-2 | Disturbances in supply systems caused by household appliances and similar electrical equipment "Harmonics" |
| <input type="checkbox"/> EN55013 | Limits and methods of measurement of radio disturbance characteristics of broadcast receivers and associated equipment | <input type="checkbox"/> EN61000-3-3*
<input checked="" type="checkbox"/> EN60555-3 | Disturbances in supply systems caused by household appliances and similar electrical equipment "Voltage fluctuations" |
| <input type="checkbox"/> EN 55014 | Limits and methods of measurement of radio disturbance characteristics of household electrical appliances, portable tools and similar electrical apparatus | <input checked="" type="checkbox"/> EN 50081-1
<input checked="" type="checkbox"/> EN 50082-1 | Generic emission standard Part 1: Residual, commercial and light industry
Generic immunity standard Part 1: Residual, commercial and light industry |
| <input type="checkbox"/> EN 55015 | Limits and methods of measurement of radio disturbance characteristics of fluorescent lamps and luminaries | <input type="checkbox"/> EN 55081-2 | Generic emission standard Part 2: Industrial environment |
| <input type="checkbox"/> EN 55020 | Immunity from radio interference of broadcast receivers and associated equipment | <input type="checkbox"/> EN 55082-2 | Generic immunity standard Part 2: Industrial environment |
| <input checked="" type="checkbox"/> EN 55022 | Limits and methods of measurement of radio disturbance characteristics of information technology equipment | <input type="checkbox"/> ENV 55104 | Immunity requirements for household appliances tools and similar apparatus |
| <input type="checkbox"/> DIN VDE 0855
<input type="checkbox"/> part 10
<input type="checkbox"/> part 12 | Cabled distribution systems; Equipment for receiving and/or distribution from sound and television signals | <input type="checkbox"/> EN 50091- 2 | EMC requirements for uninterruptible power systems (UPS) |

CE marking



(EC conformity marking)

The manufacturer also declares the conformity of above mentioned product with the actual required safety standards in accordance with LVD 73/23 EEC

- | | | | |
|-----------------------------------|---|-------------------------------------|---|
| <input type="checkbox"/> EN 60065 | Safety requirements for mains operated electronic and related apparatus for household and similar general use | <input type="checkbox"/> EN 60950 | Safety for information technology equipment including electrical business equipment |
| <input type="checkbox"/> EN 60335 | Safety of household and similar electrical appliances | <input type="checkbox"/> EN 50091-1 | General and Safety requirements for uninterruptible power systems (UPS) |

Manufacturer/Importer

Signature : Rex Lin

Name : Rex Lin

(Stamp)

Date : Oct. 23, 2000

8TX
Pentium 4 Processor
Motherboard

USER'S MANUAL

Processor[®] 4 Motherboard
REV. 1.0 First Edition
R-10-01-010120

How This Manual Is Organized

This manual is divided into the following sections:

1) Revision List	Manual revision information
2) Item Checklist	Product item list
3) Features	Product information & specification
4) Installation Guide	Instructions on CPU & Memory Installation
5) Performance & Block Diagram	Product performance & block diagram
6) Suspend to RAM & Dual BIOS	Instructions on STR & Dual BIOS installation
7) Four Speaker & SPDIF	Four Speaker & SPDIF introduction
8) @ BIOS™ & EasyTuneIII™	@ BIOS™ & EasyTuneIII™ introduction
9) BIOS Setup	Instructions on setting up the BIOS software
10) Appendix	General reference

Table Of Content

Revision History	P.1
Item Checklist	P.2
Summary of Features	P.3
8TX Motherboard Layout	P.5
Installation Guide	P. 6
Page Index for Connectors / Panel and Jumper Definition	P.13
Performance List	P.34
Block Diagram	P.35
Suspend to RAM Installation	P.36
Dual BIOS Introduction (Optional)	P.42
Four Speaker & SPDIF Introduction (Optional)	P.49
@ BIOS™ Introduction (Optional)	P.55
EasyTuneIII™ Introduction (Optional)	P.56
Page Index for BIOS Setup	P.57
Field Application Record	P.85
Appendix	P.86

Revision History

Revision	Revision Note	Date
1.0	Initial release of the 8TX motherboard user's manual.	Jan.2001

The author assumes no responsibility for any errors or omissions that may appear in this document nor does the author make a commitment to update the information contained herein. Third-party brands and names are the property of their respective owners. Sound Blaster is a registered trademark of Creative Technology Ltd in the United States and certain other countries. Sound Blaster-LINK and SB-LINK are trademarks of Creative Technology Ltd.

Jan. 20, 2001 Taipei, Taiwan, R.O.C

Item Checklist

- The 8TX Motherboard
- Cable for IDE / Floppy device
- CD (8TX Driver CD) for motherboard utilities
- 8TX User's Manual
- Processor heat sink attach clips x 2
- Screw x 4

Features Summary

Form factor	<ul style="list-style-type: none"> 30.4 cm x 24.3 cm ATX size form factor, 6 layers PCB.
CPU	<ul style="list-style-type: none"> Socket 423 processor <ul style="list-style-type: none"> Intel Pentium® 4 100MHz FSB L2 cache depend on CPU
Chipset	<ul style="list-style-type: none"> 82850 HOST / AGP / RDRAM Controller 82801BA(ICH2) I/O Controller Hub
Clock Generator	<ul style="list-style-type: none"> Supports 100 MHz
Memory	<ul style="list-style-type: none"> 4 184-pin RIMM Sockets Dual direct RAMBUS channel Supports up to 2GB (Max)
I/O Control	<ul style="list-style-type: none"> Winbond W83627HF
Slots	<ul style="list-style-type: none"> 1 CNR slot 1 Universal AGP Pro slot 4X 1.5V device support 5 PCI slots support 33MHz & PCI 2.2 compliant
On-Board IDE	<ul style="list-style-type: none"> An IDE controller on the Intel® 82801BA PCI chipset provides IDE HDD/ CD-ROM with PIO, Bus Master (Ultra DMA33/ATA66/ATA100) operation modes Can connect up to four IDE devices
On-Board Peripherals	<ul style="list-style-type: none"> 1 Floppy port supports 2 FDD with 360K, 720K, 1.2M, 1.44M and 2.88M bytes 1 Parallel port supports Normal/EPP/ECP mode 2 Serial ports (COM A & COM B) 4 USB ports (Front USB port optional for 8TX) 1 IrDA connector for IR/CIR
Hardware Monitor (Optional)	<ul style="list-style-type: none"> CPU/Power/System Fan Revolution detect CPU Fan Control System Voltage Detect CPU Overheat Warning Chassis Intrusion Detect Display Actual Current Voltage
On-Board Sound	<ul style="list-style-type: none"> Creative CT5880 sound (Optional for 8TX) AC'97 CODEC Line In/Line Out/Mic In/AUX In/CD In/TEL/Game Port SPDIF and Four Speaker (Optional for 8TX)
PS/2 Connector	<ul style="list-style-type: none"> PS/2® Keyboard interface and PS/2® Mouse interface

To be continued...

BIOS	<ul style="list-style-type: none">• Licensed AMI BIOS, 4M bit FWH• Support Dual BIOS
Additional Features	<ul style="list-style-type: none">• Internal/External Modem wake up• STR (Suspend-To-RAM)• Wake On LAN• PS/2 Keyboard password power on• PS/2 Mouse power on• System after AC back• Poly fuse for keyboard, USB, game port over-current protection• USB KB/MS wake up from S3

8TX Motherboard Layout

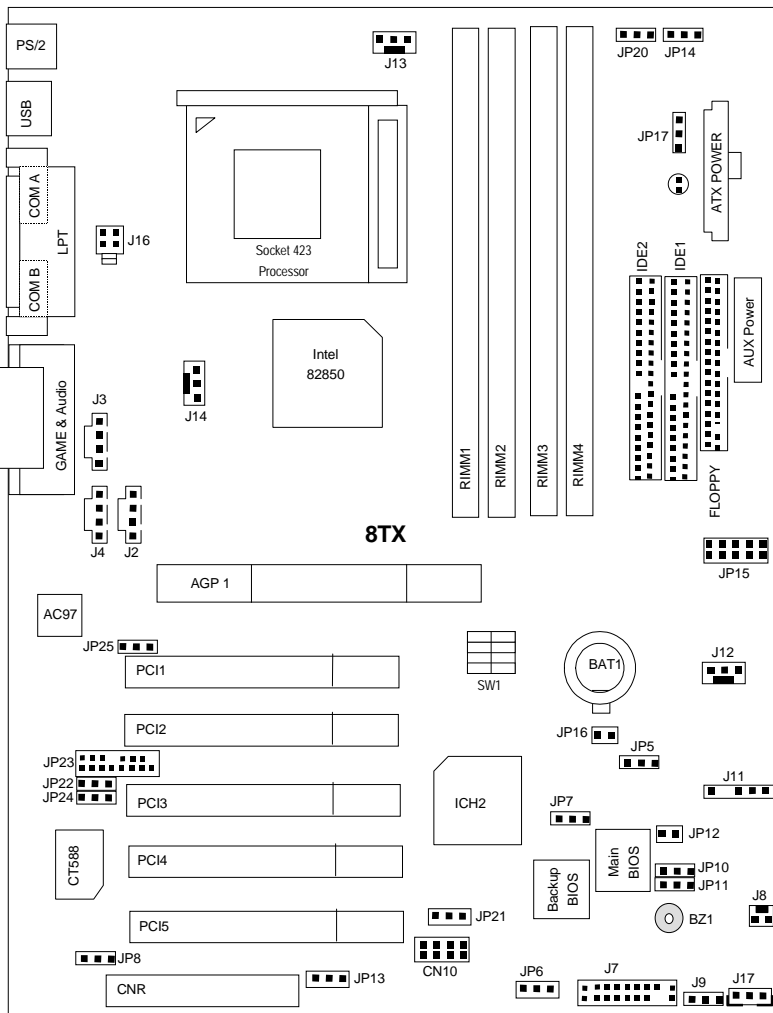

Installation Guide

Getting Started



WARNING!

Computer motherboards and expansion cards contain very delicate Integrated Circuit (IC) chips. To protect them against damage from static electricity, you should follow some precautions whenever you work on your computer.

1. Unplug your computer when working on the inside.
2. Use a grounded wrist strap before handling computer components. If you do not have one, touch both of your hands to a safely grounded object or to a metal object, such as the power supply case.
3. Hold components by the edges and try not touch the IC chips, leads or connectors, or other components.
4. Place components on a grounded antistatic pad or on the bag that came with the components whenever the components are separated from the system.
5. Ensure that the ATX power supply is switched off before you plug in or remove the ATX power connector on the motherboard.

Installing the motherboard to the chassis...

If the motherboard has mounting holes, but they don't line up with the holes on the base and there are no slots to attach the spacers, do not become alarmed you can still attach the spacers to the mounting holes. Just cut the bottom portion of the spacers (the spacer may be a little hard to cut off, so be careful of your hands). In this way you can still attach the motherboard to the base without worrying about short circuits. Sometimes you may need to use the plastic springs to isolate the screw from the motherboard PCB surface, because the circuit wire may be near by the hole. Be careful, don't let the screw contact any printed circuit write or parts on the PCB that are near the fixing hole, otherwise it may damage the board or cause board malfunctioning.

8TX Motherboard

You may use the 4 screws which come with the mainboard to reinforce the support between P4 CPU heat-sink on the mainboard and chassis.

Please note! In order to follow the installation steps below; your chassis must be WILLMETTE/850 board design compatible.

Step1: The 4 new mounting holes on the chassis are for additional support for P4 CPU heat-sink on the mainboard.

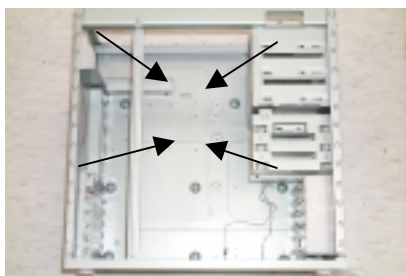

Figure1

Step2: Please remove 4 sets of plastic Push-pins as indicated on Figure2. Remove the white pins first, then black pins as indicated on Figure3.

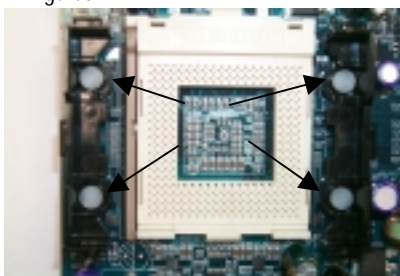

Figure2

Step3:



Figure3

Step4: Fit the 4 screws with 2 CPU retention modules on the chassis..

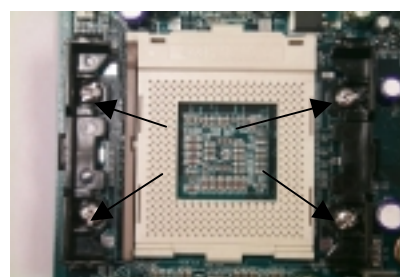
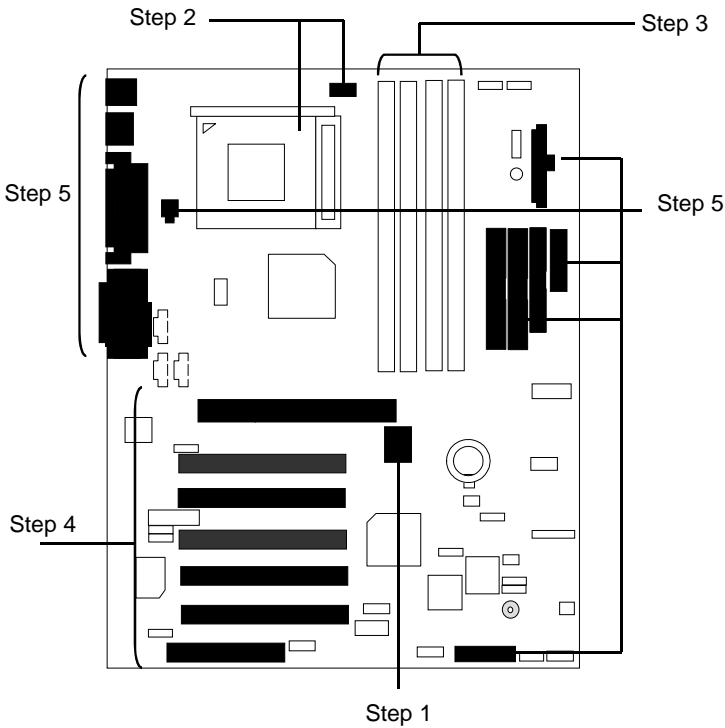

Figure4

To set up your computer, you must complete the following steps:

- ▶ Step 1 - Set system jumpers
- ▶ Step 2- Install the Central Processing Unit (CPU)
- ▶ Step 3-Install memory modules
- ▶ Step 4-Install expansion cards
- ▶ Step 5-Connect ribbon cables, cabinet wires, and power supply
- ▶ Step 6-Set up BIOS software
- ▶ Step 7-Install supporting software tools



CPU Speed Setup

The system bus frequency can be switched at 100MHz - 133MHz by adjusting SW 1. (The frequency ratio depend on CPU).

SW1 Select the System Speed at 100MHz - 133MHz.

CPU CLK	1	2	3	4
*100MHz	ON	ON	ON	ON
105MHz	OFF	OFF	ON	ON
110MHz	OFF	ON	OFF	ON
133MHz	ON	ON	ON	OFF

***We recommend you to setup your system speed to 100MHz.**

CPU Installation

Please make sure the CPU should be supported to the motherboard.



CPU Top

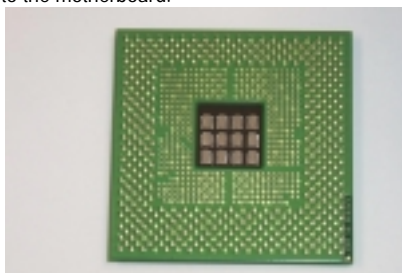

CPU Bottom

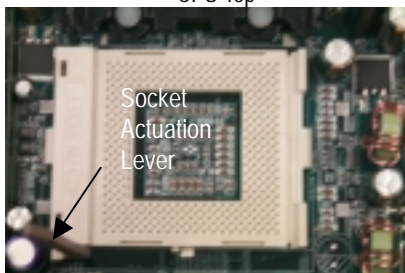

1. Pull the lever out, then lift up the Lever.

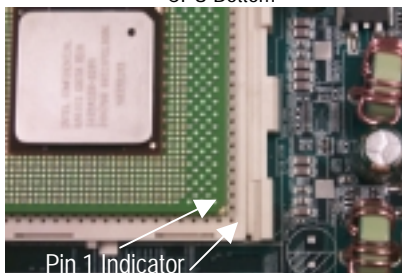

2. Please make sure the Pin1 indicator (gold color) is aligned with 423pinsocket.

CPU Heat Sink Installation:

Beware: Please check that the heat sink is in good contact with the CPU before you turn on your system. **A poor contact will cause over heat, and might cause damage to your processor!**



3. Align CPU and insert it

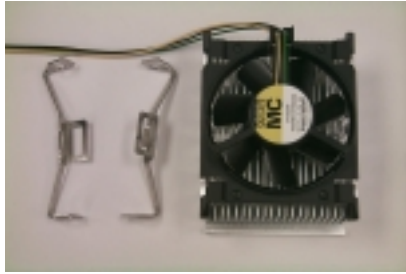

4. Use qualified fan approved by Intel.

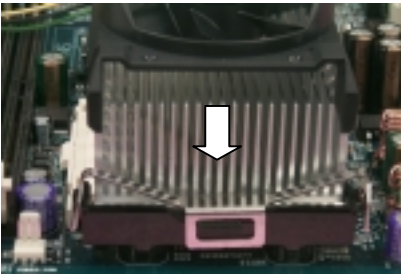

5. Slip the bracket on to the CPU retention and press both end to clip it on the retention.

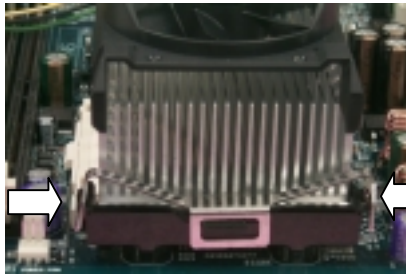

6. Make sure the CPU fan is plugged to the CPU fan connector, then install complete.

 (Please refer to the cooler's installation manual for detailed installation steps)

ATX 12V Power Supply

- Additional 4 pin connector for 12V current
- Backward compatibility maintained with load sharing capability
- Support 12V or 5V CPU VRs

Check power supply if it is supported by ATX12V Power Supply.

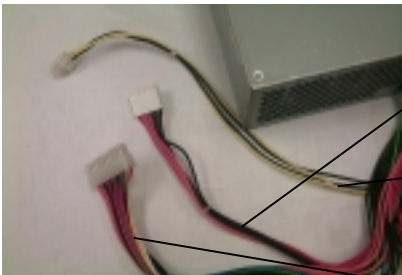

6Pin auxiliary ATX power connector

Additional dedicated 12V 4-pin power connector

ATX power connector

Memory Installation

The motherboard has 4 Rambus In-line Memory Module (RIMM) sockets. The BIOS will automatically detects memory type and size. To install the memory module, just push it vertically into the RIMM Slot .The RIMM module can only fit in one direction due to the two notches. Please note; Both RIMM modules inserted on RIMM1 and RIMM2 slots are recommended to have the same size, frequency. If not, the larger sized module will be automatically re-sized by BIOS to match the smaller sized module. The same rule applies to both RIMM3 and RIMM4 slots.

You can insert two RIMMs or four RIMMs into RIMM slots, but C-RIMM (Continuity RIMM) modules must be inserted into the empty slots.

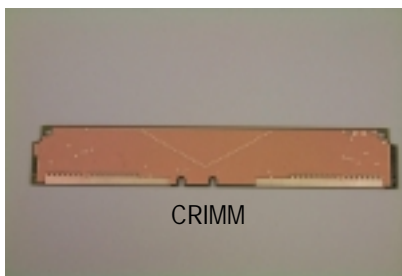
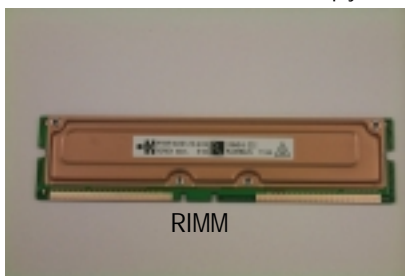

Check RIMM module if it is supported by the M/B.

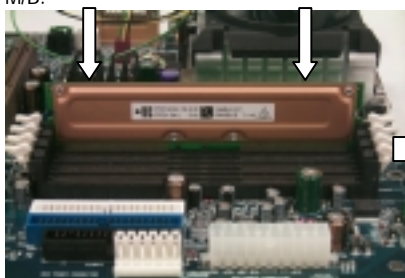

Insert the RIMM module into the slot.



Push the ejector tab towards the RIMM.

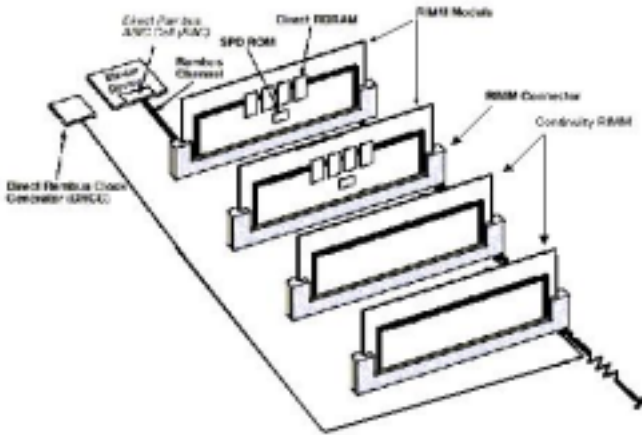

Introduce RIMM (Rambus In-line Memory Module)

Direct Rambus Memory Controller

⇒ Directly support a Dual Direct Rambus * Channel

- Supports 300&400 MHz Direct Rambus * Channel @ 100MHz host bus frequency.
- Maximum memory array size up to 256MB using 64Mb/72Mb, 512MB using 128Mb/144Mb, 1GB using 256Mb/288Mb DRAM technology

⇒ Supports up to 32 Direct Rambus devices per channel

⇒ Supports a maximum DRAM address decode space of 4GB

⇒ Configurable optional ECC operation

- ECC with single bit Error Correction and multiple bit Error Detection
- Single bit errors corrected and written back to memory (auto-scrubbing)
- Parity mode not supported

APIC memory space in hardware. It is the BIOS or system designer's responsibility to limit DRAM population so that adequate PCI, AGP, High BIOS, and APIC memory space can be allocated.

8TX Motherboard

Page Index for Connectors/Panel and Jumper Definition	Page
Connectors	P.15
ATX Power	P.15
Aux. Power	P.15
COM A / COM B / LPT Port	P.16
CN6 (PS/2 Keyboard & PS/2 Mouse Connector)	P.16
CN7 (USB Connector)	P.17
CN10 (Front USB Connector)	P.17
Floppy Port	P.18
Game & Audio Port	P.18
IDE 1/IDE 2 (Primary/ Secondary) Port	P.19
J2 (CD Audio Line In)	P.19
J3 (AUX_IN)	P.20
J4 (TEL)	P.20
J8 (Ring Power On)	P.21
J11 (External SMBUS Device Connector)	P.21
J12 (System FAN)	P.22
J13 (Power FAN)	P.22
J14 (CPU FAN)	P.23
J16 (ATX +12V Power Connector)	P.23
J17 (Wake On LAN)	P.23
JP12 (STR LED Connector)	P.24
JP15 (IR/CIR)	P.25
JP23 (Front Audio)	P.25
Panel and Jumper Definition	P.25
J7 (2x11 pins jumper)	P.26
J9 (Internal Buzzer Connector)(Optional)	P.26
JP5 (Clear CMOS Function)	P.27
JP6 (Safe mode/Recovery/Normal)	P.28
JP7 (Timeout Reboot Function)	P.28
JP8 (Onboard Sound Function Selection)	P.29
JP10 (Top Block Lock)	P.29
JP11 (BIOS Write Protection)	P.30
JP13 (AMR/CNR Select)	P.30
JP14 (PS/2 Keyboard Power On)(Back)	P.31

JP16 (Case Open)	P.31
JP17 (STR Selection)	P.32
JP20 (Rear USB Device Wake up Selection)	P.32
JP21 (Front USB Device Wake Up Selection)	P.33
BAT 1(Battery)	P.33

Connectors

ATX Power

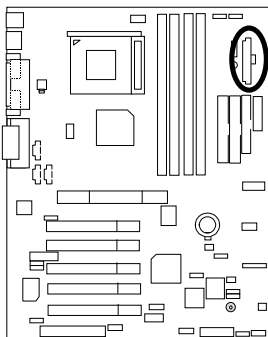

Pin No.	Definition
3,5,7,13,15-17	GND
1,2,11	3.3V
4,6,19,20	VCC
10	+12V
12	-12V
18	-5V
8	Power Good
9	5V SB (stand by+5V)
14	PS-ON(Soft On/Off)



Please note:

AC power cord should only be connected to your power supply unit after ATX power cable and other related devices are firmly connected to the mainboard.

Aux. Power

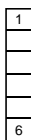
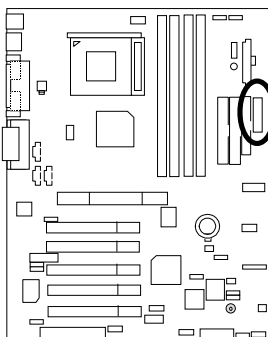

Pin No.	Definition
1,2,3	GND
4,5	+3.3VDC
6	+5VDC



Please note:

The 6-pin Aux. Power connector provides additional current to meet the board's +3.3VDC and +5VDC requirements.

COM A / COM B / LPT Port

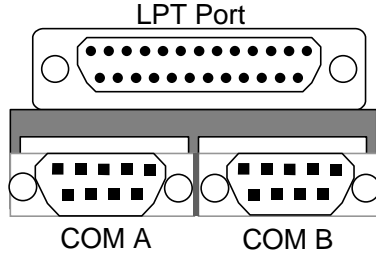
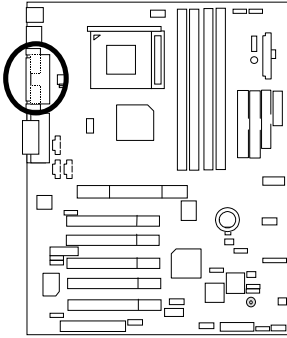
**Please note:**

This mainboard supports 2 standard COM ports and 1 LPT port. Device like printer can be connected to LPT port ; mouse and modem etc can be connected to COM ports.

CN6 : PS/2 Keyboard & PS/2 Mouse Connector

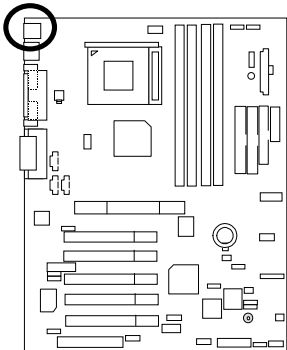

PS/2 Mouse

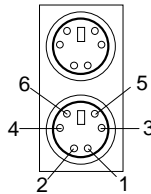

PS/2 Keyboard

PS/2 Mouse/ Keyboard	
Pin No.	Definition
1	Data
2	NC
3	GND
4	VCC(+5V)
5	Clock
6	NC

**Please note:**

This mainboard supports standard PS/2 keyboard and PS/2 mouse interface connector.

CN7 : USB Connector

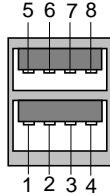
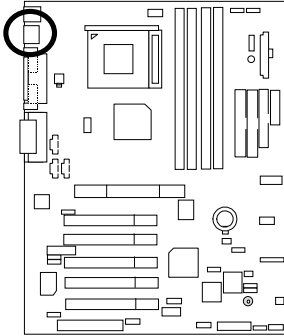

Pin No.	Definition
1	USB V0
2	USB D0-
3	USB D0+
4	GND
5	USB V1
6	USB D1-
7	USB D1+
8	GND



Please note: Before you connect your device(s) into USB connector(s), please make sure your device(s) such as USB keyboard, mouse, scanner, zip, buzzer..etc. have a standard USB interface. Also make sure your OS (Win 95 w/ USB supperment, Win98, Windows 2000, Windows ME, Win NT w/ SP 6) supports USB controller. If your OS does not support USB controller, please contact OS venders for possible patch or driver upgrade. For more information please contact your OS or device(s) venders.

CN10 : Front USB Connector

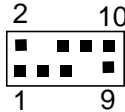
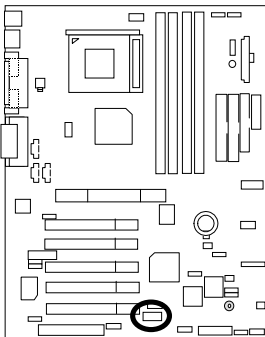

Pin No.	Definition
1	5V-SB
2	GND
3	USB D2-
4	NC
5	USB D2+
6	USB D3+
7	NC
8	USB D3-
9	GND
10	5V-SB



Please note: Be careful with the polarity of the front panel USB connector. Check the pin assignment while you connect the front panel USB cable. Please contact your nearest dealer for optional front panel USB cable.

Floppy Port

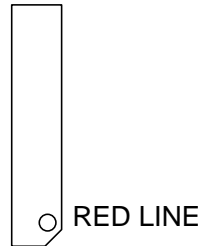
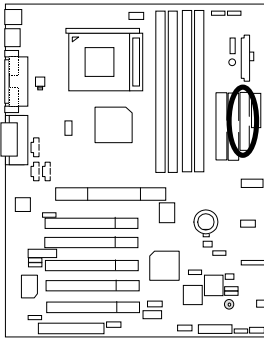

Game & Audio Port

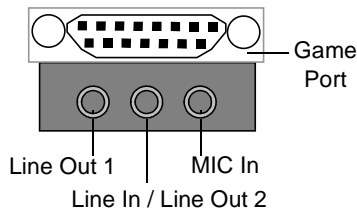
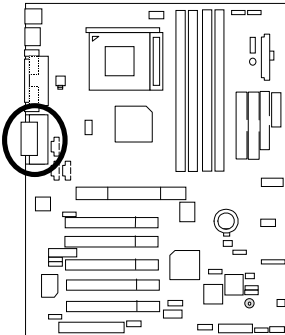

Please note: Line Out 1: Line Out or SPDIF (The SPDIF output is capable of providing digital audio to external speakers or compressed AC3 data to an external Dolby digital decoder). To enable SPDIF, simply insert SPDIF connector into Line Out1. Line Out1 will become SPDIF Out automatically. (see page 52 for more information).

To enable Four Speaker (for Creative 5880 audio only), simply follow instructions on page 49 and Line In will become Line Out2 to support second pair of stereo speakers.

IDE1(Primary) , IDE2 (Secondary) Port

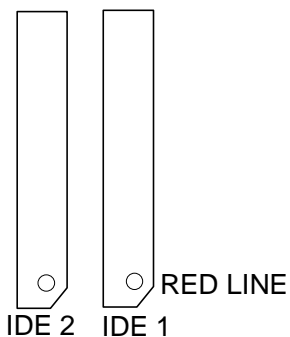
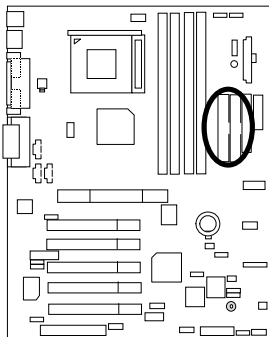

J2 : CD Audio Line In

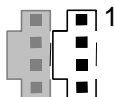
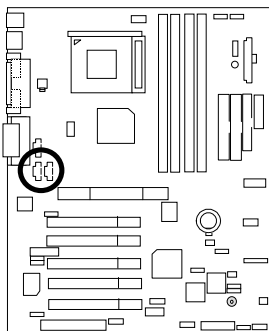

Pin No.	Definition
1	CD-L
2	GND
3	GND
4	CD-R

J3 : AUX IN

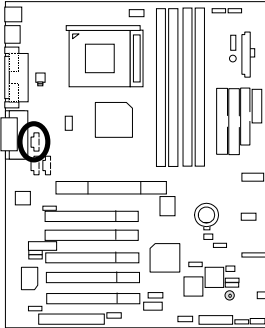

Pin No.	Definition
1	AUX-L
2	GND
3	GND
4	AUX-R

J4 : TEL(The connector is for internal modem card with voice connector)

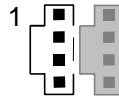
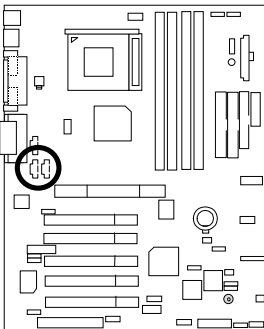

Pin No.	Definition
1	Signal-In
2	GND
3	GND
4	Signal-Out

J8 : Ring Power On

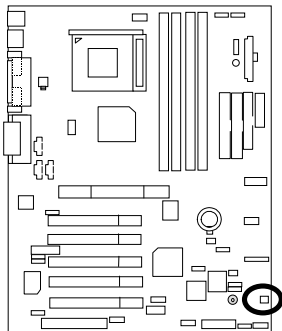

Pin No.	Definition
1	Signal
2	GND

J11 : External SMBUS Device Connector

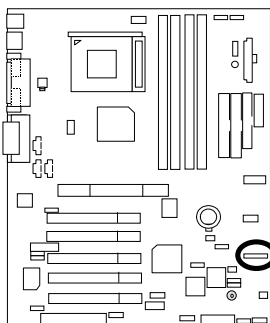

Pin No.	Definition
1	SMB CLK
2	NC
3	GND
4	SMB DATA
5	+5V

J12 : System FAN

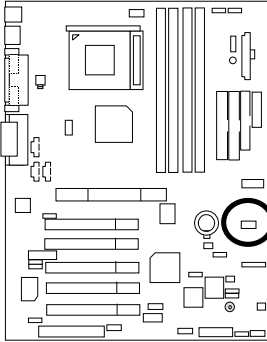

1



Pin No.	Definition
1	Control
2	+12V
3	SENSE

J13 : Power FAN

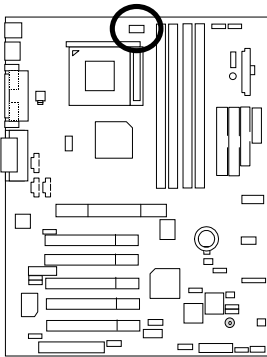

1



Pin No.	Definition
1	Control
2	+12V
3	SENSE

J14 : CPU FAN

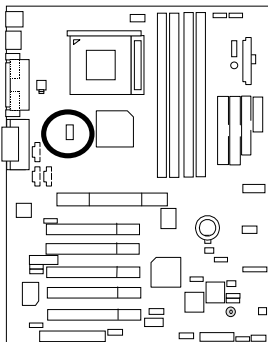

Pin No.	Definition
1	Control
2	+12V
3	SENSE



Please note, a proper installation of the CPU cooler is essential to prevent the CPU from running under abnormal condition or damaged by overheating.

J16 : ATX +12V Power Connector

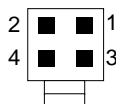
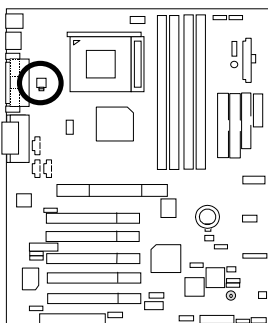

Pin No.	Definition
1	GND
2	GND
3	+12V
4	+12V



Please note, This connector (ATX +12V) is only for heavy loading AGPPRO card. (+12V power consumption above 12A)

J17 : Wake on LAN

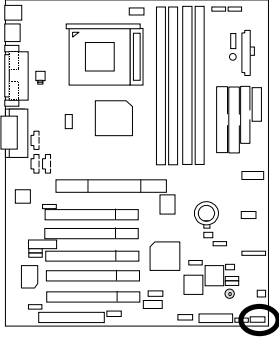

Pin No.	Definition
1	+5V SB
2	GND
3	Signal

JP12: STR LED Connector

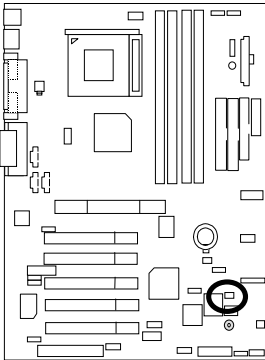

RIMM LED

STR LED Connector External

**Please note:**

Do not remove memory modules while RIMM LED is on. It might cause short or other unexpected damages due to the 2.5V stand by voltage. Remove memory modules only when STR function is disabled by jumper and AC Power cord is disconnected.

JP15 : IR/CIR

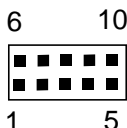
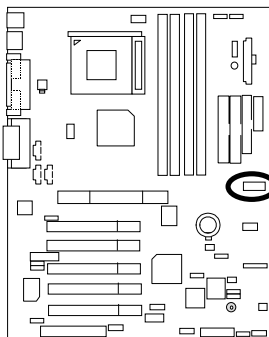

Pin No.	Definition
1	VCC
2	NC
3	IRRX
4	GND
5	IRTX
6	NC
7	CIRRX
8	VCC
9	NC
10	NC



Please note: Warning make sure that pin 1 on the IR device is align with pin one of the connector. To enable the IR/CIR function on the board, you are required to purchase an option IR/CIR module. For detail information please contact your authorized Giga-Byte distributor. To use IR function only, please connect IR module to Pin1 to Pin5..

JP23 : Front Audio

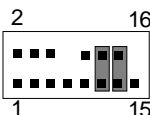
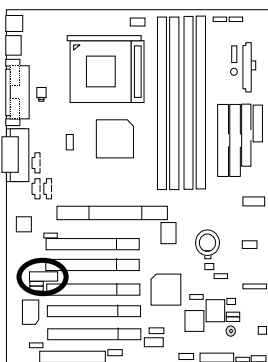

PIN NO.	Definition
1	Incase speaker (R)
2	Incase speaker (L)
3, 4, 5, 6, 10, 15	GND
7	+12V
8, 16	NC
9	MIC
11	Front Audio (R)
13	Front Audio (L)
12	Rear Audio (R)
14	Rear Audio (L)



Please note : If you want to use "Front Audio" connector, you must move 11-12,13-14 Jumper.
In order to utilize the front audio header, your chassis must have front audio connector. Also please make sure the pin assigment on the cable is the same as the pin assigment on the MB header. To find out if the chassis you are buying support front audio connector, please contact your dealer.

Panel And Jumper Definition

J7 : For 2X11 Pins Jumper

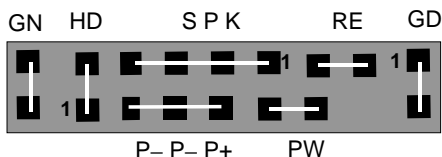
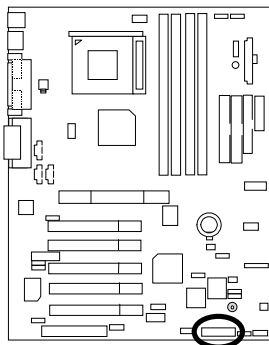

GN (Green Switch)	Open: Normal Operation Close: Entering Green Mode
GD (Green LED)	Pin 1: LED anode(+) Pin 2: LED cathode(-)
HD (IDE Hard Disk Active LED)	Pin 1: LED anode(+) Pin 2: LED cathode(-)
SPK (Speaker Connector)	Pin 1: VCC(+) Pin 2- Pin 3: NC Pin 4: Data(-)
RE (Reset Switch)	Open: Normal Operation Close: Reset Hardware System
P+P-P-(Power LED)	Pin 1: LED anode(+) Pin 2: LED cathode(-) Pin 3: LED cathode(-)
PW (Soft Power Connector)	Open: Normal Operation Close: Power On/Off



Please note, Please connect the power LED, PC speaker, reset switch and power switch etc of your chassis front panel to the front panel jumper according to the pin assignment above.

J9 : Internal Buzzer Connector(Optional)

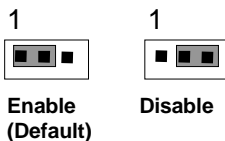
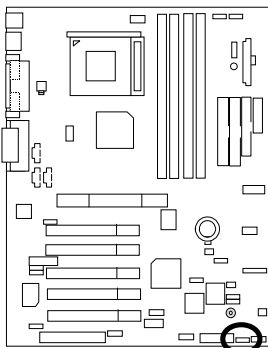

Pin No.	Definition
2-3close	Internal Buzzer Disable
1-2close	Internal Buzzer Enable (Default)

JP5 : Clear CMOS Function

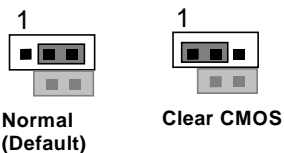
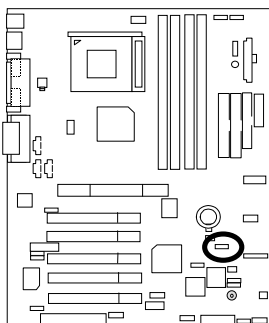

Pin No.	Definition
1-2 close	Clear CMOS
2-3 close	Normal (Default)



Please note, You may clear the CMOS data to its default values by this jumper

JP6 : Safe mode / Recovery / Normal

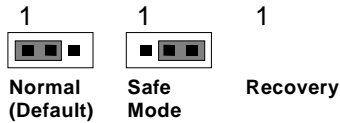
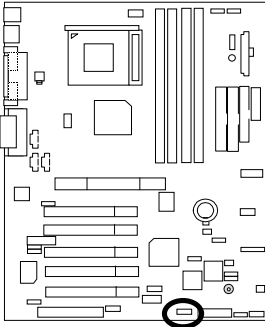

Pin No.	Definition
1-2close	Normal(Default)
2-3close	Safe mode
NC	Recovery



Please note, Sometime the system can not start up due to the setting in the CMOS/BIOS, to restore the CMOS/BIOS setting back to its safe setting the jumper can be set to 2-3. Once your system can start up you can set the jumper back to its normal position 1-2.

JP7 : Timeout Reboot Function

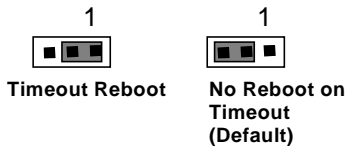
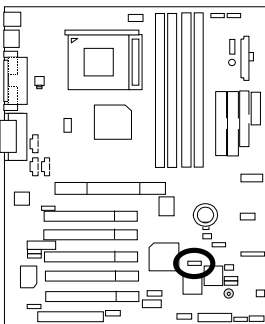

Pin No.	Definition
1-2close	Timeout reboot
2-3close	No Reboot on timeout (Default)



Please note, This MB supports time out reboot function. If the system lock up, the reboot timer will start to count. Once the timer counts to a specific value the system will reboot automatically. When this event happens the system will boot up in safe BIOS mode.

JP8 : PCI Sound Function Selection

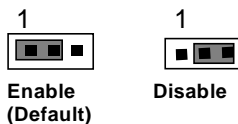
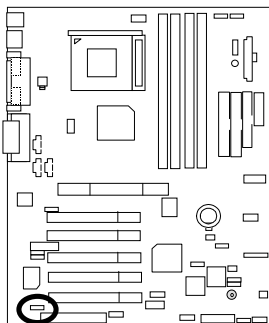

Pin No.	Definition
1-2 close	PCI Sound Enable(Default)
2-3 close	PCI Sound Disable

JP10 : Top Block Lock

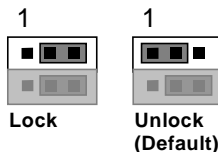
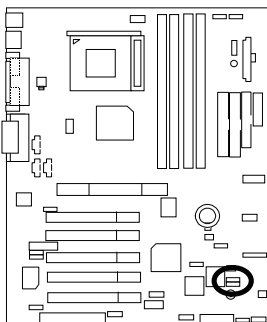

Pin No.	Definition
1-2close	Top Block Unlock (Default)
2-3close	Top Block lock



Please note, To upgrade BIOS on this M/B, JP10 must be set to 1&2.

JP11 : BIOS Write Protection

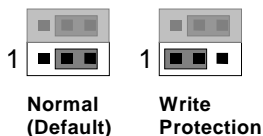
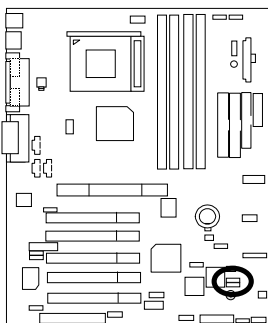

Pin No.	Definition
1-2close	Write Protection
2-3close	Normal (Default)



Please note, To flash/upgrade BIOS on this MB JP 11 must be set to 2 & 3. We recommend JP 11 to be set to 1 & 2, whenever user does not need to flash/upgrade the BIOS.

JP13 : CNR Select

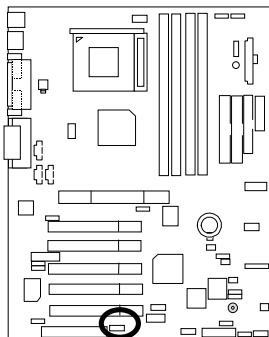

Pin No.	Definition	
	(Onboard CDOEC)	CNR Card
1-2close	Primary	Secondary
2-3close	AC'97 Disabled (Disabled Onboard CODEC)	Primary



Please note:

8TX: If M/B has hardware audio (CT5880), your modem riser has been set to "Primary" automatically. No Jumper JP13 for 8TX

8TX: JP13: 1-2 close: If you use software audio(onboard CODEC only), your modem riser must be "Secondary". JP13: 2-3 close: If you don't use onboard software audio, your audio/modem riser must be "Primary". Mainboard's software audio will be disabled.

There are two types of CNR card in the market, Primary and secondary. If your CNR card is primary, JP13 should be set to 2-3, if you have secondary CNR card JP 13 should be set to 1-2.

Warning! If Primary CNR card is used, on-board CODEC will be disabled.

JP14 : PS/2 Keyboard Power On

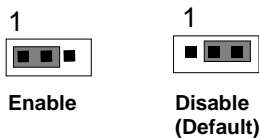
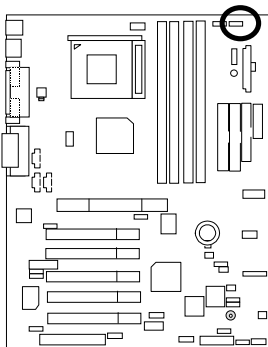

Pin No.	Definition
1-2 close	PS/2 Keyboard Power on Enabled
2-3 close	PS/2 Keyboard Power on Disabled (Default)



Please note, Please note, PS/2 keyboard power on will enable user to power on his computer by pressing the designated key/keys on the PS/2 keyboard. To enable PS/2 keyboard power on, set jumper JP14 to 1-2, and then enable the PS/2 keyboard power on function to assign the key/keys of your choice inside the BIOS setup Menu.

JP16 : Case Open

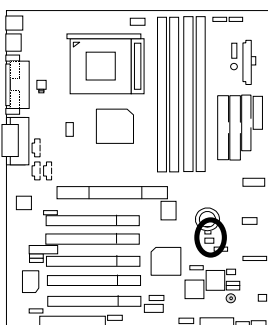

Pin No.	Definition
1	Signal
2	GND

JP17 : STR Selection

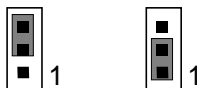
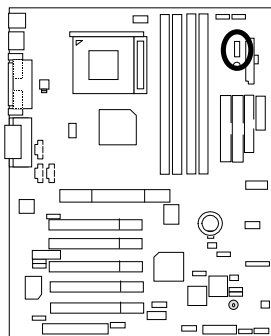

**Disabled
(Default)**

Enabled

Pin No.	Definition
2-3close	STR Disabled (Default)
1-2close	STR Enabled

JP20 : Rear USB Device Wake up Selection (USB Connector → CN7)

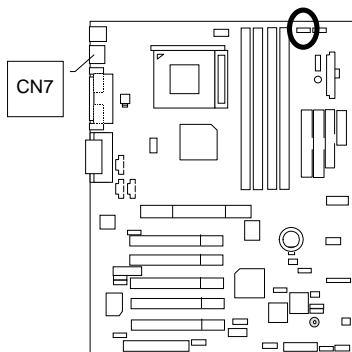

**Normal
(Default)**



Enable

Pin No.	Definition
1-2 close	Rear USB Device Wakeup Enabled
2-3 close	Normal (Default)



Please note. To use "USB KB/MS Wakeup from S3" function, set BIOS setting "USB KB/MS Wake up from S3" to ENABLED and enable jumpers JP20&JP17. To prevent user confusion, it is recommended to enable, jumper JP21 (Front USB Device wake-up function).

*(Power on the computer and as soon as memory counting starts, press . You will enter BIOS Setup. Select the item "POWER MANAGEMENT SETUP", then select "USB KB/MS Wake up from S3". Remember to save the setting by pressing "ESC" and choose the "SAVE & EXIT SETUP" option.)

JP21 : Front USB Device Wake up Selection

(USB Port → CN10)

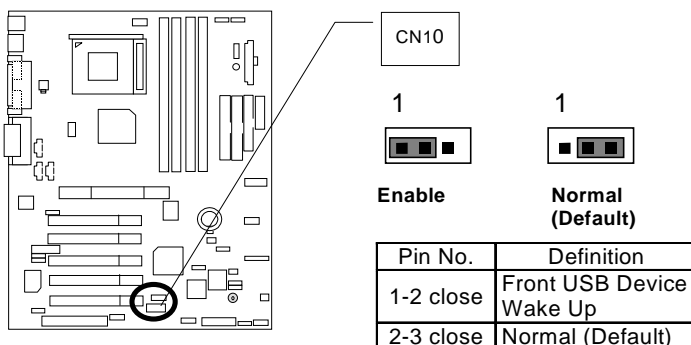

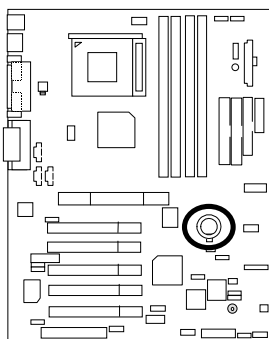

Please note, To use "USB KB/MS Wakeup from S3" function, set BIOS setting "USB KB/MS Wake up from S3" to ENABLED and enable jumpers JP21&JP17. To prevent user confusion, it is recommended to enable jumper JP20 (Rear USB Device wake-up function)..
 *(Power on the computer and as soon as memory counting starts, press . You will enter BIOS Setup. Select the item "POWER MANAGEMENT SETUP", then select "USB KB/MS Wake up from S3". Remember to save the setting by pressing "ESC" and choose the "SAVE & EXIT SETUP" option.)

BAT1 : Battery



CAUTION

-  Danger of explosion if battery is incorrectly replaced.
-  Replace only with the same or equivalent type recommended by the manufacturer.
-  Dispose of used batteries according to the manufacturer's instructions.

Performance List

The following performance table lists the results of some popular benchmark testing programs. These data are provided as reference only and in no way guarantee the system shall perform, and there is no responsibility for different testing data at exactly the same level. (The different Hardware & Software configuration will result in different benchmark testing results.)

- CPU Pentium® 4 1.5GHz processor
- DRAM (128x2) MB RDRAM (SAMSUNG MR16R0828AN1-CK8)
- CACHE SIZE 256 KB integrated in CPU
- DISPLAY GIGABYTE GF-2000 DDR1.1
- STORAGE Onboard IDE (IBM DTLA-307030)
- O.S. Windows 2000 SPK1
- DRIVER Display Driver Nvidia 0530 (NUCD 1.6C)
 (1024 x 768 x 16bit colors x 75Hz.)
 Intel inf Update V2.60.001
 Intel Ultra ATA 6.03.009

Processor		Intel Pentium® 4
		1.5GHz
System Mark 2000		
	Bryce 4	203
	Core Draw(TM)9	167
	Elastic Reality ® 3.1	169
	Excel 2000	167
	Naturallv Speaking ® Pref 4.0	156
	Netscape ® Communicator	231
Spec CPU 2000		
	SPECINT 2000	536
	SPECFP	558
Quake III Arena		
	Demo 001	154.4
	Demo 002	157.4

Block Diagram

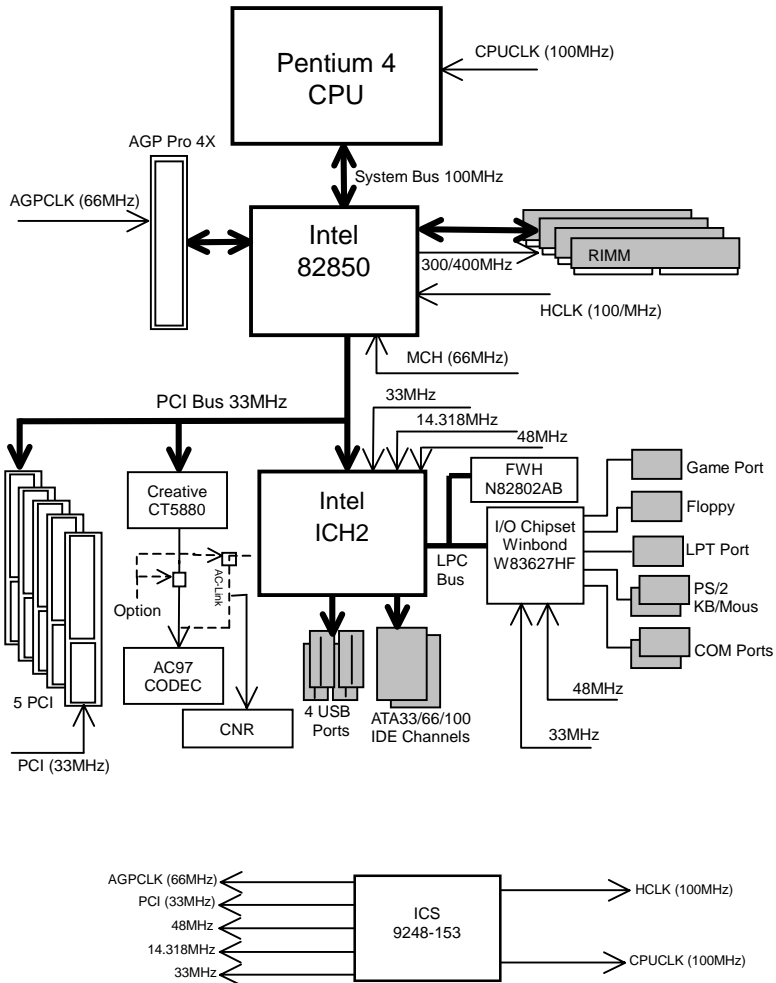

Suspend To RAM Installation

A.1 Introduce STR function:

Suspend-to-RAM (STR) is a Windows 98 ACPI sleep mode function. When recovering from STR (S3) sleep mode, the system is able, in just a few seconds, to retrieve the last "state" of the system before it went to sleep and recover to that state. The "state" is stored in memory (RAM) before the system goes to sleep. During STR sleep mode, your system uses only enough energy to maintain critical information and system functions, primarily the system state and the ability to recognize various "wake up" triggers or signals, respectively.

A.2 STR function Installation

Please use the following steps to complete the STR function installation.

Step-By-Step Setup

Step 1:

To utilize the STR function, the system must be in Windows 98 ACPI mode.

Putting Windows 98 into ACPI mode is fairly easy.

Setup with Windows 98 CD:

- A. Insert the Windows 98 CD into your CD-ROM drive, select Start, and then Run.
- B. Type (without quotes) "**D:\setup**" in the window provided. Hit the enter key or click OK.
- C. After setup completes, remove the CD, and reboot your system
(This manual assumes that your CD-ROM device drive letter is D:).

Step 2:

(If you want to use STR Function, please set jumper JP17 Pin1-2 (Closed.)

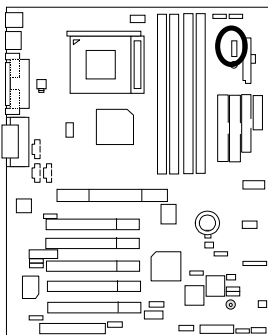

Enable

Pin No.	Definition
1-2close	STR Enabled
2-3close	STR Disabled

Step 3:

Power on the computer and as soon as memory counting starts, press . You will enter BIOS Setup. Select the item **"POWER MANAGEMENT SETUP"**, then select **"ACPI Sleep Type: S3 /STR"**. Remember to save the settings by pressing "ESC" and choose the **"SAVE & EXIT SETUP"** option.

Congratulation! You have completed the installation and now can use the STR function.

A.3 How to put your system into STR mode?

There are two ways to accomplish this:

1. Choose the "Stand by" item in the "Shut Down Windows" area.
 - A. Press the "Start" button and then select "Shut Down"



- B. Choose the "Stand by" item and press "OK"

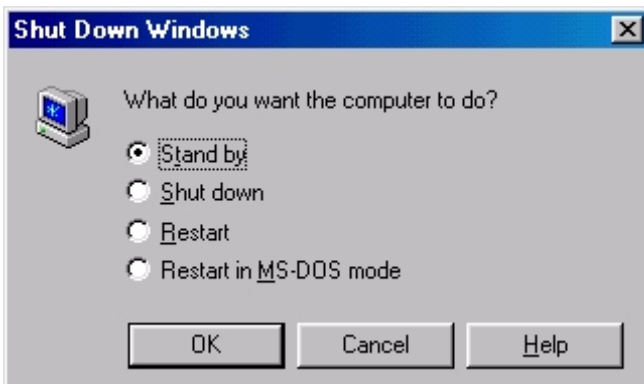

8TX Motherboard

2. Define the system "power on" button to initiate STR sleep mode:
 - A. Double click "My Computer" and then "Control Panel"



- B. Double click the " Power Management" item.

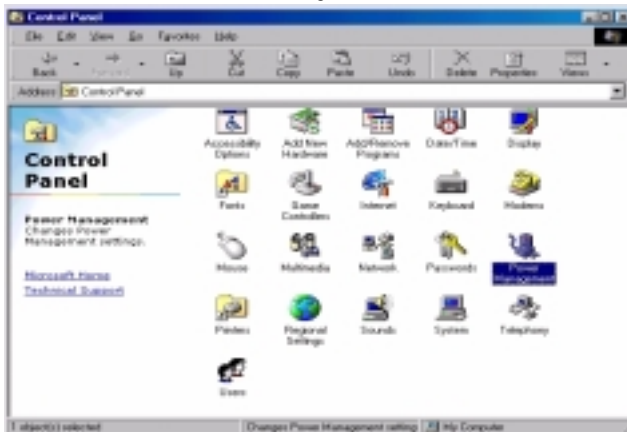

C. Select the "Advanced" tab and "Standby" mode in Power Buttons.

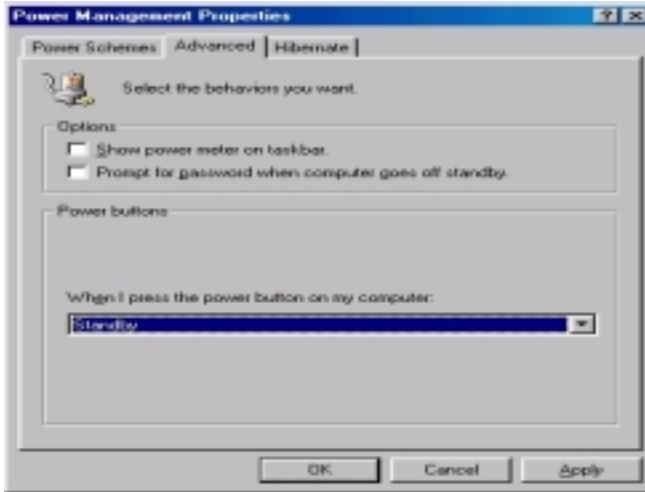

D. Restart your computer to complete setup.

Now when you want to enter STR sleep mode, just momentarily press the "Power on" button..

A.4 How to recover from the STR sleep mode?

There are seven ways to "wake up" the system:

1. Press the "Power On" button.
2. Use the "PS/2 Keyboard Power On" function.
3. Use the "PS/2 Mouse Power On" function.
4. Use the "Resume by Alarm" function.
5. Use the "Modem Ring On" function.
6. Use the "Wake On LAN" function.
7. Use the "USB Device Wake Up" function.

A.5 Notices :

1. In order for STR to function properly, the hardware devices, such as AGP, Ethernet card, etc., and related drivers must be compliant with ACPI specification.
2. ATX power supply must comply with the ATX 12V Power 1.1 specification (1.0 amps of 5V Stand-By current is minimum requirement, 2.0 amps was preferred).
3. Jumper JP12 is provided to connect to the STR LED in your system chassis. [Some chassis may not provide this feature.] The STR LED will be illuminated when your system is in STR sleep mode.

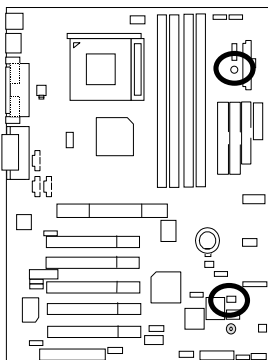

RIMM LED

STR LED Connector External



1

Dual BIOS Introduction (Optional)

A. What is Dual BIOS Technology?

Dual BIOS means that there are two system BIOS (ROM) on the motherboard, one is the Main BIOS and the other is Backup BIOS. Under normal circumstances, the system boots and works from the Main BIOS. If the Main BIOS is corrupted or damaged, the Backup BIOS can take over when the system is powers on. This means that your PC will still be able to run stably as if nothing has happened in your BIOS.

B. How to use Dual BIOS?

a. Boot Screen

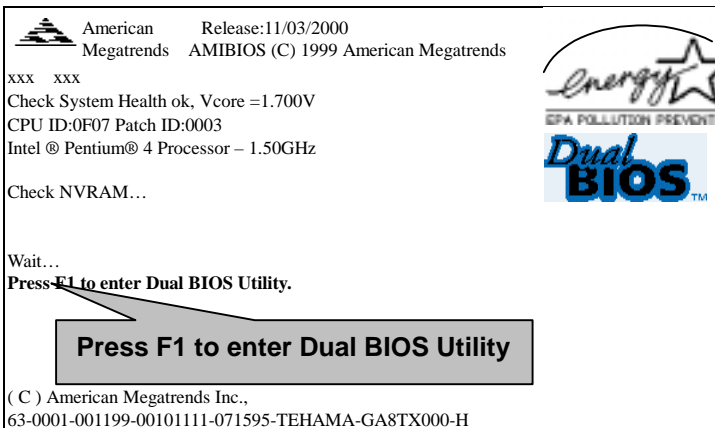

b. AMI Dual BIOS Flash ROM Programming Utility

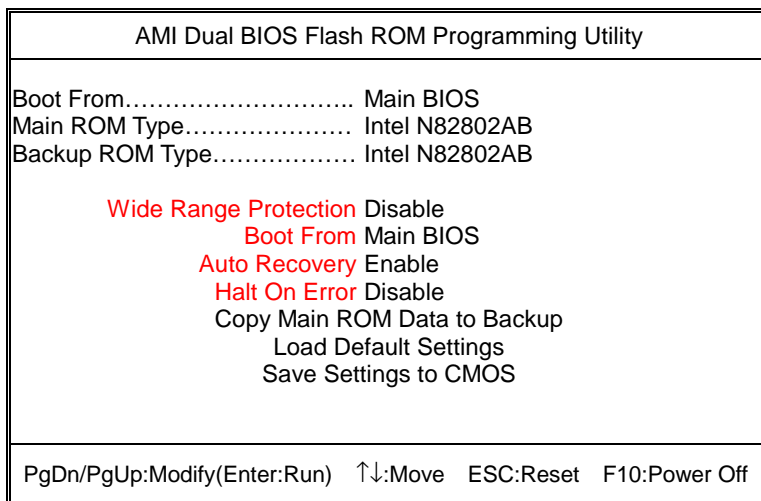

c. Dual BIOS Item explanation:

BIOS will auto detect:

Boot From : Main BIOS

Main ROM Type : Intel N82802AB

Backup ROM Type : Intel N82802AB

Wide Range Protection: Disable(Default), Enable

Status 1:

If the Wide Range Protection is set to "Enable", and a failure (ex. Update ESCD failure, checksum error or reset...) occurs in the Main BIOS just after the power is on (before the BIOS is loaded), the PC will boot from Backup BIOS automatically.

Status 2:

If the ROM BIOS on peripherals cards(ex. SCSI Cards, LAN Cards,..) emits signals to request restart of the system after the user make any alteration on it, the boot up BIOS will not be changed to the Backup BIOS.

Boot From : Main BIOS (Default), Backup BIOS

Status 1:

The user can set to boot from main BIOS or Backup BIOS.

Auto Recovery : Enabled(Default), Disabled

When one of the Main BIOS or Backup BIOS occurs checksum failure, the working BIOS will automatically recover the BIOS of checksum failure.

(In the Power Management Setup of the BIOS Setting, if ACPI Suspend Type is set to Suspend to RAM, the Auto Recovery will be set to Enable automatically.)

(If you want to enter the BIOS setting, please press "Del" key when the boot screen appears.)

Halt On Error : Disable(Default), Enable

If the BIOS occurs a checksum error or the Main BIOS occurs a WIDE RANGE PROTECTION error and Halt On BIOS Defects set to Enable, the PC will show messages on the boot screen, and the system will pause and wait for the user's instruction.

If Auto Recovery :**Disable**, it will show *<or the other key to continue.>*

If Auto Recovery :**Enable**, it will show *<or the other key to Auto Recover.>*

Copy Main ROM Data to Backup

Backup message:

Are you sure to copy BIOS?

[Enter] to continue or [Esc] to abort ...

The means that the Main BIOS works normally and could automatically recover the Backup BIOS. Or the means that the Backup BIOS works normally and could automatically recover the Main BIOS.

(This auto recovery utility is set by system automatically and can't be changed by user.)



DualBIOS™ Technology FAQ

GIGABYTE Technology is pleased to introduce DualBIOS technology, a hot spare for your system BIOS. This newest "Value-added" feature, in a long series of innovations from GIGABYTE, is available on GA-8TX motherboard. Future GIGABYTE motherboards will also incorporate this innovation.

What's DualBIOS™?

On GIGABYTE motherboards with DualBIOS there are physically two BIOS chips. For simplicity we'll call one your "Main BIOS" and the other is your "Backup" BIOS (your "hot spare"). If your Main BIOS fails, the Backup BIOS almost automatically takes over on your next system boot. Almost automatically and with virtually zero down time! Whether the problem is a failure in flashing your BIOS or a virus or a catastrophic failure of the Main BIOS chip, the result is the same - the Backup BIOS backs you up, almost automatically.

I. Q: What is DualBIOS™ technology?

Answer:

DualBIOS technology is a patented technology from Giga-Byte Technology. The concept of this technology is based on the redundancy and fault tolerance theory. DualBIOS™ technology simply means there are two system BIOSes (ROM) integrated onto the motherboard. One is a main BIOS, and the other is a backup BIOS. The mainboard will operate normally with the main BIOS, however, if the main BIOS is corrupt or damaged for various reasons, the backup BIOS will be automatically used when the system powered-On. Your PC will operate as before the main BIOS was damaged, and is completely transparent to the user.

II. Q: Why does anyone need a motherboard with DualBIOS™ technology?

Answer:

In today's systems there are more and more BIOS failures. The most common reasons are virus attacks, BIOS upgrade failures, and/or deterioration of the BIOS (ROM) chip itself.

1. New computer viruses are being found that attack and destroy the system BIOS. They may corrupt your BIOS code, causing your PC to be unstable or even not boot normally.
2. BIOS data will be corrupted if a power loss/surge occurs, or if a user resets the system, or if the power button is pressed during the process of performing a system BIOS upgrade.
3. If a user mistakenly updates their mainboard with the incorrect BIOS file, then the system may not be able to boot correctly. This may cause the PC system hang in operation or during boot.
4. A flash ROM's life cycle is limited according to electronic characteristics. The modern PC utilizes the Plug and Play BIOS, and is updated regularly. If a user changes peripherals often, there is a slight chance of damage to the flash ROM.

With Giga-Byte Technology's patented DualBIOS™ technology you can reduce the possibility of hangs during system boot up, and/or loss BIOS data due to above reasons. This new technology will eliminate valuable system down time and costly repair bills cause by BIOS failures.

III. Q: How does DualBIOS™ technology work?

Answer:

1. DualBIOS™ technology provides a wide range of protection during the boot up procedure. It protects your BIOS during system POST, ESCD update, and even all the way to PNP detection/assignment.
2. DualBIOS™ provides automatic recovery for the BIOS. When the first BIOS used during boot up does not complete or if a BIOS checksum error occurs, boot-up is still possible. In the DualBIOS™ utility, the "Auto Recovery" option will guarantee that if either the main BIOS or backup BIOS is corrupted, the DualBIOS™ technology will use the good BIOS and correct the wrong BIOS automatically.
3. DualBIOS™ provides manual recovery for the BIOS. DualBIOS™ technology contains a built-in flash utility, which can flash your system BIOS from backup to main and/or visa versa. There is no need for an OS-dependent flash utility program.
4. DualBIOS™ contains a one-way flash utility. The built-in one-way flash utility will ensure that the corrupt BIOS is not mistaken as the good BIOS during recovery and that the correct BIOS (main vs. backup) will be flashed. This will prevent the good BIOS from being flashed.

IV. Q: Who Needs DualBIOS™ technology?

Answer:

1. Every user should have DualBIOS™ technology due to the advancement of computer viruses.

Everyday, there are new BIOS-type viruses discovered that will destroy your system BIOS. Most commercial products on the market do not have solutions to guard against this type of virus intrusion. The DualBIOS™ technology will provide a state-of-the-art solution to protect your PC:

Case I.) Vicious computer viruses may wipe out your entire system BIOS. With a conventional single system BIOS PC, the PC will not be functional until it is sent for repairs.

Case II.) If the "Auto Recovery" option is enabled in the DualBIOS™ utility, and if a virus corrupts your system BIOS, the backup BIOS will automatically reboot the system and correct the main BIOS.

Case III.) A user may override booting from the main system BIOS. The DualBIOS™ utility may be entered to manually change the boot sequence to boot from the backup BIOS.

2. During or after a BIOS upgrade, if DualBIOS™ detects that the main BIOS is corrupt, the backup BIOS will take over the boot-up process automatically. Moreover, it will verify the main and backup BIOS checksums when booting-up. DualBIOS™ technology examines the checksum of the main and backup BIOS while the system is powered on to guarantee your BIOS operates properly.
3. Power Users will have the advantage of having two BIOS versions on their mainboard. The benefit is being able to select either version BIOS to suit the performance system needs.
4. Flexibility for high-end desktop PCs and workstation/servers. In the DualBIOS™ utility, the option can be set, "Halt On When BIOS Defects," to be enabled to halt your system with a warning message that the main BIOS has been corrupted. Most workstation/servers require constant operation to guarantee services have not been interrupted. In this situation, the "Halt On When BIOS Defects" message may be disabled to avoid system pauses during normal booting.

Four Speaker & SPDIF Introduction (Optional)

Four Speaker Introduction

A. What is Four Speaker?

The Creative CT5880 audio chip can support up to 4 speaker output. If you select “Four speaker out”, Line In will be reconfigured as another line out to support a second pair of speakers.

B. How to use Four Speaker?

Microsoft Windows 98 Second Edition setup procedure:

- a. Click the audio icon along the task bar and select “Configure 3D Audio”

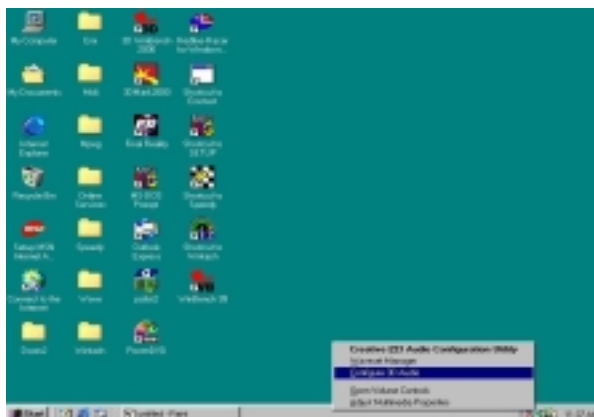

- b. Select two speaker (Default)



c. Select "Four speaker" item.



Microsoft Windows Me setup procedure:

a. Go to "Control Panel"

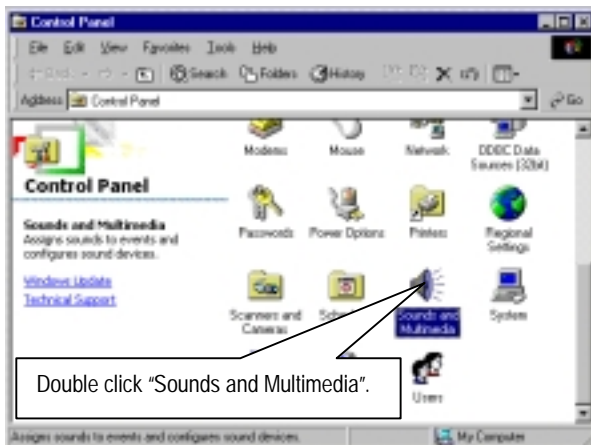

b. Select "Audio" Page, and click "Advanced" button.

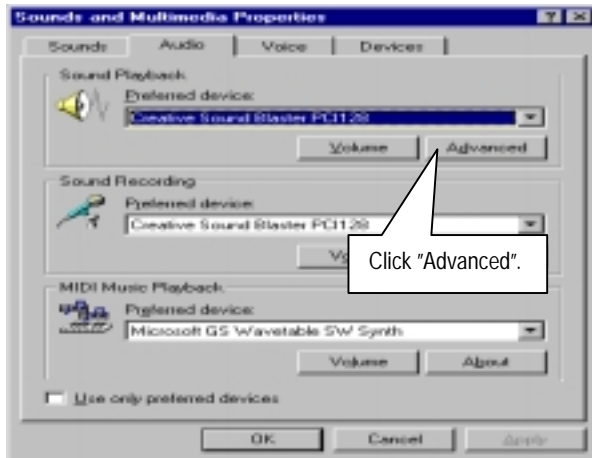

c. Select "Quadraphonic Speakers" and click ok.



C. Four Speaker Application

The four speaker function will only be supported in application softwares that use Microsoft DirectX and Creative EAX, for example, the game titles, software DVD player and MP3 player.

SPDIF Introduction

A. What is SPDIF?

The SPDIF output is capable of providing digital audio to external speakers or compressed AC3 data to an external Dolby digital decoder.

B. How to use SPDIF?

a. Click your mouse right button in "My Computer" and select the "Properties" item.

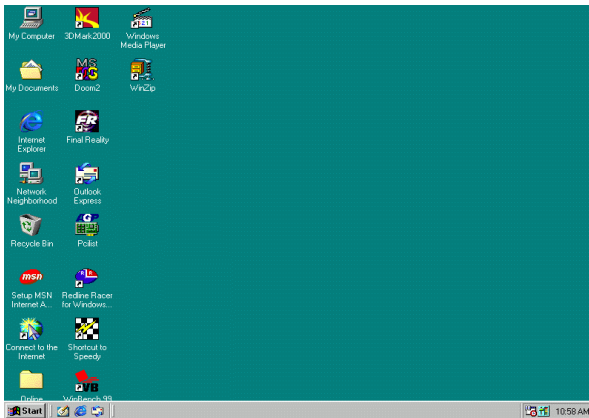

b. Click "Device Manager" item.

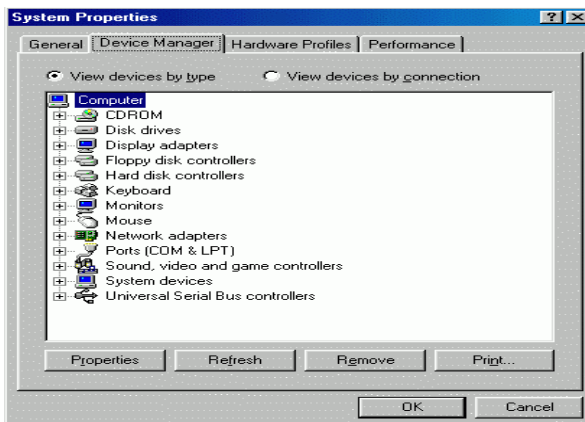

8TX Motherboard

- c. Click “Sound, video and game controllers” item and select the “Creative Sound Blaster PCI128” item.

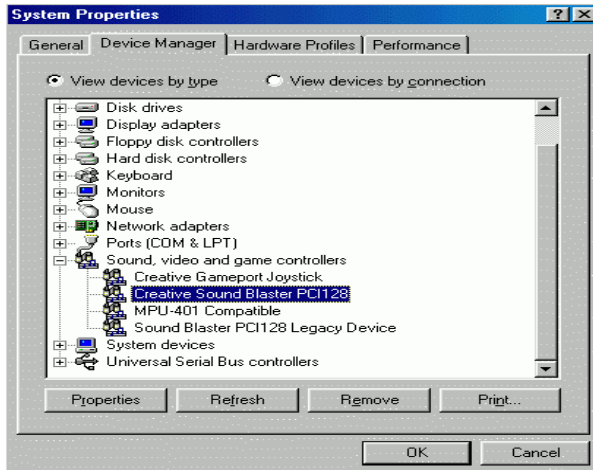

- d. Click “Settings” item and select the “Output Mode” item.

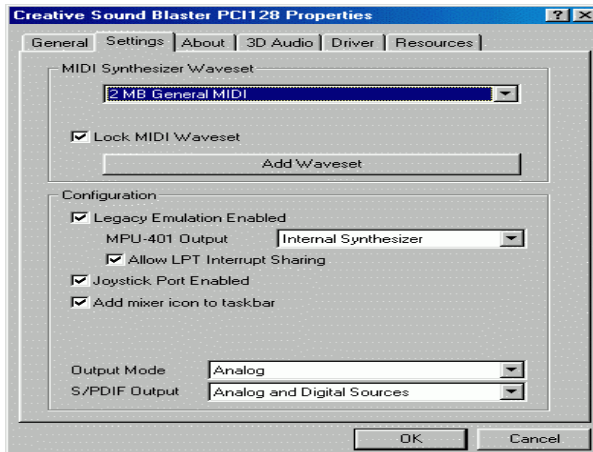

e. Click "Digital" item, Line Out will be reconfigure to SPDIF Out.

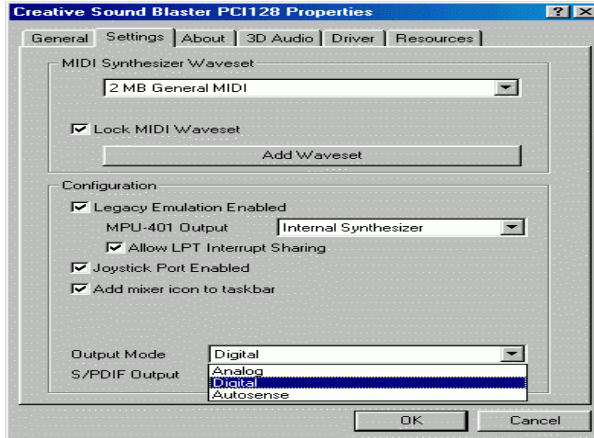

f. Recommend you to select "Autosense", It will automatically detect the type (mono or stereo) of the audio connector that you plug into Line Out audio jack, then configure Line Out to either SPDIF or Speaker accordingly.

@ BIOS™ Introduction (Optional)

Gigabyte announces @ BIOS Windows BIOS live update utility



Have you ever updated BIOS by yourself? Or like many other people, you just know what BIOS is, but always hesitate to update it? Because you think updating newest BIOS is unnecessary and actually you don't know how to update it.

Maybe not like others, you are very experienced in BIOS updating and spend quite a lot of time to do it. But of course you don't like to do it too much. First, download different BIOS from website and then switch the operating system to DOS mode. Secondly, use different flash utility to update BIOS. The above process is not a interesting job. Besides, always be carefully to store the BIOS source code correctly in your disks as if you update the wrong BIOS, it will be a nightmare.

Certainly, you wonder why motherboard vendors could not just do something right to save your time and effort and save you from the lousy BIOS updating work? Here it comes! Now Gigabyte announces @BIOS--the first Windows BIOS live update utility. This is a smart BIOS update software. It could help you to download the BIOS from internet and update it. Not like the other BIOS update software, it's a Windows utility. With the help of "@BIOS", BIOS updating is no more than a click.

Besides, no matter which mainboard you are using, if it's a Gigabyte's product*, @BIOS help you to maintain the BIOS. This utility could detect your correct mainboard model and help you to choose the BIOS accordingly. It then downloads the BIOS from the nearest Gigabyte ftp site automatically. There are several different choices; you could use "Internet Update" to download and update your BIOS directly. Or you may want to keep a backup for your current BIOS, just choose "Save Current BIOS" to save it first. You make a wise choice to use Gigabyte, and @BIOS update your BIOS smartly. You are now worry free from updating wrong BIOS, and capable to maintain and manage your BIOS easily. Again, Gigabyte's innovative product erects a milestone in mainboard industries.

For such a wonderful software, how much it costs? Impossible! It's free! Now, if you buy a Gigabyte's motherboard, you could find this amazing software in the attached driver CD. But please remember, connected to internet at first, then you could have a internet BIOS update from your Gigabyte @BIOS.

Easy TuneIII™ Introduction (Optional)

Gigabyte announces *EasyTuneIII* Windows overdrive utility



“Overdrive” might be one of the most common issues in computer field. But have many users ever tried it? The answer is probably “no”. Because “overdrive” is thought to be very difficult and includes a lot of technical know-how, sometimes “overdrive” is

even considered as special skills found only in some enthusiasts.

But as to the experts in “overdrive”, what’s the truth? They may spend quite a lot of time and money to study, try and use many different hardware and software tools to do “overdrive”. And even with these technologies, they still learn that it’s quite a risk because the safety and stability of an “overdrive” system is unknown.

Now everything is different because of a Windows overdrive utility EasyTuneIII--announced by Gigabyte. This utility has totally changed the gaming rule of “overdrive”. This is the first overdrive utility suitable for both normal and power users. Users can choose either “Easy Mode” or “Advanced Mode” to run “overdrive” at their convenience. For users who choose “Easy Mode”, they just need to click “Auto Optimize” to have auto and immediate CPU overclocking. This software will then overdrive CPU speed automatically with the result being shown in the control panel. If someone prefers to “overdrive” by oneself, there is also another choice. Click “Advanced Mode” to enjoy “sport drive” class overclocking. In “Advanced Mode”, one can change the system bus speed in small increments to get ultimate system performance. And no matter which mainboard is used, if it’s a Gigabyte’s product*, EasyTuneIII helps to perform the best of system.

Besides, different from other traditional over-clocking methods, EasyTuneIII doesn’t require users to change neither BIOS nor hardware switch/ jumper setting; on the other hand, they can do “overdrive” at only one click. Therefore, this is a safer way for “overdrive” as nothing is changed on software or hardware. If user runs EasyTuneIII over system’s limitation, the biggest lost is only to restart the computer again and the side effect is then well controlled. Moreover, if one well-performed system speed been tested in EasyTuneIII, user can “Save” this bus speed and “Load” it in next time. Obviously, Gigabyte EasyTuneIII has already turned the “overdrive” technology toward to a newer generation.

This wonderful software is now free bundled in Gigabyte motherboard attached driver CD. Users may make a test drive of “EasyTuneIII” to find out more amazing features by themselves.

For further technical information, please link to: <http://www.gigabyte.com.tw>

※ **Note: If your IUCD version is 1.6 or below, please visit our website and download the latest EasyTuneIII™ version.**

Page Index for BIOS Setup	Page
The Main Menu	P.60
Standard CMOS Setup	P.62
BIOS Features Setup	P.65
Chipset Features Setup	P.67
Power Management Setup	P.69
PNP/ PCI Configuration	P.72
Load BIOS Defaults	P.73
Load Setup Defaults	P.74
Integrated Peripherals	P.75
Hardware Monitor Setup	P.79
Supervisor / User Password	P.81
IDE HDD Auto Detection	P.82
Save & Exit Setup	P.83
Exit Without Saving	P.84

BIOS Setup

BIOS Setup is an overview of the BIOS Setup Interface. The interface allows users to modify the basic system configuration, which is stored in battery-backed CMOS RAM so that it retains the Setup information can be retained when the power is turned off.

ENTERING SETUP

Power ON the computer and press immediately will allow you to enter Setup. If unsuccessful, you can restart the system and try again by pressing the "RESET" button on the system case. You may also restart by simultaneously pressing <Ctrl> – <Alt>– keys.

CONTROL KEYS

<↑>	Move to previous item
<↓>	Move to next item
<←>	Move to the item in the left hand
<→>	Move to the item in the right hand
<Esc>	Main Menu - Quit and not save changes into CMOS Status Page Setup Menu and Option Page Setup Menu - Exit current page and return to Main Menu
<+/ PgUp>	Increase the numeric value or make changes
<-/ PgDn>	Decrease the numeric value or make changes
<F1>	General help, only for Status Page Setup Menu and Option Page Setup Menu
<F2>	Reserved
<F3>	Reserved
<F4>	Reserved
<F5>	Restore the previous CMOS value from CMOS, only for Option Page Setup Menu
<F6>	Load the default CMOS value from BIOS default table, only for Option Page Setup Menu
<F7>	Load the Setup Defaults
<F8>	Reserved
<F9>	Reserved
<F10>	Save all the CMOS changes, only for Main Menu

GETTING HELP

Main Menu

The on-line description of the highlighted setup function is displayed at the bottom of the screen.

Status Page Setup Menu / Option Page Setup Menu

Press F1 to pop up a small help window that describes the appropriate keys to use and the possible selections for the highlighted item. To exit the Help Window press <Esc>.

The Main Menu

Once you enter AMI BIOS CMOS Setup Utility, the Main Menu (Figure 1) will appear on the screen. The Main Menu allows you to select from nine setup functions and two exit choices. Use arrow keys to select among the items and press <Enter> to accept or enter the sub-menu.

AMIBIOS SIMPLE SETUP UTILITY – VERSION 1.24a (C) 1999 American Megatrends, Inc. All Rights Reserved	
STANDARD CMOS SETUP	INTEGRATED PERIPHERALS
BIOS FEATURES SETUP	HARDWARE MONITOR SETUP
CHIPSET FEATURES SETUP	SUPERVISOR PASSWORD
POWER MANAGEMENT SETUP	USER PASSWORD
PNP / PCI CONFIGURATION	IDE HDD AUTO DETECTION
LOAD BIOS DEFAULTS	SAVE & EXIT SETUP
LOAD SETUP DEFAULTS	EXIT WITHOUT SAVING
ESC: Quit ↑↓→← : Select Item (Shift)F2 : Change Color F5: Old Values F6: Load BIOS Defaults F7: Load Setup Defaults F10: Save & Exit	
Time, Date , Hard Disk Type...	

Figure 1: Main Menu

- **Standard CMOS Setup**

This setup page includes all the adjustable items in standard compatible BIOS.

- **BIOS Features Setup**

This setup page includes all the adjustable items of Award special enhanced features.

- **Chipset Features Setup**

This setup page includes all the adjustable items of chipset special features.

- **Power Management Setup**

This setup page includes all the adjustable items of Green function features.

- **PnP/PCI Configurations**

This setup page includes all the adjustable configurations of PCI & PnP ISA resources.

- **Load BIOS Defaults**

Load BIOS Defaults option loads preset system parameter values to set the system in its most stable configurations.

- **Load Setup Defaults**

Load Setup Defaults option loads preset system parameter values to set the system in its highest performance configurations.

- **Integrated Peripherals**

This setup page includes all onboard peripherals.

- **Hardware Monitor Setup**

This setup page is auto detect fan and temperature status.

- **Set Supervisor Password**

Set Change or disable password. It allows you to limit access to the system and/or BIOS setup.

- **Set User Password**

Set Change or disable password. It allows you to limit access to the system.

- **IDE HDD auto detection**

Automatically configure hard disk parameters.

- **Save & Exit Setup**

Save CMOS value settings to CMOS and exit setup.

- **Exit Without Saving**

Abandon all CMOS value changes and exit setup.

Standard CMOS Setup

The items in Standard CMOS Setup Menu (Figure 2) are divided into 10 categories. Each category includes none, one or more than one setup items. Use the arrows to highlight the item and then use the <PgUp> or <PgDn> keys to select the value in each item.

AMIBIOS SETUP – STANDARD CMOS SETUP	
(C) 1999 American Megatrends, Inc. All Rights Reserved	
Date (mm/dd/yyyy) : Thu Feb 17, 2000	
Time (hh/mm/ss) : 14:44:35	
	TYPE SIZE CYLS HEAD PRECOMP LANDZ SECTOR MODE
Pri Master : Auto	
Pri Slave : Auto	
Sec Master : Auto	
Sec Slave : Auto	
Floppy Drive A : 1.44 MB 3½	Base Memory : 640 Kb
Floppy Drive B : Not Installed	Other Memory : 384 Kb
	Extended Memory : 63 Mb
Boot Sector Virus Protection : Disabled	Total Memory : 64 Mb
Month : Jan – Dec	ESC : Exit
Day : 01– 31	↑↓ : Select Item
Year : 1990 – 2099	PU / PD / + / - : Modify
	(Shift) F2 : Color

Figure 2: Standard CMOS Setup

- **Date**

The date format is <Week>, <Month> <Day> <Year>.

Week	The week, from Sun to Sat, determined by the BIOS and is display-only
Month	The month, Jan. Through Dec.
Day	The day, from 1 to 31 (or the maximum allowed in the month)
Year	The year, from 1990 through 2099

- **Time**

The times format in <hour> <minute> <second>. The time is calculated base on the 24-hour military-time clock. For example, 1 p.m. is 13:00:00.

- **Primary Master / Slave , Secondary Master / Slave**

The category identifies the type of hard disk from drive C to F that has been installed in the computer. There are two settings: Auto, and Manual. Manual: HDD type is user-definable; Auto will automatically detect HDD type.

Note that the specifications of your drive must match with the drive table. The hard disk will not work properly if you enter improper information for this category.

If you select User Type, related information will be asked to enter to the following items. Enter the information directly from the keyboard and press <Enter>. Such information should be provided in the documentation from your hard disk vendor or the system manufacturer.

CYLS.	Number of cylinders
HEADS	number of heads
PRECOMP	write precomp
LANDZONE	Landing zone
SECTORS	number of sectors

If a hard disk has not been installed select NONE and press <Enter>.

- **Floppy Drive A / Drive B**

The category identifies the type of floppy disk drive A or drive B that has been installed in the computer.

None	No floppy drive installed.
360K, 5.25 in.	5.25 inch PC-type standard drive; 360K byte capacity.
1.2M, 5.25 in.	5.25 inch AT-type high-density drive; 1.2M byte capacity (3.5 inch when 3 Mode is Enabled).
720K, 3.5 in.	3.5 inch double-sided drive; 720K byte capacity.
1.44M, 3.5 in.	3.5 inch double-sided drive; 1.44M byte capacity.
2.88M, 3.5 in.	3.5 inch double-sided drive; 2.88M byte capacity.

- **Boot Sector Virus Protection**

If it is set to enable, the category will flash on the screen when there is any attempt to write to the boot sector or partition table of the hard disk drive. The system will halt and the following error message will appear in the mean time. You can run anti-virus program to locate the problem.

Enabled	Activate automatically when the system boots up causing a warning message to appear when anything attempts to access the boot sector or hard disk partition table
Disabled	No warning message to appear when anything attempts to access the boot sector or hard disk partition table (Default Value)

- **Memory**

The category is display-only which is determined by POST (Power On Self Test) of the BIOS.

Base Memory

The POST of the BIOS will determine the amount of base (or conventional) memory installed in the system.

The value of the base memory is typically 512 K for systems with 512 K memory installed on the motherboard, or 640 K for systems with 640 K or more memory installed on the motherboard.

Other Memory

This refers to the memory located in the 640 K to 1024 K address space. This is memory that can be used for different applications.

DOS uses this area to load device drivers to keep as much base memory free for application programs. Most use for this area is Shadow RAM.

Extended Memory

The BIOS determines how much extended memory is present during the POST. This is the amount of memory located above 1 MB in the CPU's memory address map.

BIOS Features Setup

AMBIOS SETUP – BIOS FEATURES SETUP	
(C) 1999 American Megatrends, Inc. All Rights Reserved	
1st Boot Device	: Floppy
2nd Boot Device	: IDE-0
3rd Boot Device	: CDROM
Floppy Drive Seek	: Disabled
BootUp Num-Lock	: On
Password Check	: Setup
S.M.A.R.T. for Hard Disks	: Disabled
ESC: Quit ↑↓→←: Select Item F1 : Help PU/PD+/-: Modify F5 :Old Values(Shift)F2:Color F6 : Load BIOS Defaults F7 : Load Setup Defaults	

Figure 3: BIOS Features Setup

- **1st / 2nd / 3rd Boot Device**

Floppy	Set your boot device priority to Floppy.
LS/ ZIP A:	Set your boot device priority to LS/ ZIP A:.
CDROM	Set your boot device priority to CDROM.
SCSI	Set your boot device priority to SCSI.
NETWORK	Set your boot device priority to NETWORK.
IDE-0-IDE-3	Set your boot device priority to IDE-0-IDE-3.
Disabled	Disable this function.
ATAPI ZIP C:	Set your boot device priority to ATAPI ZIP C:.

- **Floppy Drive Seek**

During POST, BIOS will determine if the floppy disk drive installed is 40 or 80 tracks. 360 type is 40 tracks while 720, 1.2 and 1.44 are all 80 tracks.

Enabled	BIOS searches for floppy disk drive to determine if it is 40 or 80 tracks. Note that BIOS can't differentiate between from 720, 1.2 or 1.44 drive type as they are all 80 tracks.
Disabled	BIOS will not search for the type of floppy disk drive by track number. Note that there will not be any warning message if the drive installed is 360. (Default Value)

- **Boot Up Num-Lock**

On	Keypad is number keys. (Default Value)
Off	Keypad is arrow keys.

- **Password Check**

 Please refer to the detail on P.81

Setup	The user must enter correct password in order to access BIOS setup utility. (Default Value)
Always	The user must enter correct password in order to access the system and/or BIOS Setup.

- **S.M.A.R.T. for Hard Disks**

Enabled	Enabled S.M.A.R.T. Feature for Hard Disks.
Disabled	Disabled S.M.A.R.T. Feature for Hard Disks (Default Value)

Chipset Features Setup

 We would not suggest you change the chipset default setting unless you really need it.

AMIBIOS SETUP – CHIPSET FEATURES SETUP	
(C) 1999 American Megatrends, Inc. All Rights Reserved	
CPU Frequency Ratio	:8:1
RDRAM Bus Frequency	:Auto
Over RIMM Voltage	:Disabled
Memory ECC Mode	:Disabled
Memory Hole	:Disabled
Graphics Aperture Size	:64MB
Delayed Transaction	:Disabled
DMA Collection Buffer	:Disabled
ESC: Quit ↑↓→←: Select Item F1 : Help PU/PD+/-/: Modify F5 :Old Values(Shift)F2:Color F6 : Load BIOS Defaults F7 : Load Setup Defaults	

Figure 4: Chipset Features Setup

- CPU Frequency Ratio**

8:1~, 22:1, 23:1 (Default Value: 8:1)

- RDRAM Bus Frequency**

Auto	Set RDRAM Bus Frequency automatically (Default Value)
400MHz	Set RDRAM Bus Frequency to 400MHz. (If the current RDRAM is supported)
300MHz	Set RDRAM Bus Frequency to 300MHz. (If the current RDRAM is supported)

- Over RIMM Voltage**

Enabled	RIMM voltage will be higher then the normal case.
Disabled	Disable this function. (Default Value)

- Memory ECC Mode**

Enabled	Enable Memory Data Check ECC Mode.
Disabled	Disable this function. (Default Value)

- **Memory Hole**

Disabled	Normal Setting. (Default Value)
15MB~16MB	Set Address=15~16MB relocate to ISA BUS.

- **Graphics Aperture Size**

4 MB	Display Graphics Aperture Size is 4MB.
8 MB	Display Graphics Aperture Size is 8MB.
16 MB	Display Graphics Aperture Size is 16MB.
32 MB	Display Graphics Aperture Size is 32MB.
64 MB	Display Graphics Aperture Size is 64MB. (Default Value)
128 MB	Display Graphics Aperture Size is 128MB.
256 MB	Display Graphics Aperture Size is 256MB.

- **Delayed Transaction**

Enabled	Enable PCI 2.1 features including release and delayed transaction for the chipset.
Disabled	Disable this function. (Default Value)

- **DMA Collection Buffer**

Enabled	Enable DMA collection buffer for LPC I/F and PC/PCI DMA.
Disabled	Disable this function. (Default Value)

Power Management Setup

AMIBIOS SETUP – POWER MANAGEMENT SETUP (C) 1999 American Megatrends, Inc. All Rights Reserved			
ACPI Sleep Type	: S1/POS	PIRQ[B] Active	: Ignore
USB Dev Wakeup From S3	: Disabled	PIRQ[C] IRQ Active	: Ignore
Suspend Time Out (Minute)	: Disabled	PIRQ[D] IRQ Active	: Ignore
Throttle Slow Clock Ratio	: 50.0%		
Soft-Off by Power Button	: Instant Off		
System After AC Back	: Off		
ModemRingOn/WakeOnLan	: Enabled		
PME Event Wake Up	: Enabled		
Resume by RTC Alarm	: Disabled		
RTC Alarm Date	: Event Day		
RTC Alarm Hour	: 00		
RTC Alarm Minute	: 00		
RTC Alarm Second	: 00		
KB & PS/2 Mouse Access	: Monitor		
FDC/LPT/COM Ports Access	: Monitor		
Pri. Master IDE Access	: Monitor	ESC: Quit	↑↓→←: Select Item
Pri. Slave IDE Access	: Ignore	F1 : Help	PU/PD+/- : Modify
Sec. Master IDE Access	: Monitor	F5 :Old Values(Shift)F2:Color	
Sec. Slave IDE Access	: Ignore	F6 : Load BIOS Defaults	
PIRQ[A] Active	: Ignore	F7 : Load Setup Defaults	

Figure 5: Power Management Setup

- **ACPI Sleep Type**

S1/POS	Set ACPI Sleep Type to S1/POS (Power On Suspend). (Default value)
S3/STR	Set ACPI Sleep Type to S3/STR (Suspend To RAM).

- **USB Dev Wakeup From S3**

USB Device Wakeup From S3 can be set when ACPI Sleep Type set to S3/STR.

Enabled	Enable USB Device Wakeup From S3.
Disabled	Disable USB Device Wakeup From S3. (Default value)

- **Suspend Time Out (Minute)**

 System enters suspend power state when the length of period selected by this optional has expired.

Disabled	Disable the timer to enter suspend mode. (Default Value)
30Sec ~ 1Hour	Set the timer to enter suspend mode.

- **Throttle Slow Clock Ratio**

This option determines the duty cycle of the throttling when thermal override condition occurs.

12.5%/25.0%/37.5%/50.0% (Default Value) /62.5%/75.0%/87.5%

- **Soft-off by Power Button**

Instant off	The user press the power button once, he can turn off the system. (Default Value)
Suspend	The user press the power button once, then he can enter suspend mode.

- **System after AC Back**

Off	When AC-power back to the system, the system will be in "Off" state. (Default Value)
On	When AC-power back to the system, the system will be in "On" state.
Last State	When AC-power back to the system, the system will return to the Last state before AC-power off.

- **ModemRingOn / WakeOnLan**

Disabled	Disable Modem Ring On / Wake On LAN function.
Enabled	The modem ring / LAN wake up will bring the system out of soft-off or suspend state if this option is set "Enabled". (Default Value)

- **PME Event Wake up**

Disabled	Disable PME event wake up function.
Enabled	The PME event wake up will bring the system out of soft-off or suspend state if this option is set "Enabled". (Default Value)

- **Resume by RTC Alarm**

You can set "Resume by RTC Alarm " item to enabled and key in Data/time to power on system.

Disabled	Disable this function. (Default Value)
Enabled	Enable alarm function to POWER ON system.

If Resume by RTC Alarm is Enabled.

RTC Alarm Date :	Every Day,1~31
RTC Alarm Hour:	0~23
RTC Alarm Minute :	0~59
RTC Alarm Second :	0~59

- **K/B & PS/2 Mouse Access**

Monitor	Monitor Keyboard & PS/2 Mouse Access. (Default Value)
Ignore	Ignore Keyboard & PS/2 Mouse Access.

- **FDC/LPT/COM Ports Access**

Monitor	Monitor FDC/LPT/COM Ports Access. (Default Value)
Ignore	Ignore FDC/LPT/COM Ports Access.

- **Pri. Master IDE Access**

Monitor	Monitor Primary Master IDE Access. (Default Value)
Ignore	Ignore Primary Master IDE Access.

- **Pri. slave IDE Access**

Monitor	Monitor Primary slave IDE Access.
Ignore	Ignore Primary slave IDE Access. (Default Value)

- **Sec. Master IDE Access**

Monitor	Monitor Secondary Master IDE Access. (Default Value)
Ignore	Ignore Secondary Master IDE Access.

- **Sec. slave IDE Access**

Monitor	Monitor Secondary slave IDE Access.
Ignore	Ignore Secondary slave IDE Access. (Default Value)

- **PIRQ[A] IRQ Active**

Monitor	Monitor PIRQ[A] IRQ Active.
Ignore	Ignore PIRQ[A] IRQ Active. (Default Value)

- **PIRQ[B] IRQ Active**

Monitor	Monitor PIRQ[B] IRQ Active.
Ignore	Ignore PIRQ[B] IRQ Active. (Default Value)

- **PIRQ[C] IRQ Active**

Monitor	Monitor PIRQ[C] IRQ Active.
Ignore	Ignore PIRQ[C] IRQ Active. (Default Value)

- **PIRQ[D] IRQ Active**

Monitor	Monitor PIRQ[D] IRQ Active.
Ignore	Ignore PIRQ[D] IRQ Active. (Default Value)

PNP/PCI Configuration

AMIBIOS SETUP – PNP / PCI CONFIGURATION	
(C) 1999 American Megatrends, Inc. All Rights Reserved	
Reset Configuration Data	: Disabled
VGA Boot From	: AGP
IRQ-3	: PCI/PnP
IRQ-4	: PCI/PnP
IRQ-5	: PCI/PnP
IRQ-7	: PCI/PnP
IRQ-9	: PCI/PnP
IRQ-10	: PCI/PnP
IRQ-11	: PCI/PnP
IRQ-14	: PCI/PnP
IRQ-15	: PCI/PnP
ESC: Quit ↑↓→←: Select Item F1 : Help PU/PD+/- : Modify F5 :Old Values(Shift)F2:Color F6 : Load BIOS Defaults F7 : Load Setup Defaults	

Figure 6: PNP/PCI Configuration

- **Reset Configuration Data**

Advising BIOS clear PnP configuration data for usable value.

Disabled	Disabled this function. (Default Value) .
Enabled	Reset PnP configuration data in order to re-initialize ESCD for PnP device.

- **VGA Boot From**

AGP	Set VGA Boot from AGP VGA Card. (Default Value)
PCI	Set VGA Boot from PCI VGA Card.

- **IRQ (3,4,5,7,9,10,11,14,15)**

ISA	The resource reserved for Legacy ISA device.
PCI/PnP	The resource can be assigned to PCI/ PnP device.

Load BIOS Defaults

AMIBIOS SIMPLE SETUP UTILITY-VERSION 1.24a (C) 1999 American Megatrends, Inc. All Rights Reserved	
STANDARD CMOS SETUP	INTEGRATED PERIPHERALS
BIOS FEATURES SETUP	HARDWARE MONITOR SETUP
CHIPSET FEATURES SETUP	SUPERVISOR PASSWORD
POWER MANAGEMENT SETUP	USER PASSWORD
PNP/PCI CONFIGURATION	LOAD BIOS Defaults (Y/N)?N
LOAD BIOS DEFAULTS	SAVE & EXIT SETUP
LOAD SETUP DEFAULTS	EXIT WITHOUT SAVING
ESC : Quit ↑↓→← : Select Item (Shift) F2 : Change Color F5 : Old Values F6 : Load BIOS Defaults F7: Load Setup Defaults F10: Save & Exit	
Load BIOS Defaults except Standard CMOS SETUP	

Figure 7: Load BIOS Defaults

- **Load BIOS Defaults**

BIOS defaults contain the most appropriate system parameter values of to configure the system to achieve maximum stability.

Load Setup Defaults

AMIBIOS SIMPLE SETUP UTILITY-VERSION 1.24a (C) 1999 American Megatrends, Inc. All Rights Reserved	
STANDARD CMOS SETUP	INTEGRATED PERIPHERALS
BIOS FEATURES SETUP	HARDWARE MONITOR SETUP
CHIPSET FEATURES SETUP	SUPERVISOR PASSWORD
POWER MANAGE	
PNP/PCI CONFIG	CTION
LOAD BIOS DEFAULTS	SAVE & EXIT SETUP
LOAD SETUP DEFAULTS	EXIT WITHOUT SAVING
ESC : Quit ↑↓→← : Select Item (Shift) F2 : Change Color F5 : Old Values F6 : Load BIOS Defaults F7: Load Setup Defaults F10: Save & Exit	
Load Setup Defaults except Standard CMOS SETUP	

Figure 8: Load Setup Defaults

- **Load SETUP Defaults**

Load Setup defaults contain the most appropriate system parameter values to configure the system to achieve maximum performance.

Integrated Peripherals

AMIBIOS SETUP – INTEGRATED PERIPHERALS			
(C) 1999 American Megatrends, Inc. All Rights Reserved			
OnBoard IDE	: Both	USB Legacy Support	: Disabled
OnBoard FDC	: Auto	AC97 Audio	: Auto
OnBoard Serial Port A	: Auto	AC97 Modem	: Auto
OnBoard Serial Port B	: Auto		
Serial Port B Mode	: Normal		
IR Duplex Mode	: Half Duplex		
OnBoard CIR Port	: Disabled		
CIR IRQ Select	: 10		
OnBoard Parallel Port	: Auto		
Parallel Port Mode	: ECP		
EPP Version	: N/A		
Parallel Port IRQ	: Auto		
Parallel Port DMA	: Auto		
◆ OnBoard Midi Port	: Disabled		
◆ Midi IRQ Select	: 9	ESC: Quit	↑↓→←: Select Item
◆ OnBoard Game Port	: Disabled	F1 : Help	PU/PD+/-/: Modify
Mouse PowerOn Function	: Disabled	F5 :Old Values(Shift)	F2:Color
Keyboard PowerOn Function	: Disabled	F6 : Load BIOS Defaults	
Specific Key for PowerOn	: N/A	F7 : Load Setup Defaults	
USB Controller	: Enabled		

Figure 9: Integrated Peripherals

- ◆ These three items will be shown when there is only AC'97 CODEC sound.

● OnBoard IDE

Disabled	Disable OnBoard IDE.
Both	Both Primary & Secondary IDE channel will be enabled. (Default Value) .
Primary	Only Primary IDE channel is enabled.
Secondary	Only Secondary IDE channel is enabled.

● OnBoard FDC

Disabled	Disable this function.
Enabled	Enable on board floppy disk controller.
Auto	Set the floppy disk controller automatically. (Default Value)

● OnBoard Serial Port A

Auto	BIOS will automatically setup the port A address. (Default Value)
3F8/COM1	Enable OnBoard Serial port A and address is 3F8.
2F8/COM2	Enable OnBoard Serial port A and address is 2F8.
3E8/COM3	Enable OnBoard Serial port A and address is 3E8.
2E8/COM4	Enable OnBoard Serial port A and address is 2E8.
Disabled	Disable OnBoard Serial port A.

● **OnBoard Serial Port B**

Auto	BIOS will automatically setup the port B address. (Default Value)
3F8/COM1	Enable OnBoard Serial port B and address is 3F8.
2F8/COM2	Enable OnBoard Serial port B and address is 2F8.
3E8/COM3	Enable OnBoard Serial port B and address is 3E8.
2E8/COM4	Enable OnBoard Serial port B and address is 2E8.
Disabled	Disable OnBoard Serial port B.

● **Serial Port B Mode**

(This item allows you to determine which Serial Port B Mode of onboard I/O chip)

Normal	Set onboard I/O chip Serial Port B to Normal Mode. (Default Value)
IrDA	Set onboard I/O chip Serial Port B to IrDA Mode.
ASKIR	Set onboard I/O chip Serial Port B to ASKIR Mode.

● **IR Duplex Mode**

Half Duplex	IR Function Duplex Half. (Default Value)
Full Duplex	IR Function Duplex Full.

● **OnBoard CIR port**

Disabled	Disable this function. (Default Value)
Enabled	Enable Onboard CIR port .

● **CIR IRQ Select**

IRQ 3 / 4 / 9 / 10 (Default Value) / 11
--

● **OnBoard Parallel port**

378	Set On Board LPT port and address to 378.
278	Set On Board LPT port and address to 278.
3BC	Set On Board LPT port and address to 3BC.
Auto	Set On Board LPT port Automatically. (Default Value).
Disabled	Disable this function.

- **Parallel Port Mode**

EPP	Using Parallel port as Enhanced Parallel Port.
ECP	Using Parallel port as Extended Capabilities Port. (Default Value)
Normal	Normal Operation.

- **EPP Version**

1.9	Compliant with EPP 1.9 version.
1.7	Compliant with EPP 1.7 version. (Default Value)

- **Parallel Port IRQ**

7	Set Parallel Port IRQ to 7.
5	Set Parallel Port IRQ to 5.
Auto	Set Parallel Port IRQ automatically. (Default Value)

- **Parallel Port DMA**

3	Set Parallel Port DMA to 3.
1	Set Parallel Port DMA to 1.
0	Set Parallel Port DMA to 0.
Auto	Set Parallel Port DMA automatically. (Default Value)

- **OnBoard Midi Port**

Disabled	Disabled onboard Midi Port.
300	Set onboard Midi Port to 300.
330	Set onboard Midi Port to 330. (Default Value)
292	Set onboard Midi Port to 292.
290	Set onboard Midi Port to 290.

- **Midi IRQ Select**

IRQ 5 / 7 / 9 (Default Value) / 10

- **OnBoard Game Port**

Disabled	Disabled OnBoard Game Port.
200	Set OnBoard Game Port to 200. (Default Value)
208	Set OnBoard Game Port to 208.

- **Mouse PowerOn Function**

Disabled	Disable this function. (Default Value)
Right -button	Click right-button to power on the system.
Left-button	Click Left-button to power on the system.

- **Keyboard Power On Function**

Disabled	Disable this function. (Default Value)
Specific key	Set password key to power on by keyboard.
Power Key	Set "Power key" to power on the system.

- **Specific Key for PowerOn**

N/A	Disable this function. (Default Value)
Password ←	Enter from 1 to 5 characters to set the Keyboard Power On Password.

- **USB Controller**

Enabled	Enable USB Controller.
Disabled	Disabled this function.

- **USB Legacy Support**

Enabled	Enable USB Legacy Support.
Disabled	Disabled this function. (Default Value)

- **AC'97 Audio**

Auto	Set AC'97 Audio automatically. (Default Value)
Disabled	Disabled this function.

- **AC'97 Modem**

Auto	Set AC'97 Modem automatically. (Default Value)
Disabled	Disabled this function.

Hardware Monitor Setup

AMIBIOS SETUP – HARDWARE MONITOR SETUP	
(C) 1999 American Megatrends, Inc. All Rights Reserved	
CPU Temp. Alarm	:Disabled
CPU Fan Fail Alarm	:No
Power Fan Fail Alarm	:No
System Fan Fail Alarm	:No
Reset Case Open Status	: No
Case Status	: Closed
Current CPU Temp.	: 35°C/ 95°F
Current System Temp.	: 33°C/ 91°F
Current CPU Fan Speed	: 5273 RPM
Current System Fan Speed	: 0 RPM
Current Power Fan Speed	: 0 RPM
CPU VID	: 1.700 V
Vcore	: +1.632V
Vcc18	: +1.840V
Vio	: +3.344V
+5.000V	: +5.080V
+12.000V	: +11.840V
-12.000V	: -11.885V
Battery	: +3.020V
+5V SB	: +4.972V
ESC: Quit ↑↓→←: Select Item	
F1 : Help PU/PD+/-/ : Modify	
F5 :Old Values(Shift)F2:Color	
F6 : Load BIOS Defaults	
F7 : Load Setup Defaults	

Figure 10: Hardware Monitor Setup

- CPU Temp. Alarm

60°C / 140°F	Monitor CPU Temp. at 60°C / 140°F.
70°C / 158°F	Monitor CPU Temp. at 70°C / 158°F.
80°C / 176°F	Monitor CPU Temp. at 80°C / 176°F.
90°C / 194°F	Monitor CPU Temp. at 90°C / 194°F.
Disabled	Disabled this function. (Default Value)

- Fan Fail Alarm

CPU / Power / System

No	Fan Fail Alarm Function Disabled. (Default Value)
Yes	Fan Fail Alarm Function Enabled.

- Reset Case Open Status

- Case Status

If the case is closed, "Case Status" will show "No".

If the case have been opened, "Case Status" will show "Yes".

If you want to reset "Case Status" value, set "Reset Case Open Status" to "Yes" and save CMOS, your computer will restart.

- **Current CPU Tempe.**

Detect CPU Temp. automatically.

- **Current System Tempe.**

Detect System Temp. automatically.

- **Current CPU FAN / System FAN / Power FAN Speed (RPM)**

Detect Fan speed status automatically.

- **Current CPU VID / Vcore / Vcc18 / Vio / $\pm 12V$ / +5V / Battery / +5VSB**

Detect system's voltage status automatically.

Supervisor / User Password

When you select this function, the following message will appear at the center of the screen to assist you in creating a password.

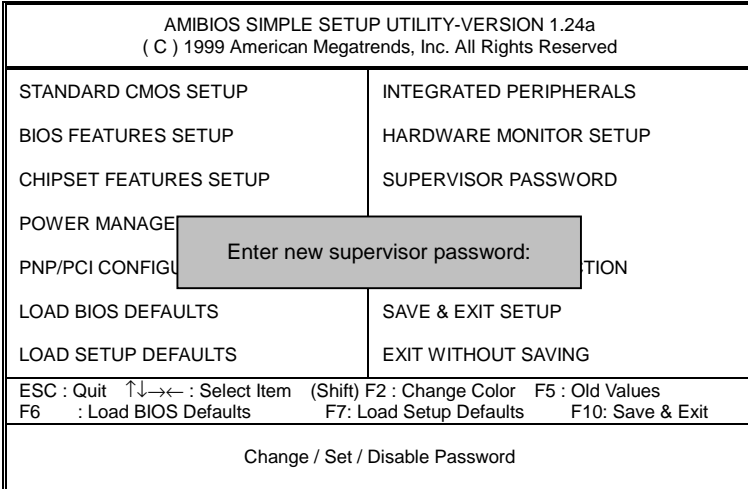

Figure 11: Password Setting

Type the password, up to six characters, and press <Enter>. You will be asked to confirm the password. Type the password again and press <Enter>. You may also press <Esc> to abort the selection and not enter a password.

To disable password, just press <Enter> when you are prompted to enter password. A message "PASSWORD DISABLED" will appear to confirm the password being disabled. Once the password is disabled, the system will boot and you can enter Setup freely.

The BIOS Setup program allows you to specify two separate passwords: a **SUPERVISOR PASSWORD** and a **USER PASSWORD**. When disabled, anyone may access all BIOS Setup program function. When enabled, the Supervisor password is required for entering the BIOS Setup program and having full configuration fields, the User password is required to access only basic items.

If you select "Always" at "Password Check" in BIOS Features Setup Menu, you will be prompted for the password every time the system is rebooted or any time you try to enter Setup Menu.

If you select "Setup" at "Password Check" in BIOS Features Setup Menu, you will be prompted only when you try to enter Setup.

IDE HDD Auto Detection

AMBIOS SETUP – STANDARD CMOS SETUP (C) 1999 American Megatrends, Inc. All Rights Reserved						
Date (mm/dd/yyyy) : Tue Jan 18, 2000						
Time (hh/mm/ss) : 10:36:24						
	TYPE	SIZE	CYLS	HEAD	PRECOMP	LANDZ SECTOR
MODE						
Pri Master : Auto						
Pri Slave : Auto						
Sec Master : Auto						
Sec Slave : Auto						
Floppy Drive A: 1.44 MB 3 ½				Base Memory : 640 kb		
Floppy Driver B: Not Installed				Other Memory : 384 kb		
Boot Sector Virus Protection : Disabled				Extended Memory : 31mb		
				Total Memory : 32mb		
Month:	Jan – Dec	ESC : Exit				
Day:	01 – 31	↑↓ : Select Item				
Year :	1990 – 2099	/PD/+/- : Modify				
		Shift)F2 : Color				

Figure 12: IDE HDD Auto Detection

Type "Y" will accept the H.D.D. parameter reported by BIOS.

Type "N" will keep the old H.D.D. parameter setup. If the hard disk cylinder number is over 1024, then the user can select LBA mode or LARGER mode for DOS partition larger than 528 MB.

Save & Exit Setup

AMIBIOS SIMPLE SETUP UTILITY-VERSION 1.24a (C) 1999 American Megatrends, Inc. All Rights Reserved	
STANDARD CMOS SETUP	INTEGRATED PERIPHERALS
BIOS FEATURES SETUP	HARDWARE MONITOR SETUP
CHIPSET FEATURES SETUP	SUPERVISOR PASSWORD
POWER MANAGEMENT	
PNP/PCI CONFIGURATION	
LOAD BIOS DEFAULTS	SAVE & EXIT SETUP
LOAD SETUP DEFAULTS	EXIT WITHOUT SAVING
ESC : Quit ↑↓→← : Select Item (Shift) F2 : Change Color F5 : Old Values F6 : Load BIOS Defaults F7: Load Setup Defaults F10: Save & Exit	
Save Data to CMOS & Exit SETUP	

Figure 13: Save & Exit Setup

Type "Y" will quit the Setup Utility and save the user setup value to RTC CMOS.

Type "N" will return to Setup Utility.

Exit Without Saving

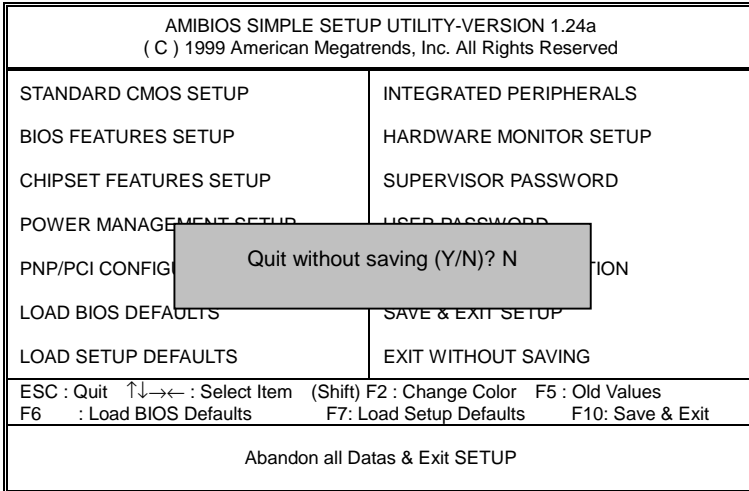

Figure 14: Exit Without Saving

Type "Y" will quit the Setup Utility and save the user setup value to RTC CMOS.

Type "N" will return to Setup Utility.

Technical Support /RMA Sheet

Customer/Country:	Company:	Phone No.:
Contact Person:	E-mail Add. :	

Model name/Lot Number:	PCB revision:
BIOS version:	O.S./A.S.:

Hardware Configuration	Mfs.	Model name	Size:	Driver/Utility:
CPU				
Memory Brand				
Video Card				
Audio Card				
HDD				
CD-ROM / DVD-ROM				
Modem				
Network				
AMR / CMR				
Keyboard				
Mouse				
Power supply				
Other Device				

Problem Description:

Appendix

Appendix A: Intel 850 Chipset Driver Installation

A. Windows 9x INF Update Utility

Insert the support CD that came with your motherboard into your CD-ROM drive or double-click the CD drive icon in **My Computer** to bring up the setup screen.

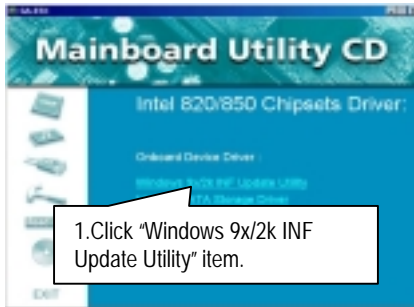

(1)

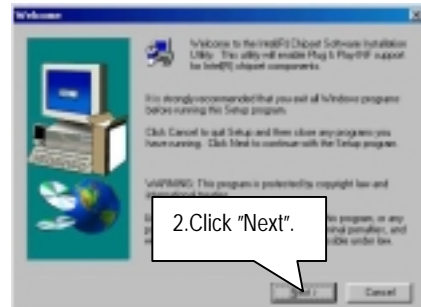

(2)

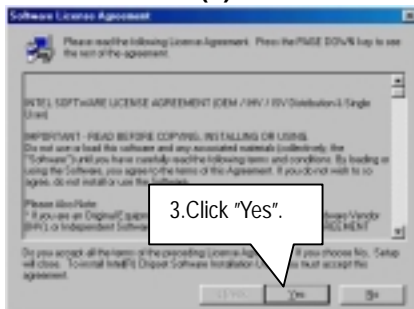

(3)

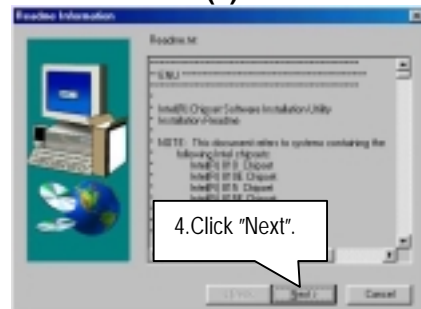

(4)



(5)

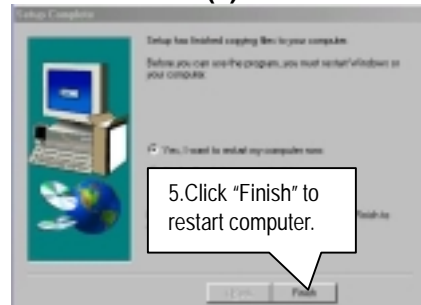

(6)

B. Intel ICH IDE ATA100 Driver Installation

Insert the support CD that came with your motherboard into your CD-ROM drive or double-click the CD drive icon in **My Computer** to bring up the setup screen.



(1)

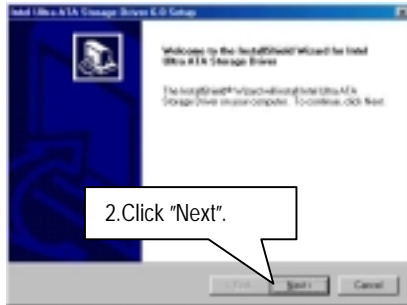

(2)

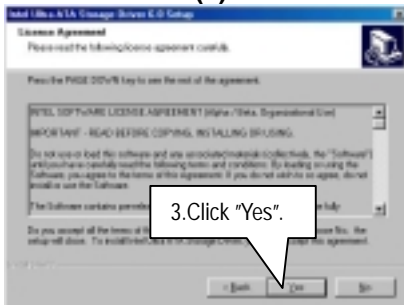

(3)

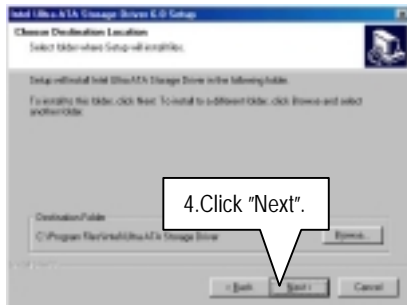

(4)

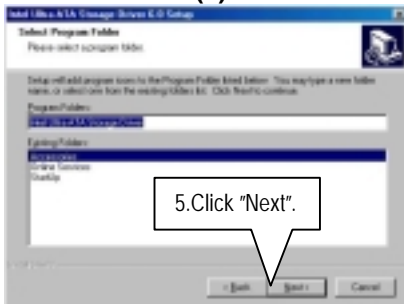

(5)



(6)

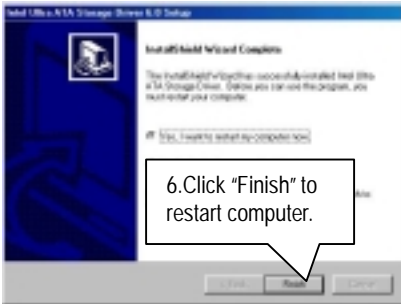

(7)

Appendix B: Creative Sound Driver Installation

Insert the support CD that came with your motherboard into your CD-ROM drive or double-click the CD drive icon in **My Computer** to bring up the setup screen.

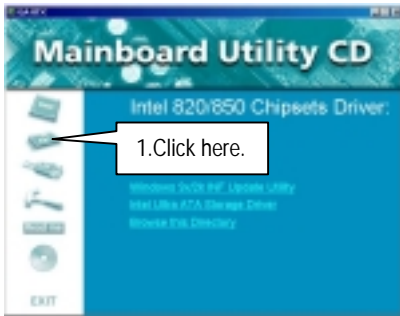

(1)

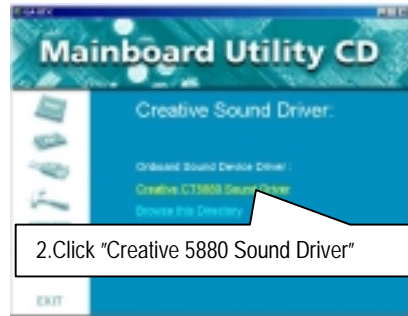

(2)

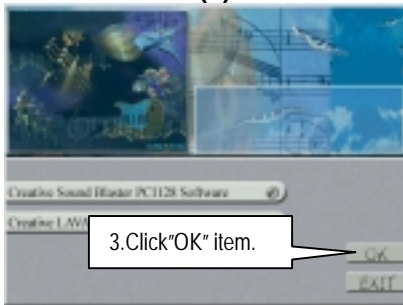

(3)

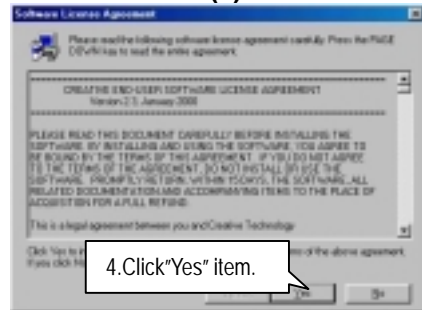

(4)

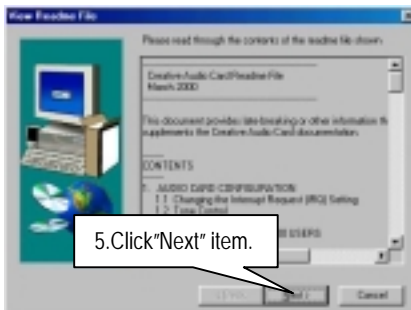

(5)

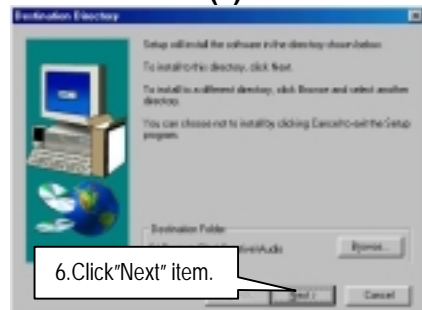

(6)

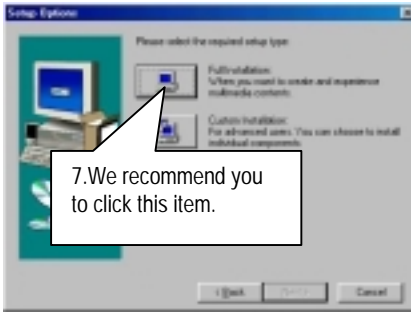

(7)

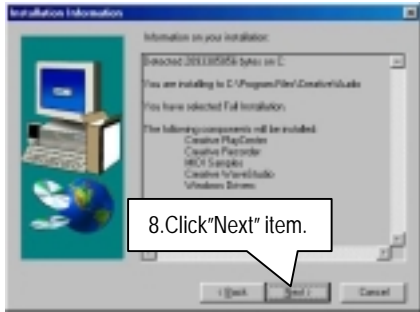

(8)



(9)

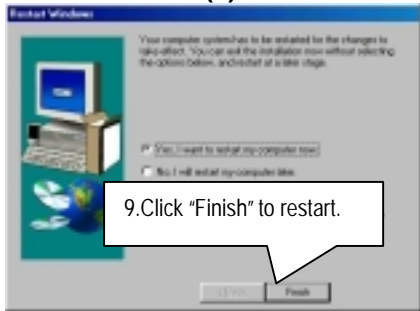

(10)

Appendix B: BIOS Flash Procedure

BIOS update procedure:

If your OS is Win9X, we recommend that you used Gigabyte @BIOS Program to flash BIOS.

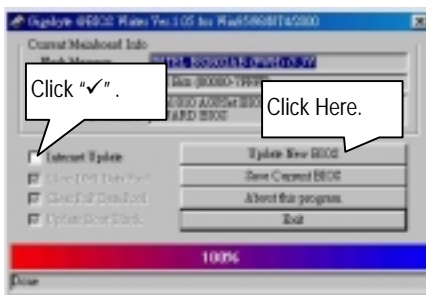
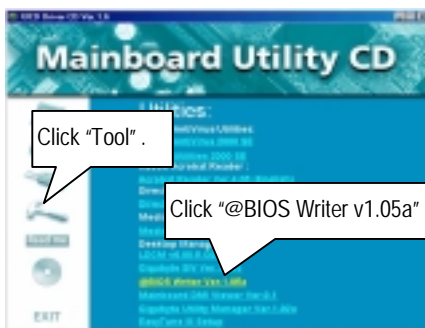

Methods and steps :

I. Update BIOS through Internet

- a. Click "Internet Update" icon
- b. Click "Update New BIOS" icon
- c. Select @BIOS sever ("Gigabyte @BIOS sever 1 in Taiwan" and "Gigabyte @BIOS sever 2 in Taiwan" are available for now, the others will be completed soon)
- d. Select the exact model name on your motherboard
- e. System will automatically download and update the BIOS.

II. Update BIOS **NOT** through Internet :

- a. **Do not** click "Internet Update" icon
- b. Click "Update New BIOS"
- c. Please select "All Files" in dialog box while opening the old file.
- d. Please search for BIOS unzip file, downloading from internet or any other methods (such as: 8TX.F1).
- e. Complete update process following the instruction.

III. Save BIOS

In the very beginning, there is "Save Current BIOS" icon shown in dialog box. It means to save the current BIOS version.

IV. Check out supported motherboard and Flash ROM :

In the very beginning, there is "About this program" icon shown in dialog box. It can help you check out which kind of motherboard and which brand of Flash ROM are supported.

Note :

- a. In method I, if it shows two or more motherboard's model names to be selected, please make sure your motherboard's model name again. Selecting name will cause the system unbooted.
- b. In method II, be sure that motherboard's model name in BIOS unzip file are the same as your motherboard's. Otherwise, your system won't boot.
- c. In method I, if the BIOS file you need cannot be found in @BIOS server, please go onto Gigabyte's web site for downloading and updating it according to method II.
- d. Please note that any intercorruption during updating will cause system unbooted

8TX Motherboard

Or else you can select flash BIOS in DOS mode.

 Please check your **BIOS vendor (AMI or AWARD)**, your **motherboard name** and **PCB version** on the motherboard.

1. Format a bootable system floppy diskette by the command "**format a:/s**" in command mode.
2. Visit the Gigabyte website at [http:// www.gigabyte.com.tw](http://www.gigabyte.com.tw), Select the BIOS file you need and download it to your bootable floppy diskette.
3. Insert the bootable diskette containing the BIOS file into the floppy diskette driver.
4. Assuming that the floppy diskette driver is A, reboot the system by using the A: driver. At the A: > prompt, run the BIOS upgraded file by executing the Flash BIOS utility and the BIOS file with its appropriate extension.

Example: *(AMI tool) (Where 8TX.f1 is name of the BIOS file name)*

```
A:>flashxxx.exe 8TX.f1 ↵
```

Example: *(Award tool) (Where 8TX.f1 is name of the BIOS file name)*

```
A:>wdf1ash.exe 8TX.f1 ↵
```

5. Upon pressing the <Enter> key, a flash memory writer menu will appear on screen. Enter the new BIOS file name with its extension filename into the text box after file name to program.
6. If you want to save the old BIOS file(perform as soon as system is operational, this is recommended), select Y to **DO YOU WANT TO SAVE BIOS**, then type the old BIOS filename and the extension after filename to save: This option allows you to copy the contents of the flash memory chip onto a diskette, giving you a backup copy of the original motherboard BIOS in case you need to re-install it. Select N to **DO YOU WANT TO SAVE BIOS**, if you don't want to save the old BIOS file.
7. After the decision to save the old BIOS file or not is made, select Y to **ARE YOU SURE TO PROGRAM** when the next menu appear; wait until a message showing Power Off or Reset the system appears. Then turn off your system.
8. Remove the diskette and restart your system.
9. Hold down <Delete> key to enter BIOS setup. You must select "Load Setup BIOS Default" to activate the new BIOS, then you may set other item from the main menu.

Appendix D: Acronyms

Acronyms	Meaning
ACPI	Advanced Configuration and Power Interface
APM	Advanced Power Management
AGP	Accelerated Graphics Port
AMR	Audio Modem Riser
ACR	Advanced Communications Riser
BIOS	Basic Input / Output System
CPU	Central Processing Unit
CMOS	Complementary Metal Oxide Semiconductor
CRIMM	Continuity RIMM
CNR	Communication and Networking Riser
DMA	Direct Memory Access
DMI	Desktop Management Interface
DIMM	Dual Inline Memory Module
DRM	Dual Retention Mechanism
DRAM	Dynamic Random Access Memory
DDR	Double Data Rate
ECP	Extended Capabilities Port
ESCD	Extended System Configuration Data
ECC	Error Checking and Correcting
EMC	Electromagnetic Compatibility
EPP	Enhanced Parallel Port
ESD	Electrostatic Discharge
FDD	Floppy Disk Device
FSB	Front Side Bus
HDD	Hard Disk Device
IDE	Integrated Dual Channel Enhanced
IRO	Interrupt Request
I/O	Input / Output
IOAPIC	Input Output Advanced Programmable Input Controller
ISA	Industry Standard Architecture
LAN	Local Area Network
LBA	Logical Block Addressing
LED	Light Emitting Diode
MHz	Megahertz
MIDI	Musical Interface Digital Interface
MTH	Memory Translator Hub
MPT	Memory Protocol Translator
NIC	Network Interface Card
OS	Operating System

To be continued...

8TX Motherboard

Acronyms	Meaning
OEM	Original Equipment Manufacturer
PAC	PCI A.G.P. Controller
POST	Power-On Self Test
PCI	Peripheral Component Interconnect
RIMM	Rambus in-line Memory Module
SCI	Special Circumstance Instructions
SECC	Single Edge Contact Cartridge
SRAM	Static Random Access Memory
SMP	Symmetric Multi-Processing
SMI	System Management Interrupt
USB	Universal Serial Bus
VID	Voltage ID