

GA – 686SLX

USER'S MANUAL

1. **System power on by PS/2 Mouse:** If you are using ATX power supply, you are able to power on the system by double clicking the right or left button of your PS/2 Mouse.
2. **System power on by Keyboard:** If your ATX power supply supports 1 ampere 5V Stand-By function, you can power on your system by entering password from keyboard.
3. **Modem Ring-On on COM B.**
4. **Wake-Up on LAN. (on JP6)**
5. **Supports 3 or 4 steps ACPI LED selectable.(on JP7)**

Pentium® II Processor MAINBOARD

REV. 1.0 First Edition

R-01-01-071212

The author assumes no responsibility for any errors or omissions that may appear in this document nor does it make a commitment to update the information contained herein.

Third-party brands and names are the property of their respective owners.

November 11, 1997 Taipei, Taiwan

I. Quick Installation Guide :

CPU SPEED SETUP

The system's speed is fixed to 66.6MHz. The user can change the DIP SWITCH **(SW)** selection to set up the CPU speed for 200 - 633MHz processor.

The CPU speed **MUST** match with the frequency RATIO. It will cause system hanging up if the frequency RATIO is higher than that of CPU.

| DIP SWITCH (SW) | | | | FREQ. RATIO | EXT.CLK. MHz | INT.CLK. MHz | CPU Type |
|-----------------|-----|-----|-----|----------------|-----------------|-----------------|---------------------|
| 1 | 2 | 3 | 4 | | | | |
| OFF | ON | OFF | OFF | 3 | 66 | 200 | Pentium® II 200 MHz |
| ON | ON | OFF | OFF | 3.5 | 66 | 233 | Pentium® II 233 MHz |
| OFF | OFF | ON | OFF | 4 | 66 | 266 | Pentium® II 266 MHz |
| ON | OFF | ON | OFF | 4.5 | 66 | 300 | Pentium® II 300 MHz |
| OFF | ON | ON | OFF | 5 | 66 | 333 | Pentium® II 333 MHz |
| ON | ON | ON | OFF | 5.5 | 66 | 366 | Pentium® II 366 MHz |

1. Pentium® II 200 MHz

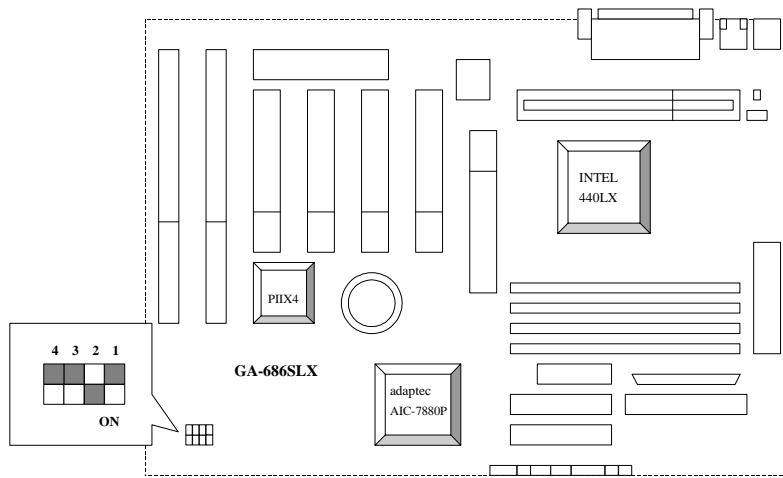

2. Pentium® II 233 MHz

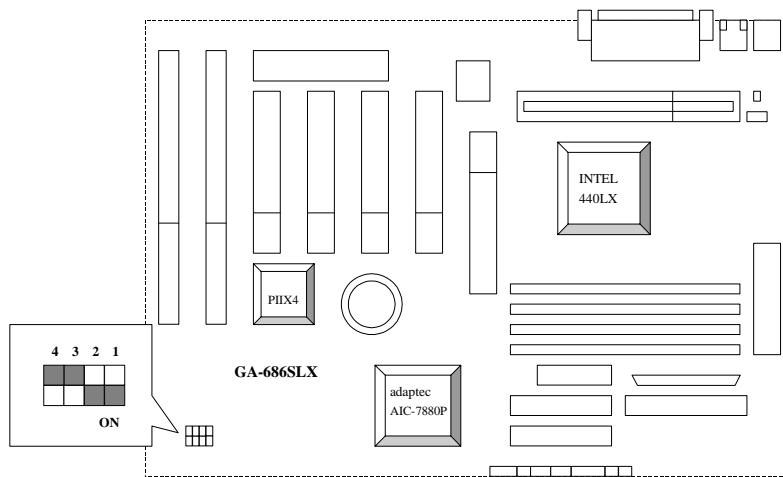

3. Pentium® II 266 MHz

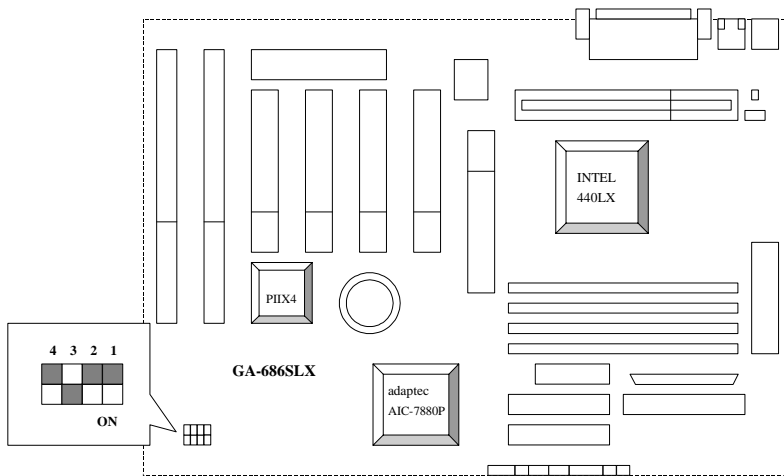

4. Pentium® II 300 MHz

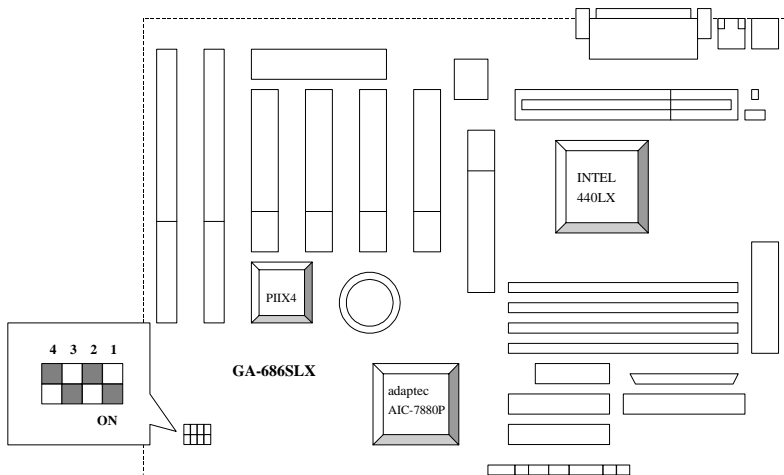

5. Pentium® II 333 MHz

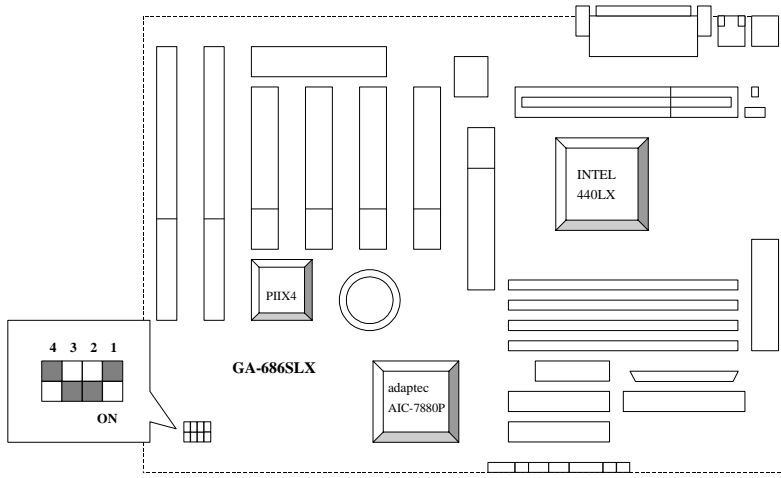

6. Pentium® II 366 MHz

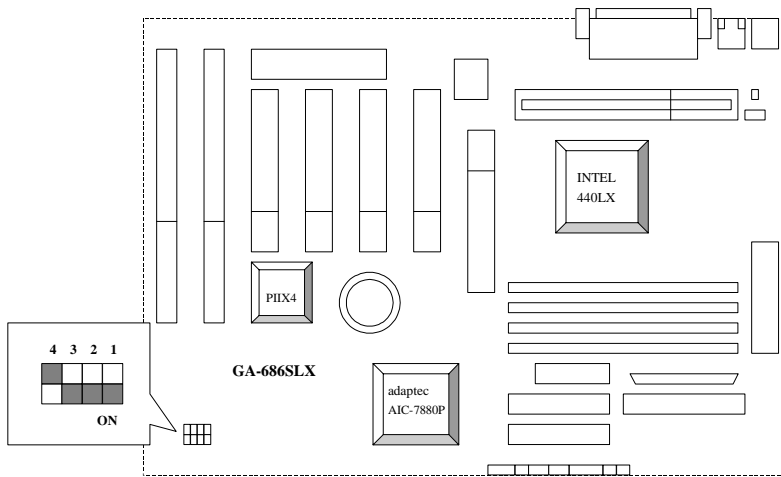

II. Jumper setting :

PWR : Power LED Connector

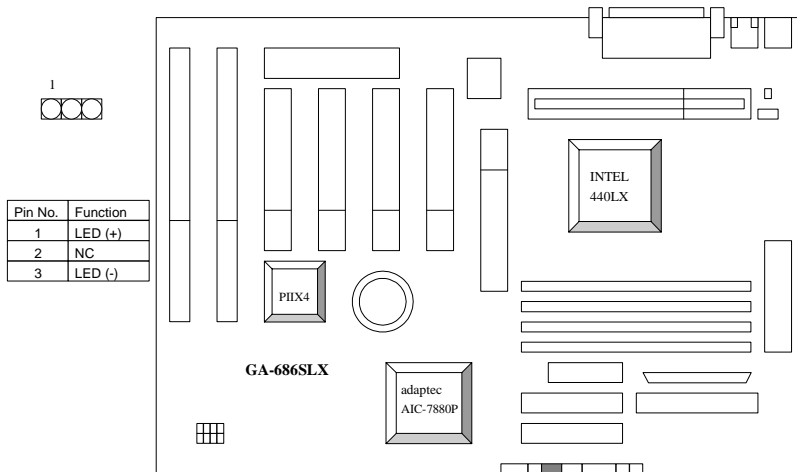

SPK : Speaker Connector

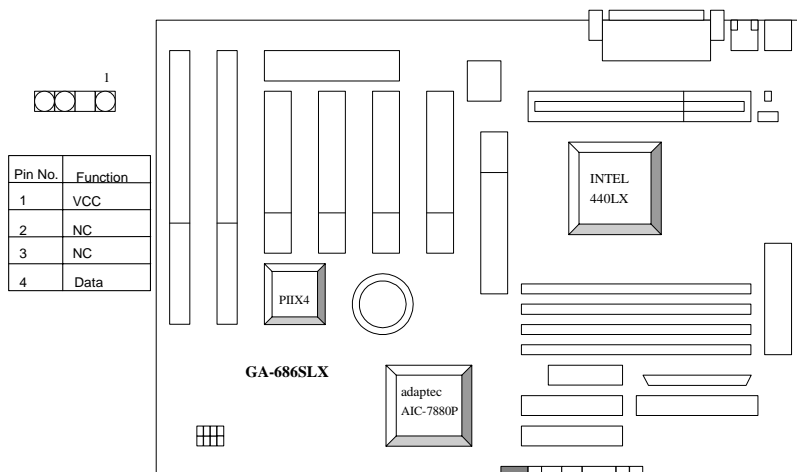

RST : Reset Switch

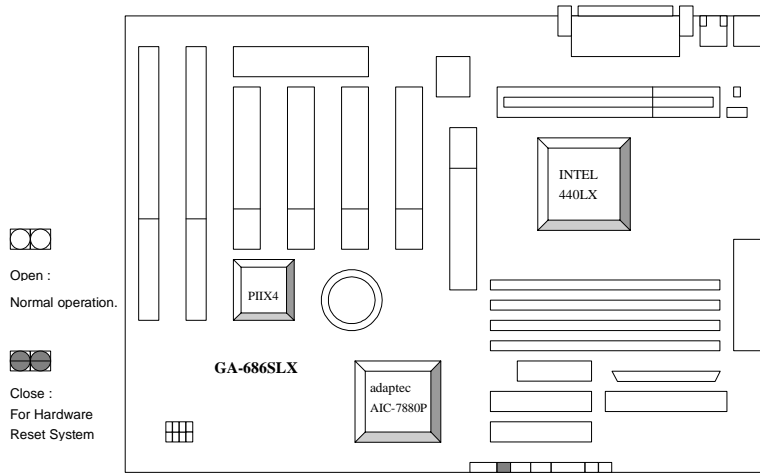

GN : Green Function Switch

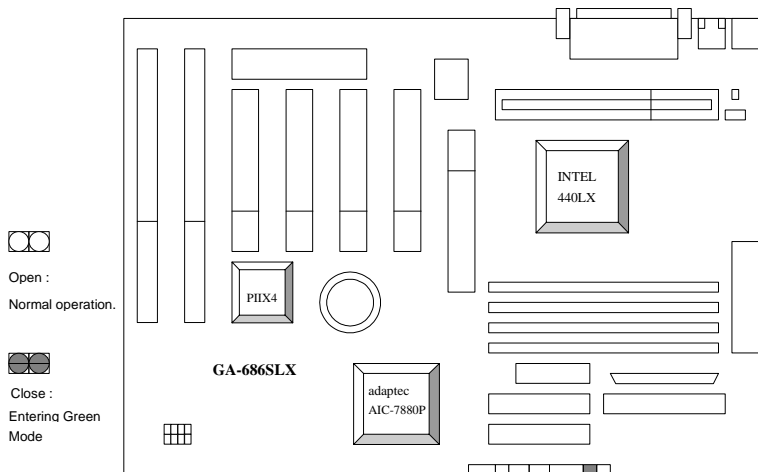

HD : IDE Hard Disk Active LED

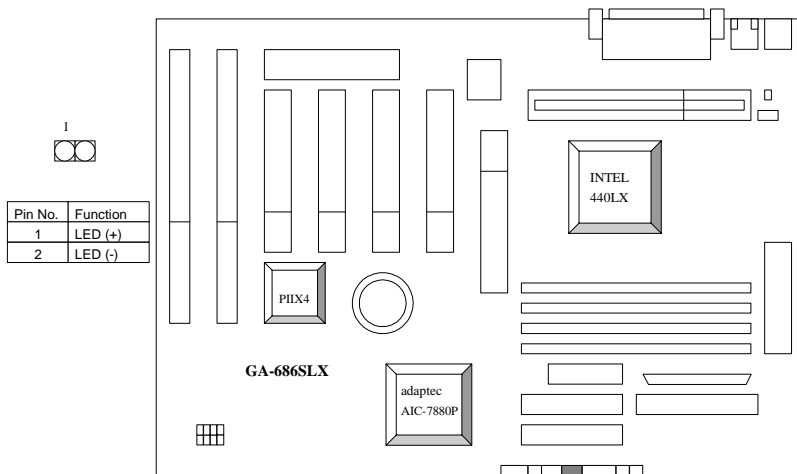

Soft PWR : Soft Power Connector

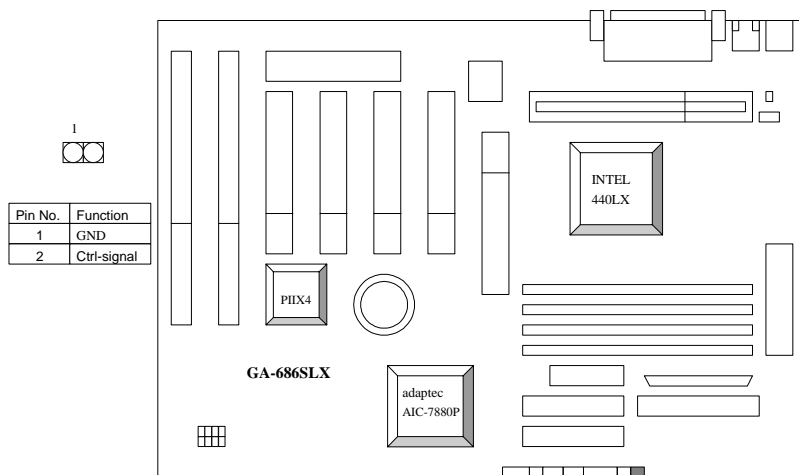

POWER : Power Connector

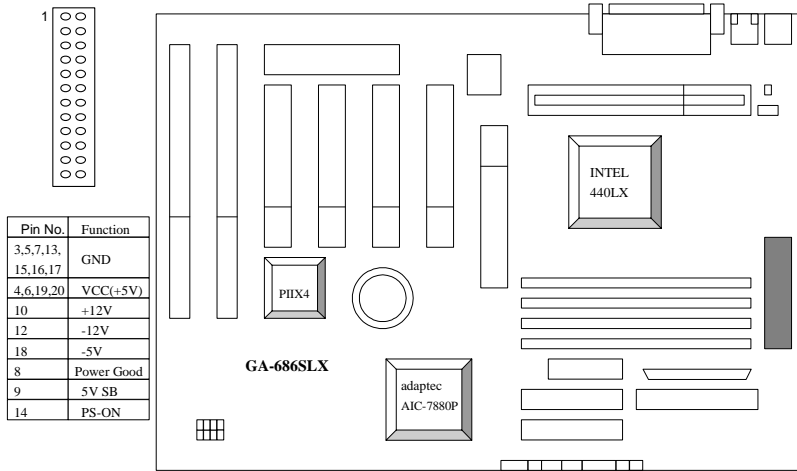

PS/2 Mouse / Keyboard Connector

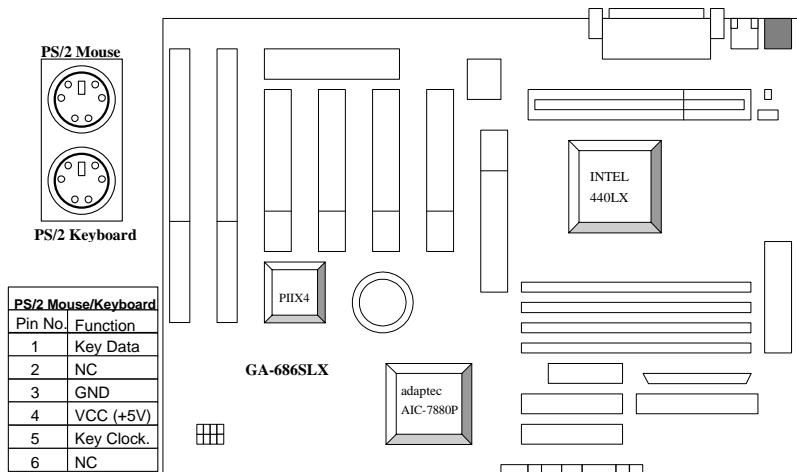

J2 : CPU Cooling Fan Power Connector

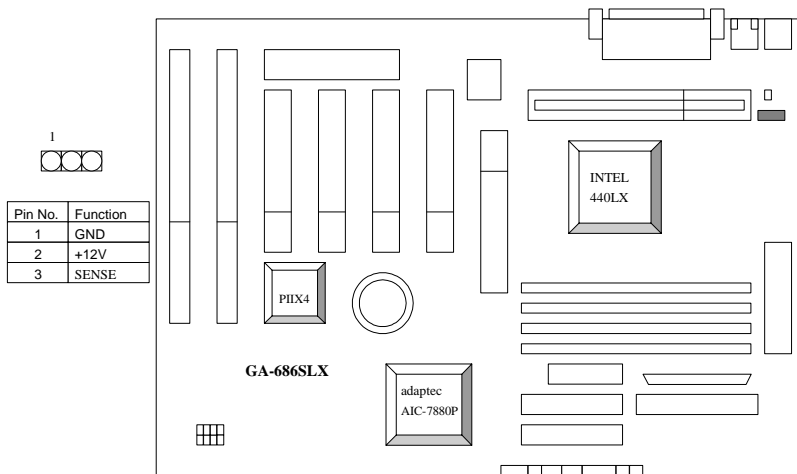

IDE1: For Primary IDE port

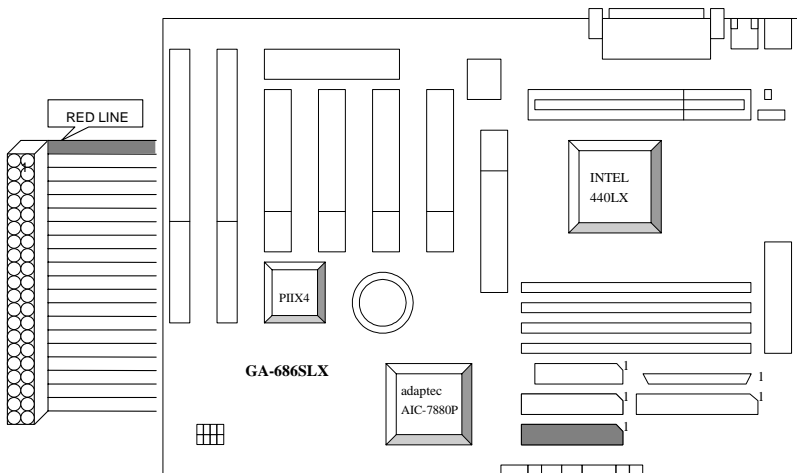

IDE2: For Secondary IDE port

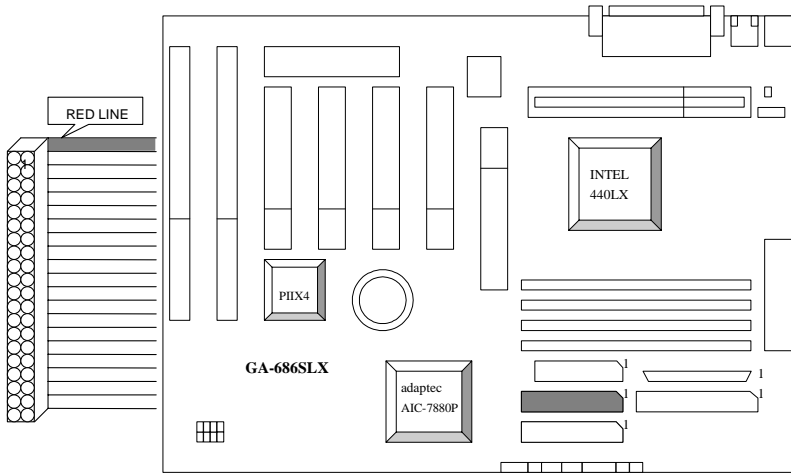

J7 : FLOPPY PORT

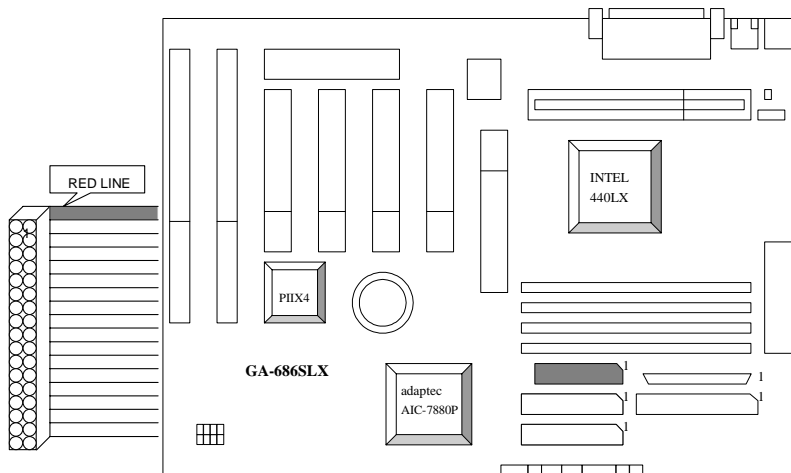

ULTRA SCSI : ON BOARD ULTRA SCSI PORT

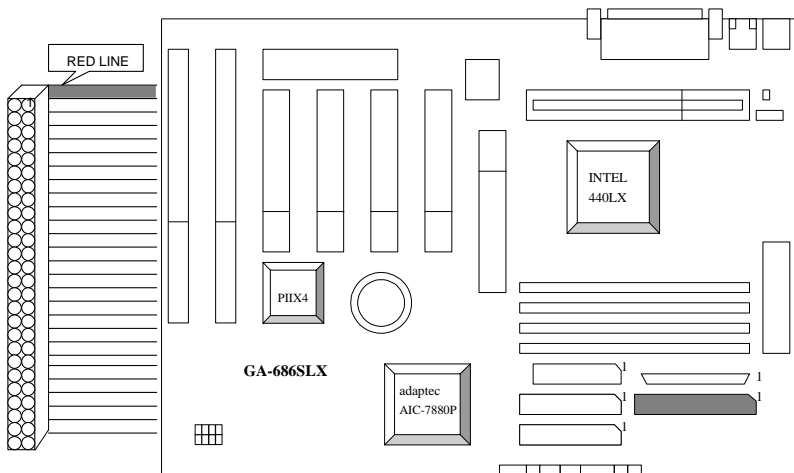

ULTRA WIDE SCSI : ON BOARD ULTRA WIDE SCSI PORT

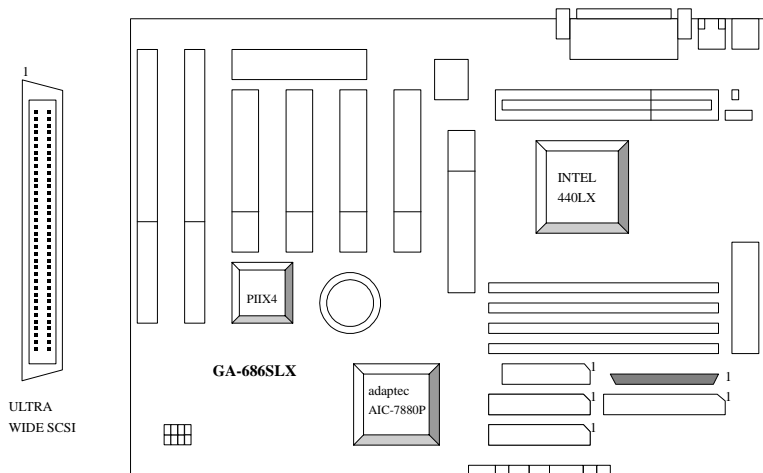

LPT PORT / COM A / COM B

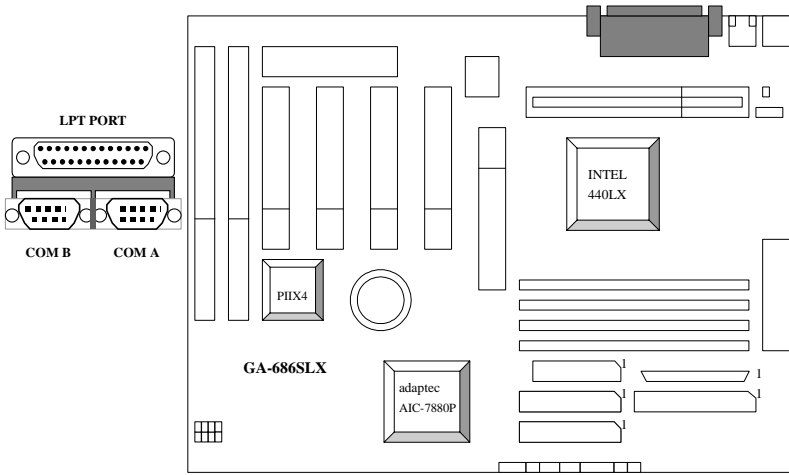

JP1 : Keyboard Power On

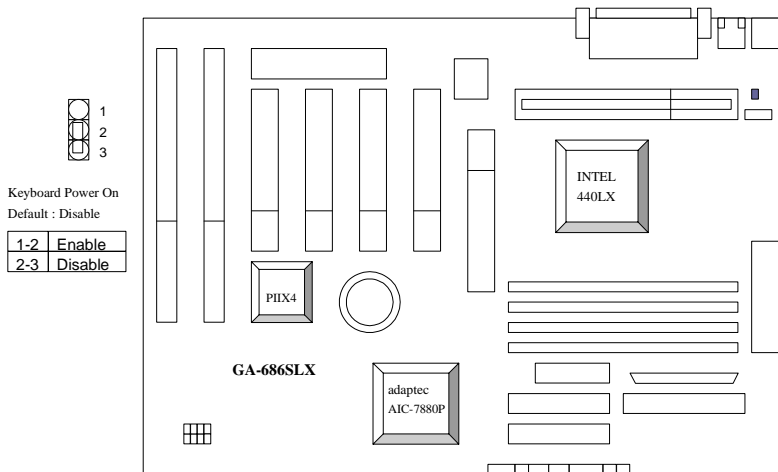

CN1: USB Port

| Pin No. | Function |
|---------|----------|
| 1 | USB V0 |
| 2 | USB D0- |
| 3 | USB D0+ |
| 4 | GND |
| 5 | USB V0 |
| 6 | USB D0- |
| 7 | USB D0+ |
| 8 | GND |

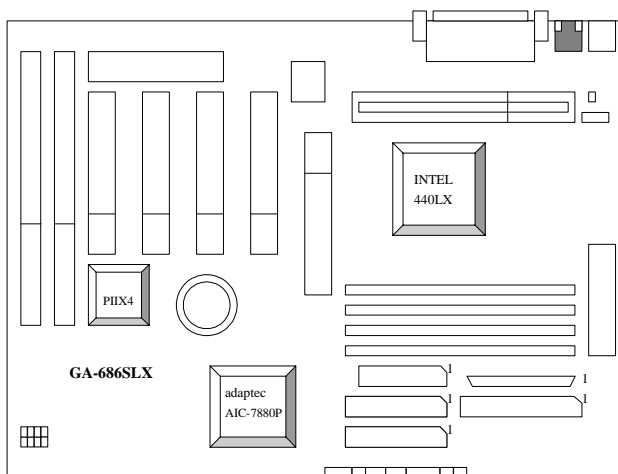

JP6: Wake on LAN



| Pin No. | Function |
|---------|----------|
| 1 | +5V SB |
| 2 | GND |
| 3 | Signal |

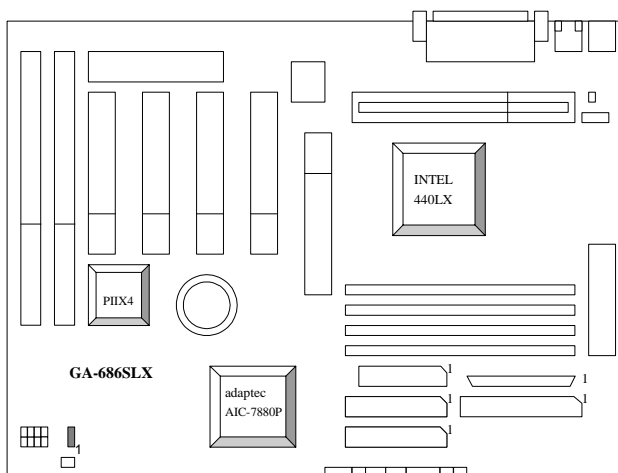

JP7: ACPI LED Selection

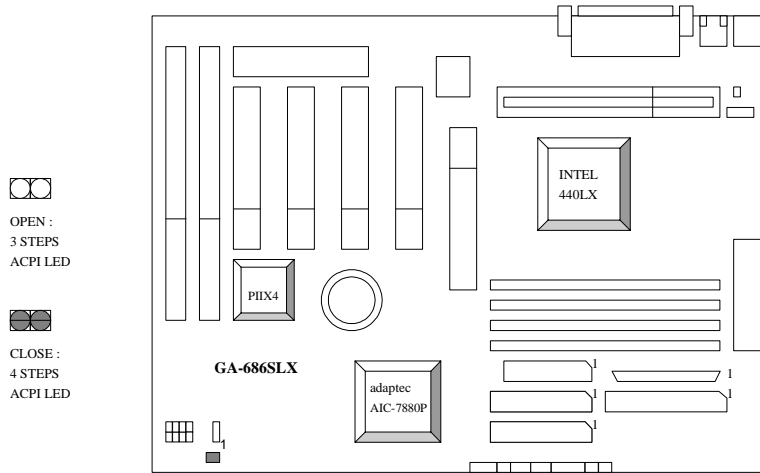

J13: ATX Power Control Selection

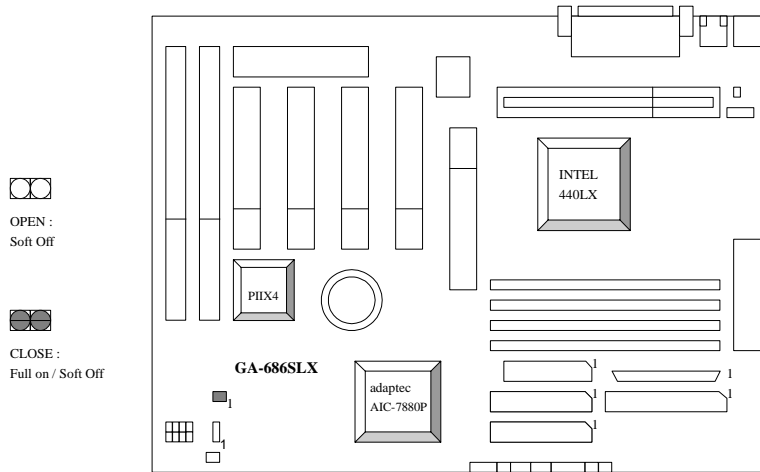

JP5: For PCI Audio / Sound Card use only

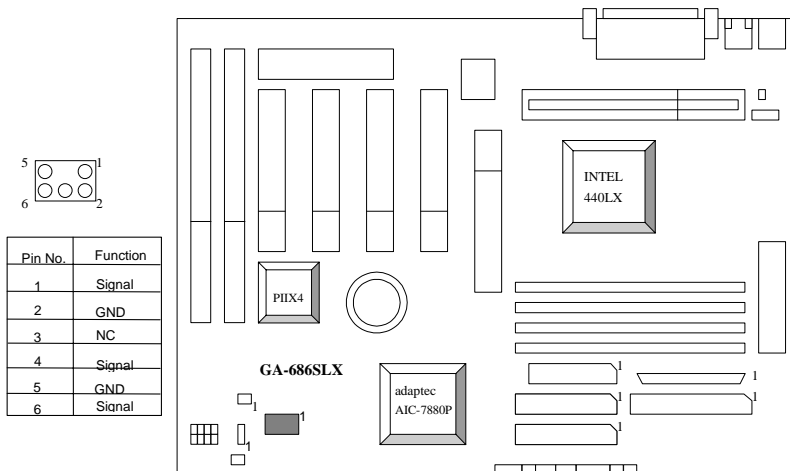

III. Top Performance Test Setting:

Users have to modify the value for each item in chipset features as follow for top performance setting.

ROM PCI / ISA BIOS
CHIPSET FEATURES SETUP
AWARD SOFTWARE INC

| | | | |
|--------------------------|------------|-------------------------------------|------------------|
| Auto Configuration | · Enabled | CPU Temperature Select | : 70 °C / 158 °F |
| DRAM Speed Selection | · Fast | Slow Down CPU Data Cycle | · Normal |
| Memory Ruffier Strength | · Middle | Alarm When Overheat | · Disabled |
| DRAM Data Integrity Mode | · Non-ECC | Fan Failure Control | · Disabled |
| Video RAM Cacheable | · Disabled | CPU Fan Status | · XXXX |
| 16 Bit I/O Recovery Time | · 1 | CPU Temperature | · OK |
| Memory Hole At 15M-16M | · Disabled | Power Supply +12V | · OK |
| Delayed Transaction | · Disabled | Power Supply +17V | · OK |
| SDRAM RAS-to-CAS Delay | · Fast | Power Supply +5V | · OK |
| SDRAM RAS Precharge Time | · Fast | Power Supply -5V | · OK |
| SDRAM CAS latency Time | · 2 | Raffery Status | · OK |
| | | CPU VCore Voltage | · 2.8V |
| | | ESC : Quit ↑ ↓ → ← : Select Item | |
| | | F1 : Help P1/P2/... : Modify | |
| | | F5 : Old Value / Shift/F2 : Color | |
| | | F7 : Load Setup Defaults | |

TABLE OF CONTENTS

1. INTRODUCTION..... 1-1

1.1. PREFACE1-1

1.2. KEY FEATURES1-1

1.3. PERFORMANCE LIST1-2

1.4. BLOCK DIAGRAM.....1-3

1.5. INTRODUCE THE Pentium® II Processor1-4

1.6. What is AGP?.....1-6

2. SPECIFICATION 2-1

2.1. HARDWARE2-1

2.2. SOFTWARE2-2

2.3. ENVIRONMENT2-2

3. HARDWARE INSTALLATION..... 3-1

3.1. UNPACKING3-1

3.2. MAINBOARD LAYOUT3-2

3.3. QUICK REFERENCE FOR JUMPERS & CONNECTORS3-2

3.4. DRAM INSTALLATION3-5

3.5. CPU SPEED SETUP.....3-5

3.6. CMOS RTC & ISA CFG CMOS SRAM.....3-6

3.7. SPEAKER CONNECTOR INSTALLATION3-6

3.8. HARDWARE RESET SWITCH CONNECTOR INSTALLATION.....3-6

3.9. POWER LED CONNECTOR INSTALLATION.....3-6

| | |
|--|------------|
| 3.10. IDE & ATAPI DEVICE INSTALLATION | 3-6 |
| 3.11. SCSI DEVICE INSTALLATION | 3-6 |
| 3.12. PERIPHERAL DEVICE INSTALLATION | 3-9 |
| 3.13. KEYBOARD & PS/2 MOUSE INSTALLATION | 3-9 |
| 4. BIOS CONFIGURATION | 4-1 |
| 4.1. ENTERING SETUP | 4-1 |
| 4.2. CONTROL KEYS | 4-1 |
| 4.3. GETTING HELP | 4-2 |
| 4.3.1. Main Menu | 4-2 |
| 4.3.2. Status Page Setup Menu / Option Page Setup Menu | 4-2 |
| 4.4. THE MAIN MENU | 4-2 |
| 4.5. STANDARD CMOS SETUP MENU | 4-4 |
| 4.6. BIOS FEATURES SETUP | 4-8 |
| 4.7. CHIPSET FEATURES SETUP | 4-12 |
| 4.8. POWER MANAGEMENT SETUP | 4-17 |
| 4.9. PNP/PCI CONFIGURATION | 4-21 |
| 4.10. INTEGRATED PERIPHERALS | 4-23 |
| 4.11. LOAD SETUP DEFAULTS | 4-28 |
| 4.12. USER PASSWORD | 4-29 |
| 4.13. IDE HDD AUTO DETECTION | 4-30 |
| 4.14. SAVE & EXIT SETUP | 4-31 |
| 4.15. EXIT WITHOUT SAVING | 4-32 |

1. INTRODUCTION

1.1. PREFACE

Welcome to use the **GA-686SLX** motherboard. It is a Pentium® II Processor based PC / AT compatible system with AGP / PCI / SCSI / ISA Bus, and has been designed to be the fastest PC / AT system. There are some new features allow you to operate the system with just the performance you want.

This manual also explains how to install the motherboard for operation, and how to set up your CMOS CONFIGURATION with BIOS SETUP program.

1.2. KEY FEATURES

- ❑ Intel Pentium® II Processor based PC / AT compatible mainboard.
- ❑ Slot 1 supports Pentium® II processor running at 200-633 MHz.
- ❑ Intel 440LX chipset, Supports AGP / SDRAM / Ultra DMA/33 IDE / Wake on LAN / Keyboard and PS/2 Mouse Power On / ACPI features.
- ❑ Supports CPU FAN Failure / Overheat Alarm & auto slow down CPU speed.
- ❑ Supports Intel LDCM® Network Manageability.
- ❑ Supports 4xDIMMs using 3.3V EDO or SDRAM DIMM module.
- ❑ Supports 8 MB - 1 GB EDO / 512MB SDRAM memory on board.
- ❑ Supports ECC or Non-ECC type DRAM module.
- ❑ 1xAGP slot, 4xPCI Bus slots, 2xISA Bus slots.
- ❑ Supports 2 channels Ultra DMA/33 IDE ports for 4 IDE Devices.
- ❑ Supports both Ultra SCSI and Ultra Wide SCSI ports.
- ❑ Supports 2xCOM (16550), 1xLPT (EPP / ECP), 1x1.44MB Floppy port.
- ❑ Supports 2xUSB ports, 1xPS/2 Mouse.
- ❑ Licensed AWARD BIOS, 2M bit FLASH RAM.
- ❑ 31 cm x 21 cm ATX SIZE form factor, 4 layers PCB.

1.3. PERFORMANCE LIST

The following performance data list is the testing results of some popular benchmark testing programs.

These data are just referred by users, and there is no responsibility for different testing data values gotten by users. (The different Hardware & Software configuration will result in different benchmark testing results.)

- CPU Pentium® II processor
- DRAM 64 MB SDRAM
- CACHE SIZE 512 KB included in CPU
- DISPLAY Matrox Millennium II 4MB PCI VGA
- STORAGE Onboard IDE port
- O.S. Windows95 OSR2.0.
- DRIVER Display Driver at 1024 x 768 x 64K colors x 75Hz.
Triones Bus Master IDE Driver 3.60K

| Processor | Intel Pentium® II | |
|--------------------|-------------------|-------------|
| | 266MHz | 300MHz |
| Winbench97 | | |
| CPU mark32 | 697 | 783 |
| Business Disk | 2210 | 2260 |
| Hi-End Disk | 5890 | 6490 |
| Business Graphics | 116 | 127 |
| Hi-End Graphics | 50.8 | 56.3 |
| Winstone 97 | | |
| Business | 62 | 64.9 |
| Hi-End | 30.6 | 32.6 |

1.4. BLOCK DIAGRAM

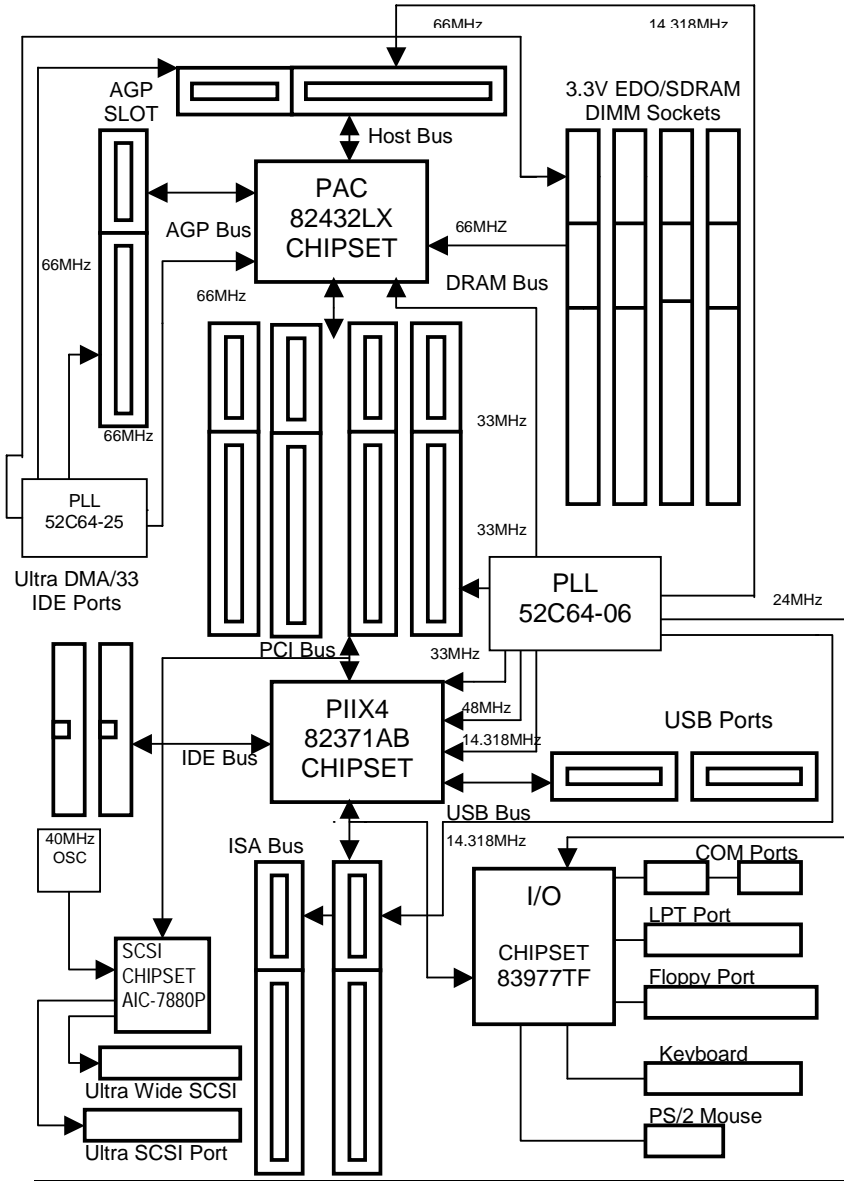

1.5. INTRODUCE THE Pentium® II Processor & AGP



Figure 1:Retention Mechanism & attach Mount



Figure 2:OEM Pentium® II Processor



Figure 3:Heatsink / FAN & Heat sink support for OEM Pentium® II Processor



Figure 4:Boxed Pentium® II Processor & Heat sink support

1.6 What is AGP?

The Accelerated Graphics Port (AGP) is a new port on the Host-To-PCI bridge device that supports an AGP port. The main purpose of the AGP port is to provide fast access to system memory.

The AGP port can be used either as fast PCI port (32-bits at 66MHz vs. 32-bits at 33MHz) or as an AGP port which supports 2x data-rate, a read queue, and side band addressing. When the 2x-data rate is used the port can transmit data at 533MB/sec ($66.6 \times 2 \times 4$). The read-queue can be used to pipeline reads – removing the effects of the reads-latency. Side band addressing can be used to transmit the data address on a separate line in order to speed up the transaction.

2. SPECIFICATION

2.1. HARDWARE

- CPU
 - Pentium® II processor 200 – 633 MHz.
 - 242 pins 66MHz slot1 on board.
- PROTECTION
 - Onboard Speaker Alarm when detect "CPU FAN Failure" or "CPU Overheat".
 - Automatically slow down CPU speed when "CPU Overheat".
 - Intel LDCM® supported.
 - H/W monitor power status ($\pm 5V$, $\pm 12V$, CPU voltage & CMOS battery voltage).
- SPEED
 - 66 MHz system speed.
 - 66 MHz AGP bus speed. (133MHz 2*mode)
 - 33 MHz PCI-Bus speed.
 - 8 MHz AT bus speed.
- DRAM MEMORY
 - 4 banks 168 pins DIMM module sockets on board.
 - Use 8 / 16 / 32 / 64 / 128 / 256 MB 60~70 ns DIMM module DRAM.
 - 8 ~ 1 GB EDO/512 MB SDRAM.
 - Supports 3.3V SDRAM / EDO type DRAM.
 - Supports ECC or Non-ECC type DRAM.
- CACHE MEMORY
 - 32 KB 1st cache memory included in CPU.
 - 256KB/512 KB 2nd cache in CPU.
 - Supports DIB speed mode for L2 Cache.
- I/O BUS SLOTS
 - 4 33MHz Master / Slave PCI-BUS.
 - 2 8MHz 16 bits ISA BUS.
 - 1 66MHz / 133MHz AGP bus.
- IDE PORTS
 - 2 Ultra DMA/33 Bus Master IDE channels on board.(Using IRQ14,15)
 - Support Mode 3,4 IDE & ATAPI CD – ROM.

- SCSI PORTS
 - Supports 1 Ultra Wide SCSI port.
 - Supports 1 Ultra SCSI port.
- I/O PORTS
 - Supports 2 16550 COM ports.
 - Supports 1 EPP/ECP LPT port.
 - Supports 1 1.44/2.88 MB Floppy port.
 - Supports 2 USB ports.
 - Supports PS/2 Mouse.
- GREEN FUNCTION
 - Suspend mode support.
 - Green switch & ACPI LED support.
 - IDE & Display power down support.
 - Monitor all IRQ / DMA / Display / I/O events.
- BIOS
 - 2M bits FLASH RAM.
 - Supports Plug & Play, DMI, ACPI Function.
- DIMENSION
 - ATX Form Factor, 4 layers PCB.

2.2. SOFTWARE

- DRIVER
 - Intel LDCM® optional.
 - Health monitor Utility.
 - Bus Master IDE Driver.
 - Suspend to HD utility.
- BIOS
 - Licensed AWARD BIOS.
 - AT CMOS Setup, BIOS / Chipset Setup, Green Setup, Hard Disk Utility included.
 - Monitor Health status.
- O.S.
 - Operation with MS-DOS®, Windows®95, WINDOWS™ NT, OS/2, NOVELL and SCO UNIX.

2.3. ENVIRONMENT

- Ambient Temp.
 - 0°C to +50°C (Operating).
- Relative Hum.
 - 0 to +85% (Operating).
- Altitude
 - 0 to 10,000 feet (Operating).
- Vibration
 - 0 to 1,000 Hz.
- Electricity
 - 4.9 V to 5.2 V. (Max. 20A current at 5V.)

3. HARDWARE INSTALLATION

3.1. UNPACKING

The mainboard package should contain the following:

- The **GA – 686SLX** mainboard.
- The Retention Mechanism & Attach Mount
- USER'S MANUAL for mainboard.
- Cable set for IDE, Floppy, SCSI & I/O devices.
- Diskette or CD for Mainboard Utility.
- External SCSI port adapter.

The mainboard contains sensitive electric components, which can be easily damaged by static electricity, so the mainboard should be left in its original packing until it is installed.

Unpacking and installation should be done on a grounded anti-static mat. The operator should be wearing an anti static wristband, grounded at the same point as the anti-static mat.

Inspect the mainboard carton for obvious damage. Shipping and handling may cause damage to your board. Be sure there are no shipping and handling damages on the board before proceeding.

After opening the mainboard carton, extract the system board and place it only on a grounded anti-static surface component side up. Again inspect the board for damage. Press down on all of the socket IC's to make sure that they are properly seated. Do this only on with the board placed on a firm flat surface.

⚠ **DO NOT APPLY POWER TO THE BOARD IF IT HAS BEEN DAMAGED.**

3.2. MAINBOARD LAYOUT

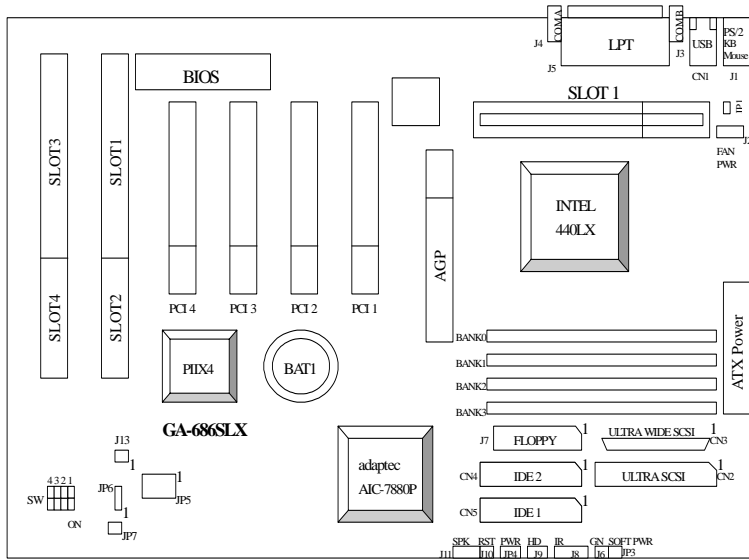

<Figure 3.1>

3.3. QUICK REFERENCE FOR JUMPERS & CONNECTORS

| ◆ I/O Ports Connector | |
|-----------------------|---------------------------|
| CN1 | USB port. |
| CN2 | Ultra SCSI port |
| CN3 | Ultra Wide SCSI port |
| IDE1 | For Primary IDE port. |
| IDE2 | For Secondary IDE port. |
| J1 | For PS/2 Keyboard port. |
| J1 | For PS/2 Mouse port. |
| J7 | For Floppy port |
| J3 | For Serial port2 (COM B). |
| J4 | For Serial port1 (COM A). |

| | |
|----|---------------|
| J5 | For LPT port. |
|----|---------------|

| | |
|--------------|-------------|
| ◆ GN : GN-SW | |
| Pin No. | Function |
| 1 | CTRL-Signal |
| 2 | GND |

| | |
|--------------------------------------|---------------|
| ◆ HD : Hard Disk active LED (HD-LED) | |
| Pin No. | Function |
| 1 | LED POWER (+) |
| 2 | LED POWER (-) |

| | |
|--|----------|
| ◆ J2 : CPU cooling FAN Power Connector | |
| Pin No. | Function |
| 1 | GND. |
| 2 | +12V |
| 3 | SENSE |

| | |
|------------------------------|----------|
| ◆ J13 : System After Ac Back | |
| Pin No. | Function |
| 1 | Signal |
| 2 | GND |

| | |
|-------------------------------------|-----------------------------|
| ◆ JP1 : Keyboard Power On Selection | |
| Pin No. | Function |
| 1-2 | Enabled Keyboard power on. |
| 2-3 | Disabled Keyboard power on. |

| | |
|---|----------|
| ◆ JP5 : For PCI Audio / Sound Card use only | |
| Pin No. | Function |
| 1 | Signal |
| 2 | GND |
| 3 | NC |
| 4 | Signal |
| 5 | GND |
| 6 | Signal |

| ◆ JP6 : Wake on LAN | |
|---------------------|----------|
| Pin No. | Function |
| 1 | +5V SB |
| 2 | GND |
| 3 | Signal |

| ◆ JP7 : ACPI LED selection | |
|----------------------------|----------|
| Pin No. | Function |
| 1 | Signal |
| 2 | GND |

| ◆ RST : RESET Switch | |
|----------------------|-------------|
| Pin No. | Function |
| 1 | RESET Input |
| 2 | GND |

| ◆ PWR : POWER ON LED (PW-LED) | |
|--------------------------------|---------------|
| Pin No. | Function |
| 1 | LED POWER (+) |
| 2 | NC |
| 3 | GND |

| ◆ Slot 1 | |
|-------------------------------------|--|
| For Pentium® II processor installed | |

| ◆ SPK : SPEAKER Connector | |
|---------------------------|----------|
| Pin No. | Function |
| 1 | VCC |
| 2 | NC. |
| 3 | NC. |
| 4 | Output |

| ◆ Soft PWR : Soft Power Switch | |
|--------------------------------|-------------|
| Pin No. | Function |
| 1 | CTRL-Signal |

| | |
|---|-----|
| 2 | GND |
|---|-----|

3.4. DRAM INSTALLATION

The mainboard can be installed with 4 / 8 / 16 / 32 / 64 / 128 / 256 MB 168 pins DIMM module DRAM, and the DRAM speed must be 50 or 60 ns for EDO & 67~100 MHz for SDRAM. The DRAM memory system on mainboard consists of bank 0, 1, 2 & bank 3.

Since 168 pins DIMM module is 64 bits width, using 1 PCS which can match a 64 bits system. The total memory size is 8 MB ~ 1 GB EDO / 512MB SDRAM. The DRAM installation position refer to Figure 3.1, and notice the Pin 1 of DIMM module must match with the Pin 1 of DIMM socket. Insert the DRAM DIMM module into the DIMM socket at Vertical angle. If there is a wrong direction of Pin 1, the DRAM DIMM module couldn't be inserted into socket completely.

3.5. CPU SPEED SETUP

The system's speed is fixed to 66.6MHz. The user can change the DIP SWITCH (**SW**) selection to set up the CPU speed for 200 - 366MHz processor. The CPU speed must match with the frequency RATIO. It will cause system hanging up if the frequency RATIO is higher than CPU's.

| DIP SWITCH (SW) | | | | FREQ. RATIO | EXT.CLK. MHz | INT.CLK. MHz | CPU Type |
|-----------------|-----|-----|-----|----------------|-----------------|-----------------|---------------------|
| 1 | 2 | 3 | 4 | | | | |
| OFF | ON | OFF | OFF | 3 | 66 | 200 | Pentium® II 200 MHz |
| ON | ON | OFF | OFF | 3.5 | 66 | 233 | Pentium® II 233 MHz |
| OFF | OFF | ON | OFF | 4 | 66 | 266 | Pentium® II 266 MHz |
| ON | OFF | ON | OFF | 4.5 | 66 | 300 | Pentium® II 300 MHz |
| OFF | ON | ON | OFF | 5 | 66 | 333 | Pentium® II 333 MHz |
| ON | ON | ON | OFF | 5.5 | 66 | 366 | Pentium® II 366 MHz |

⚡* The CPU is a sensitive electric component and it can be easily damaged by static electricity, so users must keep it away from metal

surface when the CPU is installed onto mainboard.

3.6. CMOS RTC & ISA CFG CMOS SRAM

There're RTC & CMOS SRAM on board; they have a power supply from external battery to keep the DATA inviolate & effective. The RTC is a REAL-TIME CLOCK device, which provides the DATE & TIME to system. The CMOS SRAM is used for keeping the information of system configuration, so the system can automatically boot OS every time. Since the lifetime of internal battery is 5 years, the user can change a new Battery to replace old one after it cannot work.

3.7. SPEAKER CONNECTOR INSTALLATION

There is a speaker in AT system for sound purpose. The 4 - Pins connector SPK is used to connect speaker.

3.8. HARDWARE RESET SWITCH CONNECTOR INSTALLATION

The RESET switch on panel provides users with HARDWARE RESET function. The system will do a cold start after the RESET switch is pushed and released by user. The RESET switch is a 2 PIN connector and should be installed to **RST** on mainboard.

3.9. POWER LED CONNECTOR INSTALLATION

System has power LED lamp on the panel of case. The power LED will light on off or flash to indicate which step on the system. The connector should be connected to PWR of mainboard in correct direction.

3.10. IDE & ATAPI DEVICE INSTALLATION

There are two-Enhanced PCI IDE ports (**IDE1**, **IDE2**) on board, which following ATAPI standard SPEC. Any one IDE port can connected to two ATAPI devices (IDE Hard Disk, CD-ROM & Tape Driver), so total four ATAPI devices can exist in a system. The **HD** is the active LED port for ATAPI

devices.

3.11. SCSI DEVICE INSTALLATION

There are two SCSI ports on board, One is 8bit SCSI port for SCSI-2 or ULTRA SCSI device, and total 7 8bit SCSI devices can exist in a system.

The other is 16bit SCSI port for wide or ULTRA Wide SCSI device, and total 15 SCSI devices (include 8bit SCSI device) can exist in a system.

The low byte terminator (used for 8bit SCSI port) and high byte terminator (used for Wide SCSI port) turning "ON" or "OFF" are controlled by BIOS SETUP (in the INTEGRATED PERIPHERALS SETUP PAGE).

Terminator ON/OFF rules

CASE 1: BIOS SETUP (SCSI Terminator Enable: Both)

① System has 16 bit SCSI

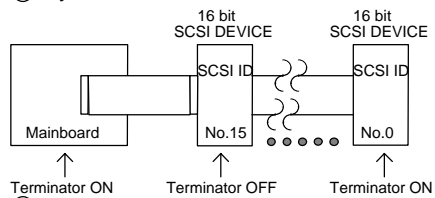

② System has only 8 bit SCSI device

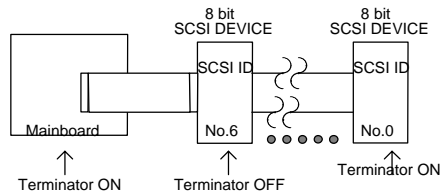

③ System has EXT. SCSI port but has not INT. SCSI device

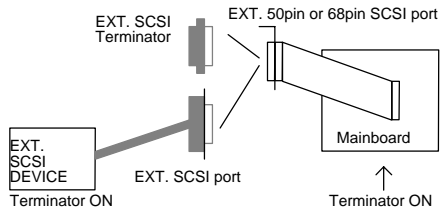

CASE 2: BIOS SETUP (SCSI Terminator Enable: High Byte)

① System has 16 bit & 8 bit SCSI device

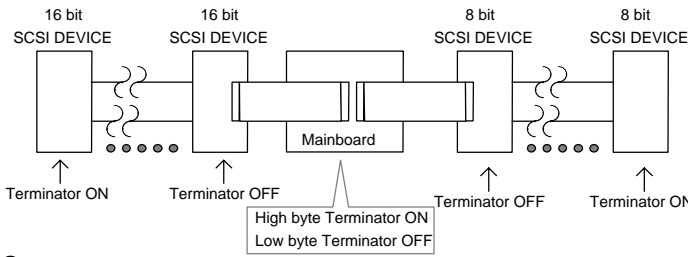

② System has 8 bit EXT. SCSI port & 8 bit INT. SCSI device

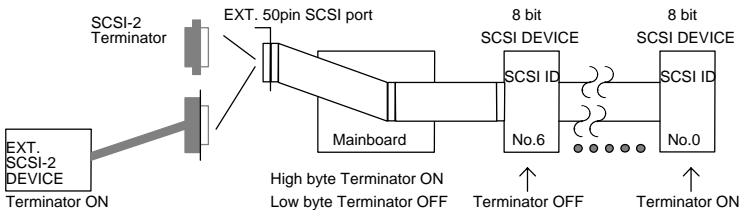

③ System has 8 bit EXT. SCSI port & 16 bit INT. SCSI device

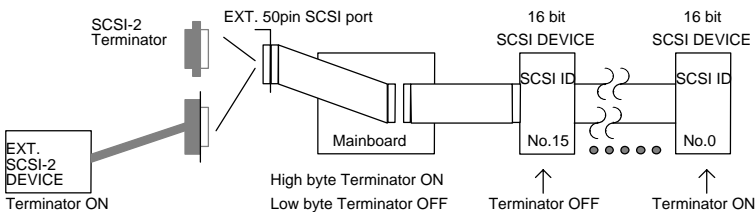

④ System has 16 bit EXT. SCSI port & 8 bit INT. SCSI device

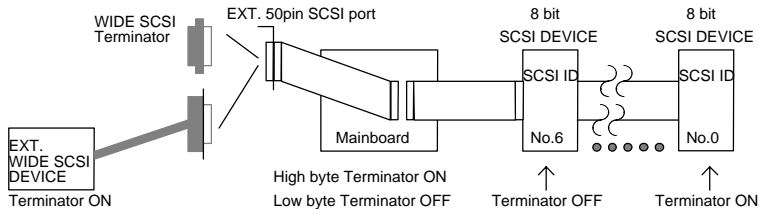

CASE 3: BIOS SETUP (SCSI Terminator Enable: None)

① System has 16 bit EXT. SCSI port & INT. 16 bit SCSI device

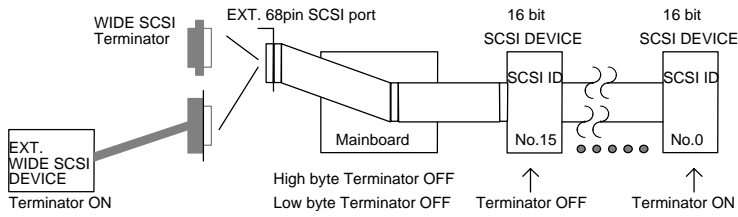

3.12. PERIPHERAL DEVICE INSTALLATION

After the I/O device installation and jumpers setup, the mainboard can be mounted into the case and fixed by screw. To complete the mainboard installation, the peripheral device could be installed now. The basic system needs a display interface card. If the PCI - Bus device is to be installed in the system, any one of four PCI - Bus slots can be used.

3.13. KEYBOARD & PS/2 MOUSE INSTALLATION

The main board supports PS/2 Mouse (**J1**). The BIOS will auto detect whether the PS/2 Mouse is installed or not & assign IRQ12 for PS/2 Mouse port if it is installed. After installing the peripheral device, the user should check everything again, and prepare to power-on the system.

4. BIOS CONFIGURATION

Award's BIOS ROM has a built-in Setup program that allows users to modify the basic system configuration. This type of information is stored in battery-backed CMOS SRAM so that it retains the Setup information when the power is turned off.

4.1. ENTERING SETUP

Power ON the computer and press immediately will allow you to enter Setup. If the message disappears before you respond and you still wish to enter Setup, restart the system to try again by turning it OFF then ON or pressing the "RESET" bottom on the system case. You may also restart by simultaneously press <Ctrl>, <Alt>, and keys.

4.2. CONTROL KEYS

| | |
|-------------|---|
| Up arrow | Move to previous item |
| Down arrow | Move to next item |
| Left arrow | Move to the item in the left hand |
| Right arrow | Move to the item in the right hand |
| Esc key | Main Menu - Quit and not save changes into CMOS Status Page Setup Menu and Option Page Setup Menu - Exit current page and return to Main Menu |
| PgUp key | Increase the numeric value or make changes |
| PgDn key | Decrease the numeric value or make changes |
| F1 key | General help, only for Status Page Setup Menu and Option Page Setup Menu |
| F2 key | Change color from total 16 colors |
| F3 key | Reserved |
| F4 key | Reserved |
| F5 key | Restore the previous CMOS value from CMOS, only for Option Page Setup Menu |
| F6 key | Load the default CMOS value from BIOS default table, only for Option Page Setup Menu |
| F7 key | Load the default |
| F8 key | Reserved |
| F9 key | Reserved |
| F10 key | Save all the CMOS changes, only for Main Menu |

4.3. GETTING HELP

4.3.1. Main Menu

The on-line description of the highlighted setup function is displayed at the bottom of the screen.

4.3.2. Status Page Setup Menu / Option Page Setup Menu

Press F1 to pop up a small help window that describes the appropriate keys to use and the possible selections for the highlighted item. To exit the Help Window press <Esc>.

4.4. THE MAIN MENU

Once you enter Award BIOS CMOS Setup Utility, the Main Menu (Figure 4.1) will appear on the screen. The Main Menu allows you to select from nine setup functions and two exit choices. Use arrow keys to select among the items and press <Enter> to accept or enter the sub-menu.

ROM PCI / ISA BIOS
CMOS SETUP UTILITY
AWARD SOFTWARE, INC.

| | |
|---------------------------------|--------------------------|
| STANDARD CMOS SETUP | USER PASSWORD |
| BIOS FEATURES SETUP | IDE HDD AUTO DETECTION |
| CHIPSET FEATURES SETUP | SAVE & EXIT SETUP |
| POWER MANAGEMENT SETUP | EXIT WITHOUT SAVING |
| PNP/PCI CONFIGURATION | |
| INTEGRATED PERIPHERALS | |
| LOAD SETUP DEFAULTS | |
| ESC : Quit | ↑ ↓ → ← : Select Item |
| F10 : Save & Exit Setup | (Shift)F2 : Change Color |
| Time, Date, Hard Disk Type, ... | |

Figure 4.1: Main Menu

- Standard CMOS setup
This setup page includes all the items in standard compatible BIOS.
- BIOS features setup
This setup page includes all the items of Award special enhanced features.
- Chipset features setup
This setup page includes all the items of chipset special features.
- Power management setup
This setup page includes all the items of Green function features.
- PNP/PCI configuration
This setup page includes all the configurations of PCI & PnP ISA resources.
- Integrated peripherals
This setup page includes all onboard peripherals.
- Load setup defaults
Setup Defaults indicates the most appropriate value of the system parameters which the system would be in safe configuration.
- User password
Change, set, or disable password. It allows you to limit access to the system and Setup, or just to Setup.
- IDE HDD auto detection
Automatically configure hard disk parameters.
- Save & exit setup
Save CMOS value settings to CMOS and exit setup.
- Exit without saving
Abandon all CMOS value changes and exit setup.

4.5. STANDARD CMOS SETUP MENU

The items in Standard CMOS Setup Menu (Figure 4.2) are divided into 9 categories. Each category includes no, one or more than one setup items. Use the arrows to highlight the item and then use the <PgUp> or <PgDn> keys to select the value you want in each item.

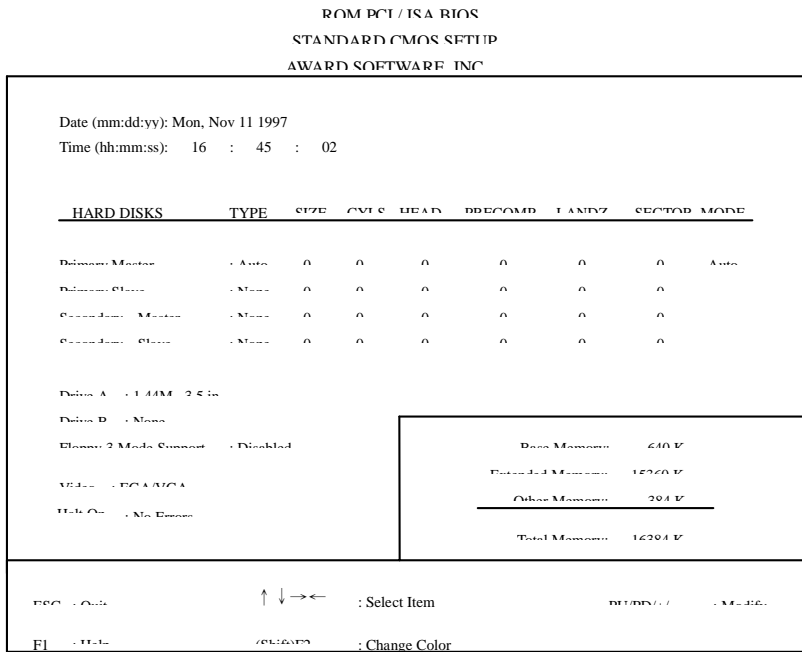

Figure 4.2: Standard CMOS Setup Menu

- Date

The date format is <day>, <month> <date> <year>.

| | |
|-------|--|
| day | The day, from Sun to Sat, determined by the BIOS and is display-only |
| month | The month, Jan. through Dec. |
| date | The date, from 1 to 31 (or the maximum allowed in the month) |

| | |
|------|----------------------------------|
| year | The year, from 1994 through 2079 |
|------|----------------------------------|

- Time

The times format in <hour> <minute> <second>. The time is calculated base on the 24-hour military-time clock. For example, 1 p.m. is 13:00:00.

- Primary HDDs / Secondary HDDs

The category identifies the types of hard disk from drive C to F that has been installed in the computer. There are two types: auto type, and user definable type. User type is user-definable; Auto type which will automatically detect HDD type.

Note that the specifications of your drive must match with the drive table. The hard disk will not work properly if you enter improper information for this category.

If you select User Type, related information will be asked to enter to the following items. Enter the information directly from the keyboard and press <Enter>. Such information should be provided in the documentation form your hard disk vendor or the system manufacturer.

| | |
|----------|---------------------|
| CYLS. | Number of cylinders |
| HEADS | number of heads |
| PRECOMP | write precomp |
| LANDZONE | Landing zone |
| SECTORS | number of sectors |

If a hard disk has not been installed select NONE and press <Enter>.

- Drive A type / Drive B type

The category identifies the types of floppy disk drive A or drive B that has been installed in the computer.

| | |
|----------------|---|
| None | No floppy drive installed |
| 360K, 5.25 in. | 5.25 inch PC-type standard drive; 360K byte capacity. |
| 1.2M, 5.25 in. | 5.25 inch AT-type high-density drive; 1.2M byte capacity (3.5 inch when 3 Mode is Enabled). |
| 720K, 3.5 in. | 3.5 inch double-sided drive; 720K byte capacity |
| 1.44M, 3.5 in. | 3.5 inch double-sided drive; 1.44M byte capacity. |

| | |
|----------------|---|
| 2.88M, 3.5 in. | 3.5 inch double-sided drive; 2.88M byte capacity. |
|----------------|---|

- Floppy 3 Mode Support (for Japan Area)

| | |
|----------|---------------------------------------|
| Disabled | Normal Floppy Drive. |
| Drive A | Drive A is 3 mode Floppy Drive. |
| Drive B | Drive B is 3 mode Floppy Drive. |
| Both | Drive A & B are 3 mode Floppy Drives. |

- Video

The category detects the type of adapter used for the primary system monitor that must match your video display card and monitor. Although secondary monitors are supported, you do not have to select the type in setup.

| | |
|---------|---|
| EGA/VGA | Enhanced Graphics Adapter/Video Graphics Array. For EGA, VGA, SVGA, or PGA monitor adapters |
| CGA 40 | Color Graphics Adapter, power up in 40 column mode |
| CGA 80 | Color Graphics Adapter, power up in 80 column mode |
| MONO | Monochrome adapter, includes high resolution monochrome adapters |

- Halt on

The category determines whether the computer will stop if an error is detected during power up.

| | |
|-------------------|---|
| NO Errors | The system boot will not stop for any error that may be detected |
| All Errors | Whenever the BIOS detects a non-fatal error the system will be stopped and you will be prompted |
| All, But Keyboard | The system boot will not stop for a keyboard error; it will stop for all other errors |
| All, But Diskette | The system boot will not stop for a disk error; it will stop for all other errors |
| All, But Disk/Key | The system boot will not stop for a keyboard or |

| | |
|--|---|
| | disk error; it will stop for all other errors |
|--|---|

- **Memory**

The category is display-only which is determined by POST (Power On Self Test) of the BIOS.

Base Memory

The POST of the BIOS will determine the amount of base (or conventional) memory installed in the system.

The value of the base memory is typically 512 K for systems with 512 K memory installed on the motherboard, or 640 K for systems with 640 K or more memory installed on the motherboard.

Extended Memory

The BIOS determines how much extended memory is present during the POST.

This is the amount of memory located above 1 MB in the CPU's memory address map.

Expanded Memory

Expanded Memory in memory defined by the Lotus/Intel/Microsoft (LIM) standard as EMS.

Many standard DOS applications can not utilize memory above 640 K; the Expanded Memory Specification (EMS) swaps memory, which not utilized by DOS with a section, or frame, so these applications, can access all of the system memory.

Memory can be swapped by EMS is usually 64 K within 1 MB or memory above 1 MB, depends on the chipset design.

Expanded memory device driver is required to use memory as Expanded Memory.

Other Memory

This refers to the memory located in the 640 K to 1024 K address space. This is memory that can be used for different applications.

DOS uses this area to load device drivers to keep as much base memory free for application programs. Most use for this area is Shadow RAM.

4.6. BIOS FEATURES SETUP

ROM PCI / ISA BIOS
BIOS FEATURES SETUP
AWARD SOFTWARE INC

| | | | |
|----------------------------|------------|----------------------------|-----------------------|
| Virus Warning | · Disabled | Video BIOS Shadow | · Enabled |
| CPU Internal Cache | · Enabled | C8000 - C9FFF Shadow | · Disabled |
| External Cache | · Enabled | CA000 - CAFFF Shadow | · Disabled |
| CPU L2 Cache ECC Checking | · Disabled | D0000 - D3FFF Shadow | · Disabled |
| Quick Power On Self Test | · Enabled | D4000 - D7FFF Shadow | · Disabled |
| CPU Update Data | · Enabled | D8000 - DBFFF Shadow | · Disabled |
| Root Sequence | · A C SCSI | DC000 - DFFFF Shadow | · Disabled |
| Swan Floppy Drive | · Disabled | | |
| Root Un Floppy Seek | · Enabled | | |
| Root Un NumLock Status | · On | | |
| Typematic Rate Setting | · Disabled | | |
| Typematic Rate (Chars/Sec) | · 6 | | |
| Typematic Delay (Msec) | · 250 | F5C · Quit | ↑ ↓ → ← · Select Item |
| Security Option | · Setup | F1 · Help | Del/Prt/+/= · Modify |
| PCI/VGA Palette Snoop | · Disabled | F5 · Old Values (Shift+F2) | · Color |
| OS Select For DRAM >64MB | · Non-OS2 | F7 · Load Setup Defaults | |

Figure 4.3: BIOS Features Setup

- Virus Warning

If it is set to enable, the category will flash on the screen when there is any attempt to write to the boot sector or partition table of the hard disk drive. The system will halt and the following error message will appear in the mean time. You can run anti-virus program to locate the problem.

Default value is Disabled.

| | |
|----------|---|
| Enabled | Activate automatically when the system boots up causing a warning message to appear when anything attempts to access the boot sector or hard disk partition table |
| Disabled | No warning message to appear when anything attempts to access the boot sector or hard disk partition table |

- CPU Internal Cache / External Cache

These two categories speed up memory access. However, it depends on CPU / chipset design. The default value is Enabled.

| | |
|----------|---------------|
| Enabled | Enable cache |
| Disabled | Disable cache |

- CPU L2 Cache ECC Checking

The default value is Disabled.

| | |
|----------|-----------------------------------|
| Enabled | Enable CPU L2 Cache ECC Checking |
| Disabled | Disable CPU L2 Cache ECC Checking |

- Quick Power On Self Test

This category speeds up Power On Self Test (POST) after you power on the computer. If it is set to Enable, BIOS will shorten or skip some check items during POST.

The default value is Enabled.

| | |
|----------|-------------------|
| Enabled | Enable quick POST |
| Disabled | Normal POST |

- CPU Update Data

The default value is Enabled.

| | |
|----------|------------------------|
| Enabled | Enable CPU Update Data |
| Disabled | Normal CPU Update Data |

- Boot Sequence

This category determines which drive computer searches first for the disk operating system (i.e., DOS). Default value is A, C, SCSI.

| | |
|------------|---|
| X1, X2, X3 | System will first search for X1 disk drive then X2 disk drive and then X3 disk drive. |
|------------|---|

- Swap Floppy Drive

The default value is Disabled.

| | |
|----------|--|
| Enabled | Floppy A & B will be swapped under DOS |
| Disabled | Floppy A & B will be normal definition |

- **Boot Up Floppy Seek**

During POST, BIOS will determine the floppy disk drive installed is 40 or 80 tracks. 360 K type is 40 tracks 720 K, 1.2 M and 1.44 M are all 80 tracks. The default value is Enabled.

| | |
|----------|--|
| Enabled | BIOS searches for floppy disk drive to determine it is 40 or 80 tracks. Note that BIOS can not tell from 720 K, 1.2 M or 1.44 M drive type as they are all 80 tracks |
| Disabled | BIOS will not search for the type of floppy disk drive by track number. Note that there will not be any warning message if the drive installed is 360 K |

- **Boot Up NumLock Status**

The default value is On.

| | |
|-----|-----------------------|
| On | Keypad is number keys |
| Off | Keypad is arrow keys |

- **Typematic Rate Setting**

The default value is Disabled.

| | |
|----------|--|
| Enabled | Enable Keyboard Typematic rate setting. |
| Disabled | Disable Keyboard Typematic rate setting. |

- **Typematic Rate (Chars / Sec)**

The default value is 6.

| | |
|------|--|
| 6-30 | Set the maximum Typematic rate from 6 chars. Per second to 30 chars. Per second. |
|------|--|

- **Typematic Delay (Msec)**

The default value is 250.

| | |
|----------|--|
| 250-1000 | Set the time delay from first key to repeat the same key in to computer. |
|----------|--|

- Security Option

This category allows you to limit access to the system and Setup, or just to Setup. The default value is Setup.

| | |
|--------|--|
| System | The system can not boot and can not access to Setup page will be denied if the correct password is not entered at the prompt |
| Setup | The system will boot, but access to Setup will be denied if the correct password is not entered at the prompt |

- **To disable security, select PASSWORD SETTING at Main Menu and then you will be asked to enter password. Do not type anything and just press <Enter>, it will disable security. Once the security is disabled, the system will boot and you can enter Setup page freely.**

- PCI/VGA Palette Snoop

The default value is Disabled.

| | |
|----------|---|
| Enabled | For having Video Card on ISA Bus and VGA Card on PCI Bus. |
| Disabled | For VGA Card only. |

- OS Select For DRAM>64MB

The default value is Non-OS2.

| | |
|---------|---|
| Non-OS2 | Using non-OS2 operating system. |
| OS2 | Using OS2 operating system and DRAM>64MB. |

- Video BIOS Shadow

It determines whether video BIOS is able to copy to RAM, however, it is optional from chipset design. Video Shadow will increase the video speed. The default value is Enabled.

| | |
|----------|--------------------------|
| Enabled | Video shadow is enabled |
| Disabled | Video shadow is disabled |

- C8000 - CFFFF Shadow / D0000 - DFFFF Shadow

These categories determine whether optional ROM will be copied to RAM by 16 K byte. The default value are Disabled.

| | |
|----------|-----------------------------|
| Enabled | Optional shadow is enabled |
| Disabled | Optional shadow is disabled |

4.7. CHIPSET FEATURES SETUP

ROM BIOS / ISA BIOS
CHIPSET FEATURES SETUP
AWARD SOFTWARE, INC.

| | | | |
|--------------------------|------------|---------------------------|-----------------------|
| Auto Configuration | : Enabled | CPU Temperature Select | : 70 °C / 158 °F |
| DRAM Speed Selection | : Normal | Slow Down CPU Duty Cycle | : Normal |
| Memory Ruffler Strength | : Middle | Alarm When CPU Overheat | : Disabled |
| DRAM Data Integrity Mode | : Non-ECC | CPU Fan Failure Control | : Disabled |
| Video RAM Cacheable | : Disabled | Current CPU Temperature | : Normal |
| 16 Bit I/O Recovery Time | : 1 | Current CPU Fan Status | : V V V V |
| Memory Hole At 15M-16M | : Disabled | Current +12V Voltage | : OK |
| Delayed Transaction | : Disabled | Current +12V Voltage | : OK |
| SDRAM RAS to CAS Delay | : Fast | Current +5V Voltage | : OK |
| SDRAM RAS Discharge Time | : Fast | Current -5V Voltage | : OK |
| SDRAM CAS Latency Time | : 2 | Current Battery Life | : OK |
| | | CPU VCore Voltage | : 0.8V |
| | | F5C : Quit | ↑ ↓ → ← : Select Item |
| | | F1 : Help | PII/PD/+/=: Modify |
| | | F5 : Old Values (Shift)F7 | : Color |
| | | F7 : Load Setup Defaults | |

Figure 4.4: Chipset Features Setup

- Auto Configuration

The default value is Enabled.

| | |
|----------|--------------------------------|
| Enabled | For 50 - 60ns EDO DRAM Timing. |
| Disabled | For slow speed DRAM Timing. |

- DRAM Speed Selection

The default value is Normal.

| | |
|--------|------------------------------------|
| Normal | For normal DRAM operation. |
| Fast | For Fastest DRAM timing operation. |

- Memory Buffer Strength

The default value is Middle.

| | |
|--------|------------------------------------|
| Middle | For Middle Memory Buffer strength. |
| Low | For Low Memory Buffer strength. |
| High | For High Memory Buffer strength. |

- DRAM Data Integrity Mode

The default value is Non-ECC.

| | |
|---------|--------------------------------------|
| Non-ECC | For 64bit standard type DIMM module. |
| ECC | For 72bit ECC type DIMM module. |

- Video RAM Cacheable

The default value is Disabled.

| | |
|----------|---|
| Disabled | Disable this function. |
| Enabled | Enable this function to get better VGA performance; while some brands of VGA must be disabled this function (e.g.ET4000W32P). |

- 16 Bit I/O Recovery Time

The default value is 1.

| | |
|-----|---|
| 1-4 | Set 16 Bit I/O recovery time from 1 to 4. |
| NA | None. |

- Memory Hole At 15M-16M

The default value is Disabled.

| | |
|----------|---------------------------------------|
| Disabled | Normal Setting. |
| Enabled | Set Address=15~16MB remap to ISA BUS. |

- Delayed Transaction

The default value is Disabled.

| | |
|----------|--------------------------------------|
| Disabled | Normal operation. |
| Enabled | For slow speed ISA device in system. |

- SDRAM RAS-to-CAS Delay

The default value is Fast

| | |
|------|------------------------------------|
| Slow | For 67 / 83 MHz SDRAM DIMM module. |
| Fast | For 100 MHz SDRAM DIMM module. |

- SDRAM RAS Precharge Time

The default value is Fast.

| | |
|------|------------------------------------|
| Slow | For 67 / 83 MHz SDRAM DIMM module. |
| Fast | For 100 MHz SDRAM DIMM module. |

- SDRAM CAS latency Time

The default value is 2.

| | |
|---|------------------------------------|
| 3 | For 67 / 83 MHz SDRAM DIMM module. |
| 2 | For 100 MHz SDRAM DIMM module. |

- CPU Temperature Select

The default value is 70°C / 158°F.

| | |
|--------------|--|
| 65°C / 149°F | Monitor CPU Temp. at 65°C / 149°F, if Temp. > 65°C / 149°F will cause system alarming & slow down CPU speed. |
| 70°C / 158°F | Monitor CPU Temp. at 70°C / 158°F, if Temp. > 70°C / 158°F will cause system alarming & slow down CPU speed. |
| 75°C / 167°F | Monitor CPU Temp. at 75°C / 167°F, if Temp. > 75°C / 167°F will cause system alarming & slow down CPU speed. |
| 80°C / 176°F | Monitor CPU Temp. at 80°C / 176°F, if Temp. > 80°C / 176°F will cause system alarming & slow down CPU speed. |
| Disabled | Disable monitors CPU Temp. (Overheat) function. |

- Slow Down CPU Duty Cycle

The default value is Normal.

| | |
|--------|---|
| Normal | Set Slow Down CPU Duty Cycle to Normal. |
| 12.5% | Set Slow Down CPU Duty Cycle to 12.5%. |
| 25.0% | Set Slow Down CPU Duty Cycle to 25.5%. |
| 37.5% | Set Slow Down CPU Duty Cycle to 37.5%. |
| 50.0% | Set Slow Down CPU Duty Cycle to 50.0%. |
| 62.5% | Set Slow Down CPU Duty Cycle to 62.5%. |
| 75.0% | Set Slow Down CPU Duty Cycle to 75.0%. |

- Alarm When CPU Overheat

The default value is Disabled.

| | |
|----------|------------------------------|
| Disabled | Disable Alarm When Overheat. |
| Enabled | Enable Alarm When Overheat . |

- CPU Fan Failure Control

The default value is Disabled.

| | |
|----------|---|
| Disabled | Disable monitor CPU FAN working status. |
| Enabled | Enable monitor CPU FAN working status. |

- Current CPU Temperature

The default value is Normal

| | |
|--------|--|
| High | CPU overheats. (CPU Temperature is out of SPEC.) |
| Normal | CPU Temp. is in SPEC. |

- Current CPU Fan Status

The default value depends on system monitoring CPU FAN status.

| | |
|------|-----------------------------|
| Fail | The CPU FAN fails to work. |
| OK | The CPU FAN works normally. |
| XXXX | Ignore |

- Current $\pm 12V$ / $\pm 5V$ Voltages

The default value depends on system monitoring $\pm 12V$ / $\pm 5V$ voltage status.

| | |
|------|--|
| Fail | The $\pm 12V$ / $\pm 5V$ voltage from Power supply is out of SPEC. |
| OK | The $\pm 12V$ / $\pm 5V$ voltage from Power supply is in SPEC. |

- Current Battery Life

The default value depends on system monitoring Battery status.

| | |
|------|--|
| Fail | The Battery (3V) voltage is out of SPEC. |
| OK | The Battery (3V) voltage is in SPEC. |

- CPU VCore Voltage

| | |
|-----------|---|
| 1.8V~3.5V | The voltage is current setting for CPU. |
|-----------|---|

4.8. POWER MANAGEMENT SETUP

ROM PCI/ISA BIOS
POWER MANAGEMENT SETUP
AWARD SOFTWARE INC.

| | |
|--|---|
| Power Management · Enable PM Control by APM · Yes Suspend Mode · Disable HDD Power Down · Disable Suspend Mode option · Power On Suspend VGA Active Monitor · Disabled Soft off by DWD/RTN · Instant off CPU/FAN off In Suspend · Disabled Resume by Alarm · Disabled * Date (of Month) Alarm : 0 * Time (hh:mm:ss) Alarm : 00:00:00 | ** De-load Global Timer Events * IRQ (3,7,9,15) NMI · Enabled Primary IDE 0 · Disabled Primary IDE 1 · Disabled Secondary IDE 0 · Disabled Secondary IDE 1 · Disabled Floppy Disk · Enabled Serial Port · Enabled Parallel Port · Disabled F5C - Quit ↑ ↓ → ← · Select Item F1 - Help DH/DH/+/L · Modify F5 - Old Values (Shift)F2 · Color F7 - Load Setup Defaults |
|--|---|

Figure 4.5: Power Management Setup

* These two items will show up when Resume by Alarm is enabled.

- Power Management

The default value is Enabled.

| | |
|----------|-------------------------|
| Enabled | Enable Green function. |
| Disabled | Disable Green function. |

- PM Control by APM

The default value is Yes.

| | |
|-----|--------------------------------|
| Yes | Enable software APM function. |
| No | Disable software APM function. |

- Suspend Mode

The default value is Disable.

| | |
|----------------|--|
| Disabled | Disable Suspend Mode. |
| 1 min - 1 Hour | Setup the timer to enter Suspend Mode. |

- HDD Power Down

The default value is Disable.

| | |
|------------|--|
| Disable | Disable HDD Power Down mode function. |
| 1-15 mins. | Enable HDD Power Down mode between 1 to 15 mins. |

- Suspend Mode Option

The default value is PowerOn Suspend

| | |
|-----------------|--|
| PowerOn Suspend | Set the system to PowerOn Suspend mode |
| Suspend to Disk | Set the system to Suspend to Disk mode |

- VGA Active Monitor

The default value is Disabled.

| | |
|----------|-------------------------------|
| Disabled | Disable monitor VGA activity. |
| Enabled | Enable monitor VGA activity. |

- Soft-off by PWR-BTTN

The default value is Instant-Off.

| | |
|--------------|-------------------------------------|
| Instant-off | Soft switch ON/OFF for POWER ON/OFF |
| Delay 4 Sec. | Soft switch ON 4sec. for POWER OFF. |

- CPUFAN Off In Suspend

The default value is Disabled.

| | |
|----------|--|
| Disabled | Disable this function. |
| Enabled | Stop CPU FAN when entering Suspend mode. |

- Resume by Alarm

The default value is Disabled.

| | |
|----------|---|
| Disabled | Disable this function. |
| Enabled | Enable alarm function to POWER ON system. |

If the default value is Enabled.

| | |
|-------------------------------|--------------------------|
| Date (of Month) Alarm : | 0~31 |
| Time (hh: mm: ss) Alarm : | (0~23) : (0~59) : (0~59) |

- IRQ [3-7,9-15] , NMI

The default value is Enabled.

| | |
|----------|--|
| Disabled | Disable this function. |
| Enabled | Enable monitor IRQ [3-7,9-15] for Green event. |

- Primary IDE 0/1

The default value is Disabled.

| | |
|----------|---|
| Disabled | Disable this function. |
| Enabled | Enable monitor Primary IDE 0/1 for Green event. |

- Secondary IDE 0/1

The default value is Disabled.

| | |
|----------|------------------------|
| Disabled | Disable this function. |
|----------|------------------------|

| | |
|---------|---|
| Enabled | Enable monitor Secondary IDE 0/1 for Green event. |
|---------|---|

- Floppy Disk

The default value is Enabled.

| | |
|----------|---|
| Disabled | Disable this function. |
| Enabled | Enable monitor Floppy Disk for Green event. |

- Serial Port

The default value is Enabled.

| | |
|----------|---|
| Disabled | Disable this function. |
| Enabled | Enable monitor Serial Port for Green event. |

- Parallel Port

The default value is Disabled.

| | |
|----------|---|
| Disabled | Disable this function. |
| Enabled | Enable monitor Parallel Port for Green event. |

4.9. PNP/PCI CONFIGURATION

ROM PCI / ISA BIOS
 PNP/PCI CONFIGURATION
 AWARD SOFTWARE, INC.

| | | | |
|--------------------------|---------------|--------------------------|-----------------------|
| PNP OS Installed | : No | Used MEM base addr | : N/A |
| Resources Controlled by | : Manual | *Used MEM Length | : 8K |
| Reset Configuration Data | : Disabled | | |
| IRQ-3 assigned to | : Legacy ISA | | |
| IRQ-4 assigned to | : Legacy ISA | | |
| IRQ-5 assigned to | : PCI/ISA PnP | | |
| IRQ-7 assigned to | : Legacy ISA | | |
| IRQ-9 assigned to | : PCI/ISA PnP | | |
| IRQ-10 assigned to | : PCI/ISA PnP | | |
| IRQ-11 assigned to | : PCI/ISA PnP | | |
| IRQ-12 assigned to | : Legacy ISA | | |
| IRQ-14 assigned to | : Legacy ISA | | |
| IRQ-15 assigned to | : Legacy ISA | | |
| DMA-0 assigned to | : PCI/ISA PnP | | |
| DMA-1 assigned to | : PCI/ISA PnP | | |
| DMA-3 assigned to | : PCI/ISA PnP | ESC : Quit | ↑ ↓ → ← : Select Item |
| DMA-5 assigned to | : PCI/ISA PnP | F1 : Help | PU/PD/+/- : Modify |
| DMA-6 assigned to | : PCI/ISA PnP | F5 : Old Values | (Shift)F2 : Color |
| DMA-7 assigned to | : PCI/ISA PnP | F7 : Load Setup Defaults | |

Figure 4.6: PCI Slot Configuration

* This item will show up when Used MEM base addr has been set.

- PNP OS Installed

The default value is No.

| | |
|-----|------------------------------------|
| Yes | Enable PNP OS Installed function. |
| No | Disable PNP OS Installed function. |

- Resources Controlled by

The default value is Manual.

| | |
|--------|--|
| Manual | User can set the PnP resource (I/O Address, IRQ & DMA channels) used by legacy ISA DEVICE. |
| Auto | BIOS automatically use these PnP rescuers. |

- Reset Configuration Data

The default value is Disabled.

| | |
|----------|---------------------------------------|
| Disabled | Disable this function. |
| Enabled | Enable clear PnP information in ESCD. |

- IRQ (3,4,5,7,9,10,11,12,14,15), DMA(0,1,3,5,6,7) assigned to

The default value is "Legacy ISA" or "PCI/ISA PnP".

| | |
|-------------|--|
| Legacy ISA | The resource is used by Legacy ISA device. |
| PCI/ISA PnP | The resource is used by PCI/ISA PnP device (PCI or ISA). |

- Used MEM base addr

The default value is N/A.

| | |
|-------------|---|
| N/A | Disable the MEM. block using. |
| C800 ~ DC00 | Select the MEM. block starting address. |

- Used MEM Length

The default value is 8K.

| | |
|----------|-----------------------------|
| 8K ~ 64K | Select the MEM. block size. |
|----------|-----------------------------|

4.10. INTEGRATED PERIPHERALS

ROM PCI / ISA BIOS
INTEGRATED PERIPHERALS
AWARD SOFTWARE INC

| | | | |
|---------------------------|------------|-------------------------|-----------------------|
| IDE HDD Block Mode | · Enabled | PS/2 Mouse Power On | · Disabled |
| IDE Primary Master PIO | · Auto | Keyboard Power On | · Disabled |
| IDE Primary Slave PIO | · Auto | ** KB Power On Multikey | · Enter |
| IDE Secondary Master PIO | · Auto | | |
| IDE Secondary Slave PIO | · Auto | | |
| IDE Primary Master UDMA | · Auto | | |
| IDE Primary Slave UDMA | · Auto | | |
| IDE Secondary Master UDMA | · Auto | | |
| IDE Secondary Slave UDMA | · Auto | | |
| On-Chip Primary PCI IDE | · Enabled | | |
| On-Chip Secondary PCI IDE | · Enabled | | |
| Onboard PCI SCSI chip | · Enabled | | |
| SCSI Terminator Enable | · Both | | |
| USB Keyboard Support | · Disabled | | |
| Onboard EDC Controller | · Enabled | | |
| Onboard Serial Port1 | · 2E8/IRQ4 | F5C · Quit | ↑ ↓ → ← · Select Item |
| Onboard Serial Port2 | · 2E8/IRQ2 | F1 · Help | PF1/PFN/▲/▼ · Modify |
| Onboard Parallel Port | · 278/IRQ7 | F5 · Old Value | (Shift)E7 · Color |
| Parallel Port Mode | · SPP | F7 · Load Same Defaults | |

Figure 4.7: Load Setup Defaults

** This item will show up when "Keyboard Power On: Multikey" is selected.

- IDE HDD Block Mode

The default value is Enabled.

| | |
|----------|----------------------------|
| Enabled | Enable IDE HDD Block Mode |
| Disabled | Disable IDE HDD Block Mode |

- IDE Primary Master PIO (for onboard IDE 1st channel).

The default value is Auto.

| | |
|---------|--|
| Auto | BIOS will automatically detect the IDE HDD Accessing mode. |
| Mode0~4 | Manually set the IDE Accessing mode. |

- IDE Primary Slave PIO (for onboard IDE 1st channel).

The default value is Auto.

| | |
|---------|--|
| Auto | BIOS will automatically detect the IDE HDD Accessing mode. |
| Mode0~4 | Manually set the IDE Accessing mode. |

- IDE Secondary Master PIO (for onboard IDE 2nd channel).

The default value is Auto.

| | |
|---------|--|
| Auto | BIOS will automatically detect the IDE HDD Accessing mode. |
| Mode0~4 | Manually set the IDE Accessing mode. |

- IDE Secondary Slave PIO (for onboard IDE 2nd channel).

The default value is Auto.

| | |
|---------|--|
| Auto | BIOS will automatically detect the IDE HDD Accessing mode. |
| Mode0~4 | Manually set the IDE Accessing mode. |

- IDE Primary Master UDMA.

The default value is Auto.

| | |
|----------|--|
| Auto | BIOS will automatically detect the IDE HDD Accessing mode. |
| Disabled | Disable UDMA function. |

- IDE Primary Slave UDMA.

The default value is Auto.

| | |
|----------|--|
| Auto | BIOS will automatically detect the IDE HDD Accessing mode. |
| Disabled | Disable UDMA function. |

- IDE Secondary Master UDMA.

The default value is Auto.

| | |
|----------|--|
| Auto | BIOS will automatically detect the IDE HDD Accessing mode. |
| Disabled | Disable UDMA function. |

- IDE Secondary Slave UDMA.

The default value is Auto.

| | |
|----------|--|
| Auto | BIOS will automatically detect the IDE HDD Accessing mode. |
| Disabled | Disable UDMA function. |

- On-Chip Primary PCI IDE

The default value is Enabled.

| | |
|----------|---------------------------------------|
| Enabled | Enable onboard 1st channel IDE port. |
| Disabled | Disable onboard 1st channel IDE port. |

- On-Chip Secondary PCI IDE

The default value is Enabled.

| | |
|----------|---------------------------------------|
| Enabled | Enable onboard 2nd channel IDE port. |
| Disabled | Disable onboard 2nd channel IDE port. |

- Onboard PCI SCSI chip

The default value is Enabled.

| | |
|----------|--------------------------------|
| Enabled | Enable onboard PCI SCSI chip. |
| Disabled | Disable onboard PCI SCSI chip. |

- SCSI Terminator Enable

The default value is Both.

| | |
|-----------|------------------------------|
| Both | Support All SCSI Device. |
| None | Disable SCSI Device Support. |
| Low Byte | Low Byte-OFF. |
| High Byte | High Byte-ON. |

- USB Keyboard Support

The default value is Disabled.

| | |
|----------|-------------------------------|
| Enabled | Enable USB Keyboard Support. |
| Disabled | Disable USB Keyboard Support. |

- Onboard FDC Controller

The default value is Enabled.

| | |
|----------|---------------------------|
| Enabled | Enable onboard FDD port. |
| Disabled | Disable onboard FDD port. |

- Onboard Serial Port 1

The default value is 3F8/IRQ4.

| | |
|----------|---|
| Auto | BIOS will automatically setup the port 1 address. |
| 3F8/IRQ4 | Enable onboard Serial port 1 and address is 3F8. |
| 2F8/IRQ3 | Enable onboard Serial port 1 and address is 2F8. |
| 3E8/IRQ4 | Enable onboard Serial port 1 and address is 3E8. |
| 2E8/IRQ3 | Enable onboard Serial port 1 and address is 2E8. |
| Disabled | Disable onboard Serial port 1. |

- Onboard Serial Port 2

The default value is 2F8/IRQ3.

| | |
|----------|---|
| Auto | BIOS will automatically setup the port 2 address. |
| 3F8/IRQ4 | Enable onboard Serial port 2 and address is 3F8. |
| 2F8/IRQ3 | Enable onboard Serial port 2 and address is 2F8. |
| 3E8/IRQ4 | Enable onboard Serial port 2 and address is 3E8. |
| 2E8/IRQ3 | Enable onboard Serial port 2 and address is 2E8. |
| Disabled | Disable onboard Serial port 2. |

- Onboard Parallel port

The default value is 378/IRQ7.

| | |
|----------|--|
| 378/IRQ7 | Enable onboard LPT port and address is 378/IRQ7. |
| 278/IRQ5 | Enable onboard LPT port and address is 278/IRQ5. |
| Disabled | Disable onboard LPT port. |
| 3BC/IRQ7 | Enable onboard LPT port and address is 3BC/IRQ7. |

- Parallel Port Mode

The default value is SPP.

| | |
|---------|--|
| SPP | Using Parallel port as Standard Printer Port. |
| EPP | Using Parallel port as Enhanced Parallel Port. |
| ECP | Using Parallel port as Extended Capabilities Port. |
| ECP/EPP | Using Parallel port as ECP & EPP mode. |

- PS/2 Mouse Power on

The default value is Disabled.

| | |
|--------------|---|
| Disabled | Disable PS/2 Mouse Power on . |
| Left Double | Click twice on PS/2 mouse left button to Power on system. |
| Right Double | Click twice on PS/2 mouse right button to Power on |

4.12. USER PASSWORD

When you select this function, the following message will appear at the center of the screen to assist you in creating a password.

ROM PCI / ISA BIOS
 USER PASSWORD
 AWARD SOFTWARE, INC.

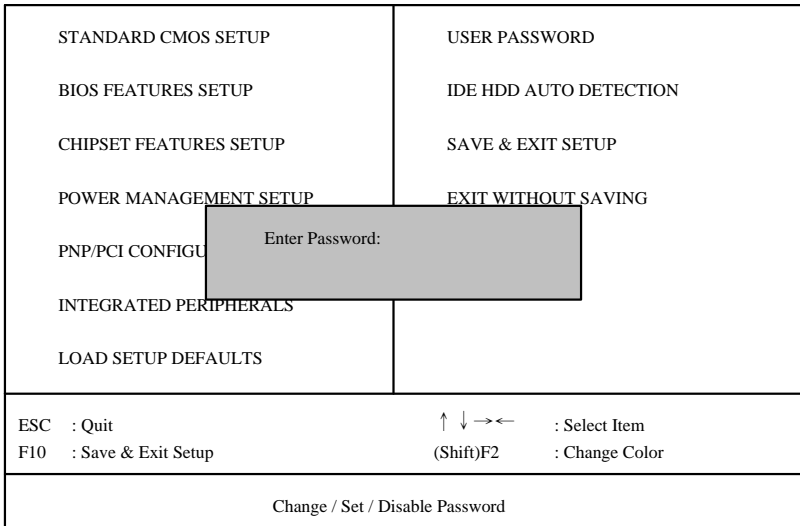

Figure 4.8: Password Setting

Type the password, up to eight characters, and press <Enter>. The password typed now will clear the previously entered password from CMOS memory. You will be asked to confirm the password. Type the password again and press <Enter>. You may also press <Esc> to abort the selection and not enter a password.

To disable password, just press <Enter> when you are prompted to enter password. A message "PASSWORD DISABLED" will appear to confirm the password being disabled. Once the password is disabled, the system will boot and you can enter Setup freely.

If you select System at Security Option in BIOS Features Setup Menu, you will be prompted for the password every time the system is rebooted or any time you try to enter Setup Menu. If you select Setup at Security Option in

BIOS Features Setup Menu, you will be prompted only when you try to enter Setup.

4.13. IDE HDD AUTO DETECTION

ROM PCI / ISA BIOS
 IDE HDD AUTO DETECTION
 AWARD SOFTWARE, INC.

| HARD DISKS | TYPE | SIZE | CYLS. | HEAD | PRECOMP | LANDZ | SECTOR | MODE |
|--|------|-------|-------|---------|---------|--------|--------|------|
| Primary Master : | | | | | | | | |
| Select Primary Master Option (N=Skip): N | | | | | | | | |
| OPTION | SIZE | CYLS. | HEAD | PRECOMP | LANDZ | SECTOR | MODE | |
| 1 (Y) | 521 | 530 | 32 | 0 | 1059 | 63 | LBA | |
| 2 | 521 | 1060 | 16 | 65535 | 1059 | 63 | NORMAL | |
| 3 | 521 | 530 | 32 | 65535 | 1059 | 63 | LARGE | |
| ESC : Skip | | | | | | | | |

Figure 4.9: IDE HDD Auto Detection

Type "Y" will accept the H.D.D. parameter reported by BIOS.

Type "N" will keep the old H.D.D. parameter setup. If the hard disk cylinder number is over 1024, then the user can select LBA mode or LARGER mode for DOS partition larger than 528 MB.

| |
|--|
| <p align="center">DECLARATION OF CONFORMITY Per FCC Part 2 Section 2.1077(a)</p> <p align="center">FC</p> <p>Responsible Party Name: G.B.T. INC.</p> <p>Address: 18365 Valley Blvd., Suite#A LA Puente, CA 91744</p> <p>Phone/Fax No: (818) 854-9338 / (818) 854-9339</p> <p>herby declares that the product</p> <p>Product Name: Mother Board</p> <p>Model Number: GA66SLX</p> <p>Conforms to the following specifications:</p> <p>FCC Part 15, Subpart B, Section 15.107(a) and Section 15.109(a), Class B Digital Device.</p> <p>Supplementary Information:</p> <p>This device complies with part 15 of the FCC Rules. Operation is subject to the following two conditions: (1) This device may not cause harmful interference, and (2) this device must accept any interference received, including interference that may cause undesired operation.</p> <p>Representative Person's Name: <u>ERIC LIU</u></p> <p>Signature: <u>Eric Liu</u></p> <p>Date: <u>Aug. 18, 1997</u></p> |
|--|

FCC Compliance Statement:

This equipment has been tested and found to comply with limits for a Class B digital device , pursuant to Part 15 of the FCC rules. These limits are designed to provide reasonable protection against harmful interference in residential installations. This equipment generates, uses, and can radiate radio frequency energy, and if not installed and used in accordance with the instructions, may cause harmful interference to radio communications. However, there is no guarantee that interference will not occur in a particular installation. If this equipment does cause

interference to radio or television equipment reception, which can be determined by turning the equipment off and on, the user is encouraged to try to correct the interference by one or more of the following measures:

- Reorient or relocate the receiving antenna
- Move the equipment away from the receiver
- Plug the equipment into an outlet on a circuit different from that to which the receiver is connected
- Consult the dealer or an experienced radio/television technician for additional suggestions

You are cautioned that any change or modifications to the equipment not expressly approve by the party responsible for compliance could void Your authority to operate such equipment.

This device complies with Part 15 of the FCC Rules. Operation is subjected to the following two conditions 1) this device may not cause harmful interference and 2) this device must accept any interference received, including interference that may cause undesired operation.

Declaration of Conformity

We, Manufacturer/Importer
(full address)

G.B.T. Technology Trading GmbH
Ausschlagler Weg 41, 1F, 20537 Hamburg, Germany

declare that the product
(description of the apparatus, system, installation to which it refers)

Mother Board
GA-686SLX

is in conformity with
(reference to the specification under which conformity is declared)
in accordance with 89/336 EEC-EMC Directive

- | | | | |
|---|--|--|--|
| <input type="checkbox"/> EN 55011 | Limits and methods of measurement of radio disturbance characteristics of industrial, scientific and medical (ISM) high frequency equipment | <input type="checkbox"/> EN 61000-3-2* <input checked="" type="checkbox"/> EN60555-2 | Disturbances in supply systems caused by household appliances and similar electrical equipment "Harmonics" |
| <input type="checkbox"/> EN55013 | Limits and methods of measurement of radio disturbance characteristics of broadcast receivers and associated equipment | <input type="checkbox"/> EN61000-3-3* <input checked="" type="checkbox"/> EN60555-3 | Disturbances in supply systems caused by household appliances and similar electrical equipment "Voltage fluctuations" |
| <input type="checkbox"/> EN 55014 | Limits and methods of measurement of radio disturbance characteristics of household electrical appliances, portable tools and similar electrical apparatus | <input checked="" type="checkbox"/> EN 50081-1 <input checked="" type="checkbox"/> EN 50082-1 | Generic emission standard Part 1: Residual, commercial and light industry Generic immunity standard Part 1: Residual, commercial and light industry |
| <input type="checkbox"/> EN 55015 | Limits and methods of measurement of radio disturbance characteristics of fluorescent lamps and luminaires | <input type="checkbox"/> EN 55081-2 | Generic emission standard Part 2: Industrial environment |
| <input type="checkbox"/> EN 55020 | Immunity from radio interference of broadcast receivers and associated equipment | <input type="checkbox"/> EN 55082-2 | Generic immunity standard Part 2: Industrial environment |
| <input checked="" type="checkbox"/> EN 55022 | Limits and methods of measurement of radio disturbance characteristics of information technology equipment | <input type="checkbox"/> ENV 55104 | Immunity requirements for household appliances tools and similar apparatus |
| <input type="checkbox"/> DIN VDE 0855 <input type="checkbox"/> part 10 <input type="checkbox"/> part 12 | Cabled distribution systems; Equipment for receiving and/or distribution from sound and television signals | <input type="checkbox"/> EN 50091- 2 | EMC requirements for uninterruptible power systems (UPS) |

CE marking



(EC conformity marking)

The manufacturer also declares the conformity of above mentioned product with the actual required safety standards in accordance with LVD 73/23 EEC

- | | | | |
|-----------------------------------|---|-------------------------------------|---|
| <input type="checkbox"/> EN 60065 | Safety requirements for mains operated electronic and related apparatus for household and similar general use | <input type="checkbox"/> EN 60950 | Safety for information technology equipment including electrical business equipment |
| <input type="checkbox"/> EN 60335 | Safety of household and similar electrical appliances | <input type="checkbox"/> EN 50091-1 | General and Safety requirements for uninterruptible power systems (UPS) |

Manufacturer/Importer

Signature : Rex Lin

(Stamp)

Date : Oct. 25, 1997

Name : Rex Lin