

5SG100

USER'S MANUAL

- * Support Intel Pentium, MMX/Cyrix/IBM 6x86MX/MII & AMD K5, K6, K6-2 & IDT C6 CPUs.
- * Support auto detect CPU Voltage.
- * Support auto detect four positive Voltages and Fan Speed.
- * Support Parity check or Ecc Function.
- * Support Ultra DMA/33 Function.
- * Support Fully AGP 1.0 Specification.
- * Support switching mode Voltage regulator on Board.
- * Support 60/66/75/83/95MHz and 100MHz (optional).
- * Support Wake on Lan. (The ATX power supply supports larger than 600 mA).
- * Support K/B Power-on , modem Ring-on , Win95 Power off , RTC Alarm.
- * Support 3 steps ACPI LED.
- * Thermal Protection : 1.When the system is overheating, it will stop for a few secs. 2.Then back to normal status after the system's temp. step down . 3. Users better check CPU fan immediately.

Pentium[®] Processor PCI - ISA BUS MAINBOARD
REV. 2.0 Second Edition
R-20-02-080805

The author assumes no responsibility for any errors or omissions which may appear in this document nor does it make a commitment to update the information contained herein.

*THIRD-PARTY BRANDS AND NAMES ARE THE PROPERTY OF THEIR RESPECTIVE OWNERS.

Aug 5, 1998 Taipei, Taiwan

I. Quick Installation Guide:

SWITCH	SW1								SW2				
	CPU	1	2	3	4	5	6	7	8	1	2	3	4
1. Pentium [®] Processor 90 MHz	OFF	OFF	OFF	OFF	OFF	OFF	OFF	ON	OFF	OFF	OFF	OFF	OFF
2. Pentium [®] Processor 100 MHz	OFF	OFF	OFF	OFF	OFF	OFF	OFF	ON	OFF	ON	OFF	OFF	OFF
3. Pentium [®] Processor 120 MHz	OFF	ON	OFF	OFF	OFF	OFF	ON	OFF	OFF	OFF	OFF	OFF	OFF
4. Pentium [®] Processor 133 MHz	OFF	ON	OFF	OFF	OFF	OFF	ON	OFF	ON	OFF	OFF	OFF	OFF
5. Pentium [®] Processor 150 MHz	OFF	ON	ON	OFF	OFF	OFF	ON	OFF	OFF	OFF	OFF	OFF	OFF
6. Pentium [®] Processor 166 MHz	OFF	ON	ON	OFF	OFF	OFF	ON	OFF	ON	OFF	OFF	OFF	OFF
7. Pentium [®] Processor 180 MHz	OFF	OFF	ON	OFF	OFF	OFF	ON	OFF	OFF	OFF	OFF	OFF	OFF
8. Pentium [®] Processor 200 MHz	OFF	OFF	ON	OFF	OFF	OFF	ON	OFF	ON	OFF	OFF	OFF	OFF
9. Intel MMX-150MHz	OFF	ON	ON	OFF	OFF	OFF	ON	OFF	OFF	OFF	OFF	OFF	OFF
10. Intel MMX-166MHz	OFF	ON	ON	OFF	OFF	OFF	ON	OFF	ON	OFF	OFF	OFF	OFF
11. Intel MMX-200MHz	OFF	OFF	ON	OFF	OFF	OFF	ON	OFF	ON	OFF	OFF	OFF	OFF
12. Intel MMX-233MHz	OFF	OFF	OFF	OFF	OFF	OFF	ON	OFF	ON	OFF	OFF	OFF	OFF
13. P54CT-150 MHz	OFF	ON	ON	OFF	OFF	OFF	ON	OFF	OFF	OFF	OFF	OFF	OFF
14. P54CT-166 MHz	OFF	ON	ON	OFF	OFF	OFF	ON	OFF	ON	OFF	OFF	OFF	OFF
15. P54CTB-150 MHz	OFF	ON	ON	OFF	OFF	OFF	ON	OFF	OFF	OFF	OFF	OFF	OFF
16. P54CTB-166 MHz	OFF	ON	ON	OFF	OFF	OFF	ON	OFF	ON	OFF	OFF	OFF	OFF
17. P54CTB-200 MHz	OFF	OFF	ON	OFF	OFF	OFF	ON	OFF	ON	OFF	OFF	OFF	OFF
18. AMDK5-PR133	OFF	ON	OFF	OFF	OFF	OFF	ON	OFF	ON	OFF	OFF	OFF	OFF
19. AMDK5-PR166	OFF	ON	ON	OFF	OFF	OFF	ON	OFF	ON	OFF	OFF	OFF	OFF

SWITCH	SW1								SW2				
	CPU	1	2	3	4	5	6	7	8	1	2	3	4
20. AMD-K6/166 (2.9V)	OFF	ON	ON	OFF	OFF	ON	ON	OFF	ON	OFF	OFF	OFF	OFF
21. AMD-K6/180 (2.9V)	OFF	OFF	ON	OFF	OFF	ON	ON	OFF	OFF	OFF	OFF	OFF	OFF
22. AMD-K6/200 (2.9V)	OFF	OFF	ON	OFF	OFF	ON	ON	OFF	ON	OFF	OFF	OFF	OFF
23. AMD-K6/233 (3.2V)	OFF	OFF	OFF	ON	OFF	OFF	ON	OFF	ON	OFF	OFF	OFF	OFF
24. AMD-K6/266 (66*4 2.2V)	OFF	ON	OFF	OFF	ON	OFF	OFF	ON	ON	OFF	OFF	OFF	OFF
25. AMD-K6/300 (66*4.5 2.2V)	OFF	ON	ON	OFF	ON	OFF	OFF	ON	ON	OFF	OFF	OFF	OFF
26. Cyrix/IBM 6x86-120MHz- PR150+	OFF	ON	OFF	OFF	OFF	OFF	ON	OFF	OFF	OFF	OFF	OFF	OFF
27. Cyrix/IBM 6x86-133MHz- PR166+	OFF	ON	OFF	OFF	OFF	OFF	ON	OFF	ON	OFF	OFF	OFF	OFF
28. Cyrix/IBM 6x86-150MHz- PR200+	OFF	ON	OFF	OFF	OFF	OFF	ON	OFF	OFF	OFF	ON	OFF	OFF
29. Cyrix/IBM 6x86L- PR150+ (2.8V)	OFF	ON	OFF	OFF	OFF	OFF	ON	OFF	OFF	OFF	OFF	OFF	OFF
30. Cyrix/IBM 6x86L-PR166+ (2.8V)	OFF	ON	OFF	OFF	OFF	OFF	ON	OFF	ON	OFF	OFF	OFF	OFF
31. Cyrix/IBM 6x86L-PR200+ (2.8V)	OFF	ON	OFF	OFF	OFF	OFF	ON	OFF	OFF	OFF	ON	OFF	OFF
32. Cyrix/IBM 6x86MX-PR150 (60*2 2.9V)	OFF	ON	OFF	OFF	OFF	ON	ON	OFF	OFF	OFF	OFF	OFF	OFF
33. Cyrix/IBM 6x86MX-PR166 (60*2.5 2.9V)	OFF	ON	ON	OFF	OFF	ON	ON	OFF	OFF	OFF	OFF	OFF	OFF
34. Cyrix/IBM 6x86MX-PR166 (66*2 2.9V)	OFF	ON	OFF	OFF	OFF	ON	ON	OFF	ON	OFF	OFF	OFF	OFF
35. Cyrix/IBM 6x86MX-PR200 (60*3 2.9V)	OFF	OFF	ON	OFF	OFF	ON	ON	OFF	OFF	OFF	OFF	OFF	OFF
36. Cyrix/IBM 6x86MX-PR200 (66*2.5 2.9V)	OFF	ON	ON	OFF	OFF	ON	ON	OFF	ON	OFF	OFF	OFF	OFF
37. Cyrix/IBM 6x86MX-PR200 (75*2 2.9V)	OFF	ON	OFF	OFF	OFF	ON	ON	OFF	OFF	OFF	ON	OFF	OFF

38. Cyrix/IBM 6x86MX-PR233 (66*3 2.9V)	OFF	OFF	ON	OFF	OFF	ON	ON	OFF	ON	OFF	OFF	OFF
SWITCH	SW1								SW2			
CPU	1	2	3	4	5	6	7	8	1	2	3	4
39. Cyrix/IBM 6x86MX-PR233 (75*2.5 2.9V)	OFF	ON	ON	OFF	OFF	ON	ON	OFF	OFF	OFF	ON	OFF
40. Cyrix/IBM 6x86MX-PR233 (83*2 2.9V)	OFF	ON	OFF	OFF	OFF	ON	ON	OFF	ON	OFF	ON	OFF
41. Cyrix/IBM 6x86MX-PR266 (66*3.5 2.9V)	OFF	OFF	OFF	OFF	OFF	ON	ON	OFF	ON	OFF	OFF	OFF
42. Cyrix/IBM 6x86MX-PR266 (75*3 2.9V)	OFF	OFF	ON	OFF	OFF	ON	ON	OFF	OFF	OFF	ON	OFF
43. Cyrix/IBM 6x86MX-PR266 (83*2.5 2.9V)	OFF	ON	ON	OFF	OFF	ON	ON	OFF	ON	OFF	ON	OFF
44. Cyrix MII-300 (66*3.5 2.9V)	OFF	OFF	OFF	OFF	OFF	ON	ON	OFF	ON	OFF	OFF	OFF
45.IDT WinChip C6-225 (75*3 3.52V)	OFF	OFF	ON	OFF	OFF	OFF	ON	OFF	OFF	OFF	ON	OFF
46.IBM MX PR333 (100*2.5 2.9V)	OFF	ON	ON	OFF	OFF	ON	ON	OFF	ON	ON	ON	OFF
47. AMD-K6-2/250 (100*2.5 2.2V)	OFF	ON	ON	OFF	ON	OFF	OFF	OFF	ON	ON	ON	OFF
48. AMD-K6-2/266 (66*4 2.2V)	OFF	ON	OFF	OFF	ON	OFF	OFF	ON	ON	OFF	OFF	OFF
49. AMD-K6-2/300 (100*3 2.2V)	OFF	OFF	ON	OFF	ON	OFF	OFF	OFF	ON	ON	ON	OFF
50. AMD-K6-2/333 (95*3.5 2.2V)	OFF	OFF	OFF	OFF	ON	OFF	OFF	OFF	OFF	ON	ON	OFF
51. AMD-K6-2/350 (100*3.5 2.2V)	OFF	OFF	OFF	OFF	ON	OFF	OFF	OFF	ON	ON	ON	OFF

★ Note : If Cyrix 6x86 is being used, please check the CPU Date Code after 605.

★ Note : We don't recommend you to setup your system speed to 100 MHz because this frequencies is not the standard specifications for CPU, Chipset and most of the peripherals. Whether your system can run 100 MHz properly will depend on your hardware configurations : CPU, SDRAM, Cards, etc.

● **The default setting is 100*3 at 2.2V for AMD K6/300 and AMD K6-2/300**

SWITCH	SW1								SW2			
CPU	1	2	3	4	5	6	7	8	1	2	3	4

AMD-K6/300 (100*3 2.2V)	OFF	OFF	ON	OFF	ON	OFF	OFF	OFF	ON	ON	ON	OFF
AMD-K6-2/300 (100*3 2.2V)				F								

1. Pentium[®] Processor 90 MHz

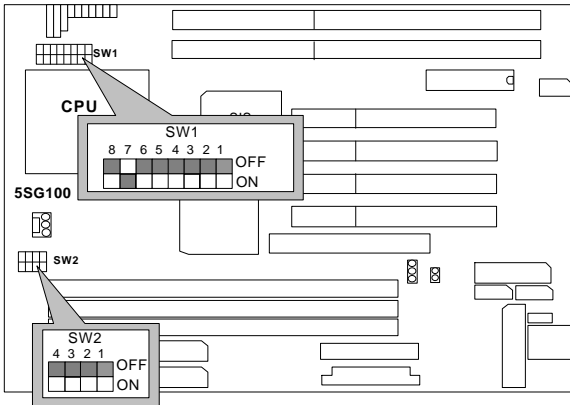

2. Pentium[®] Processor 100 MHz

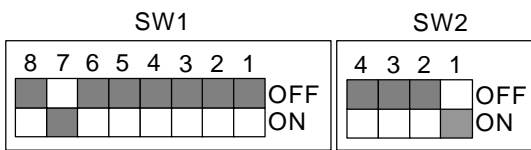

3. Pentium[®] Processor 120 MHz

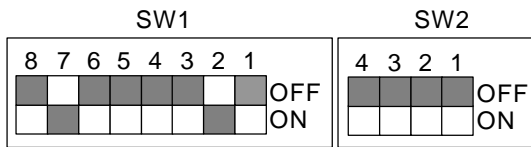

4. Pentium[®] Processor 133 MHz

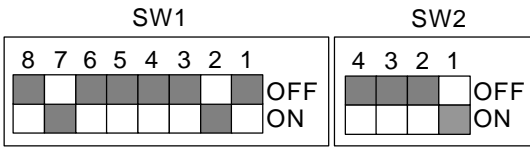

5. Pentium[®] Processor 150 MHz

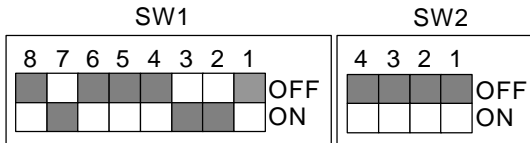

6. Pentium[®] Processor 166 MHz

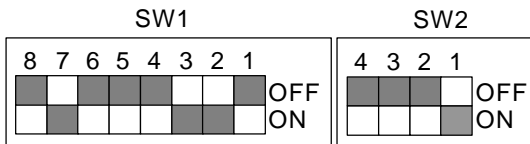

7. Pentium[®] Processor 180 MHz

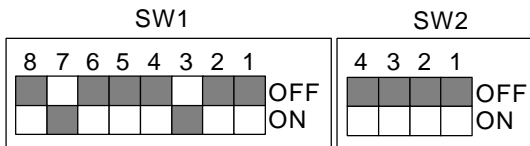

8. Pentium[®] Processor 200 MHz

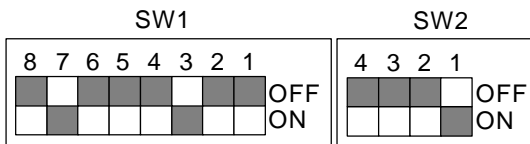

9. Intel MMX-150 MHz

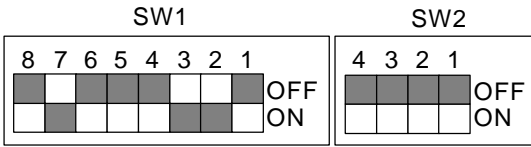

10. Intel MMX-166 MHz

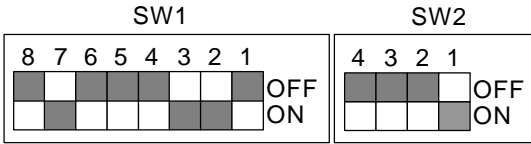

11. Intel MMX-200 MHz

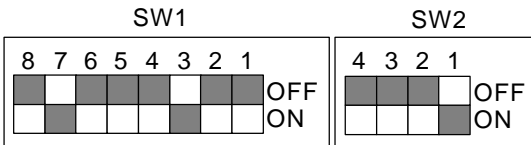

12. Intel MMX-233 MHz

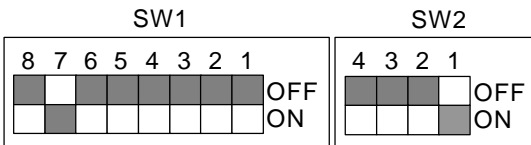

13. P54CT-150 MHz

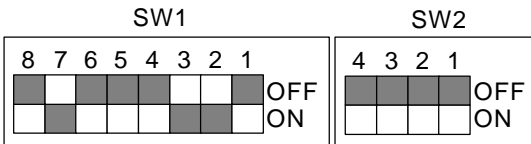

14. P54CT-166 MHz

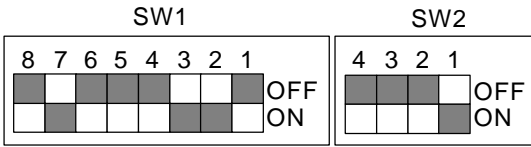

15. P54CTB-150 MHz

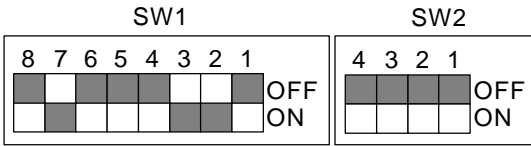

16. P54CTB-166 MHz

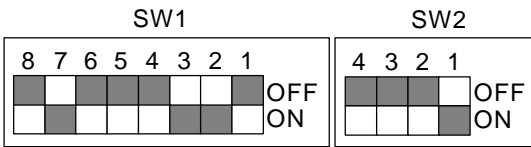

17. P54CTB-200 MHz

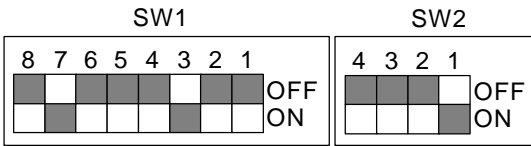

18. AMDK5-PR133

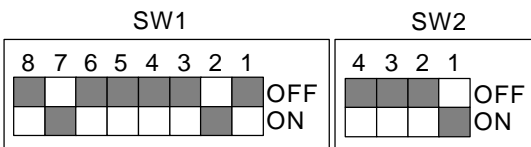

19. AMDK5-PR166

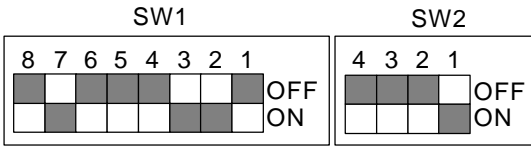

20. AMD-K6/166 (2.9V)

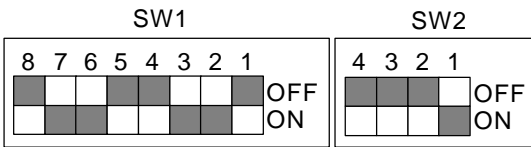

21. AMD-K6/180 (2.9V)

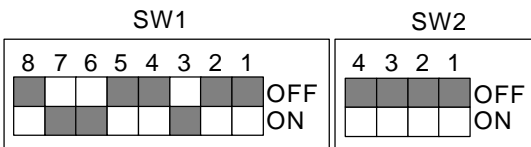

22. AMD-K6/200 (2.9V)

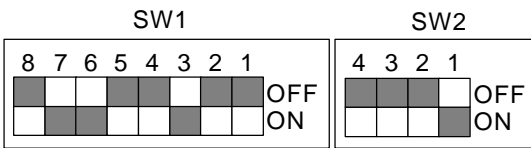

23. AMD-K6/233 (3.2V)

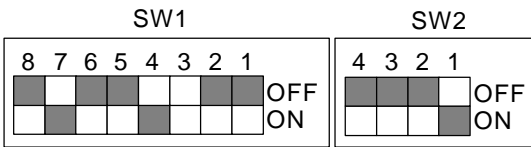

24. AMD-K6 /266 (66*4 2.2V)

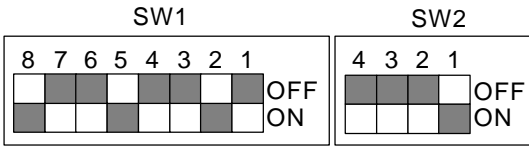

25. AMD-K6 /300 (66*4.5 2.2V)

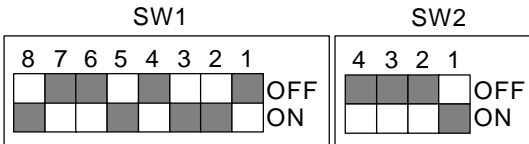

26. Cyrix / IBM 6x86-120 MHz-PR150+

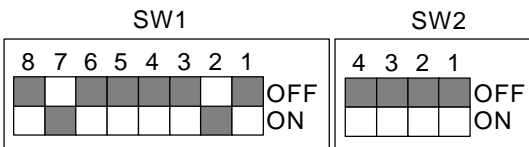

27. Cyrix / IBM 6x86-133 MHz-PR166+

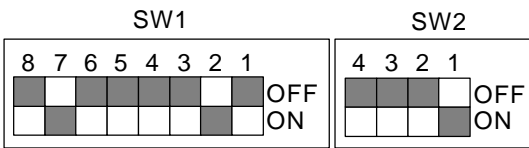

28. Cyrix / IBM 6x86-150 MHz-PR200+

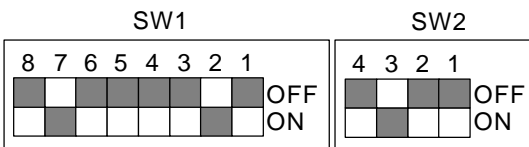

29. Cyrix / IBM 6x86L-PR150+ (2.8V)

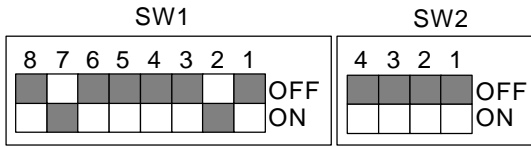

30. Cyrix / IBM 6x86L-PR166+ (2.8V)

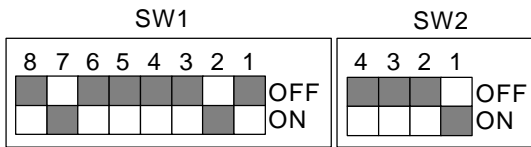

31. Cyrix / IBM 6x86L-PR200+ (2.8V)

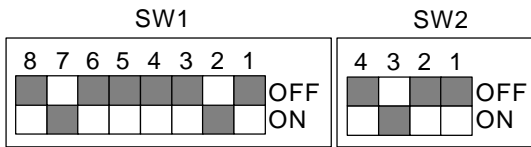

32. Cyrix / IBM 6x86MX-PR150 (60x2 2.9V)

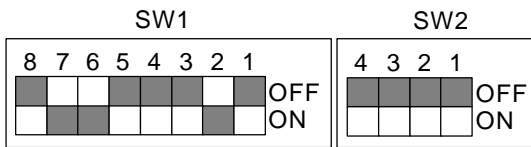

33. Cyrix / IBM 6x86MX-PR166 (60x2.5 2.9V)

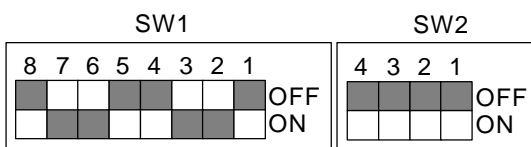

34. Cyrix / IBM 6x86MX-PR166 (66x2 2.9V)

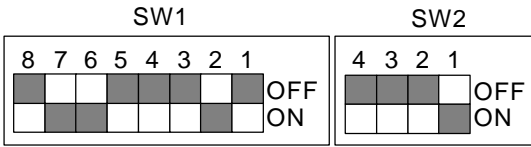

35. Cyrix / IBM 6x86MX-PR200 (60x3 2.9V)

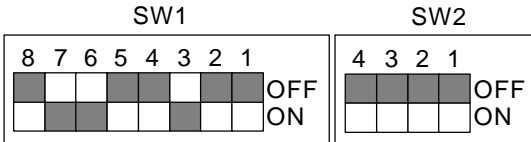

36. Cyrix / IBM 6x86MX-PR200 (66x2.5 2.9V)

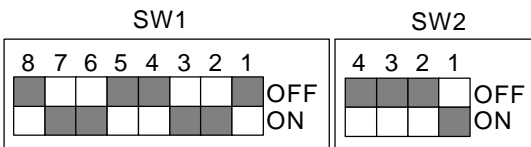

37. Cyrix / IBM 6x86MX-PR200 (75x2 2.9V)

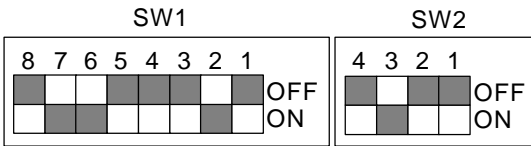

38. Cyrix / IBM 6x86MX-PR233 (66x3 2.9V)

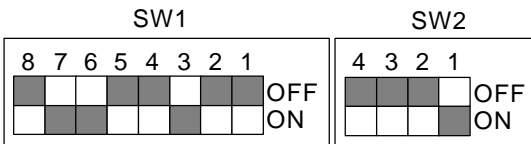

39. Cyrix / IBM 6x86MX-PR233 (75x2.5 2.9V)

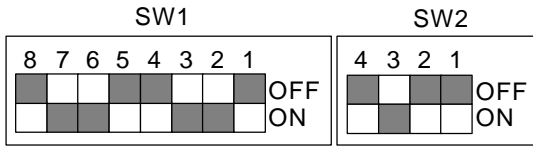

40. Cyrix / IBM 6x86MX-PR233 (83x2 2.9V)

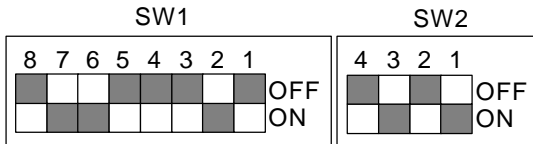

41. Cyrix / IBM 6x86MX-PR266 (66x3.5 2.9V)

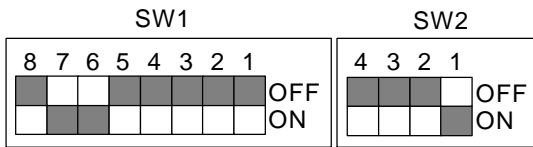

42. Cyrix / IBM 6x86MX-PR266 (75x3 2.9V)

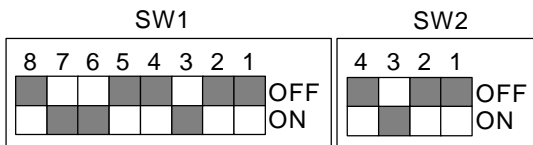

43. Cyrix / IBM 6x86MX-PR266 (83x2.5 2.9V)

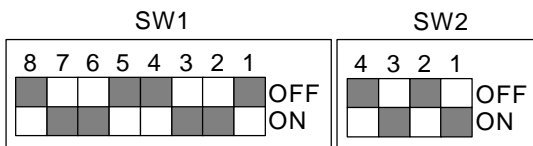

44. Cyrix MII-300 (66x3.5 2.9V)

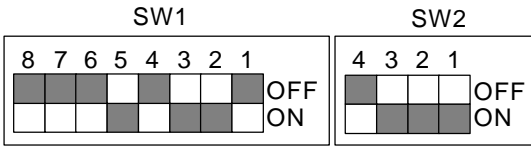

50. AMD-K6-2/333 (95*3.5 2.2V)

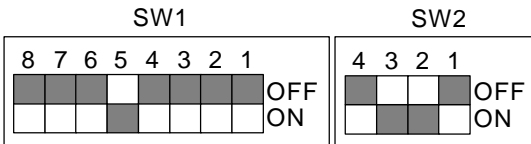

51. AMD-K6-2/350 (100*3.5 2.2V)

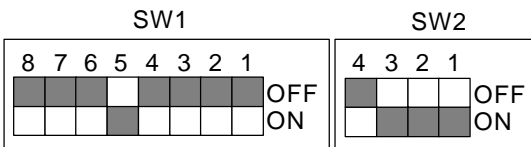

II. Quick Installation Guide of Jumper setting:

IR : Infrared Connector (Optional)

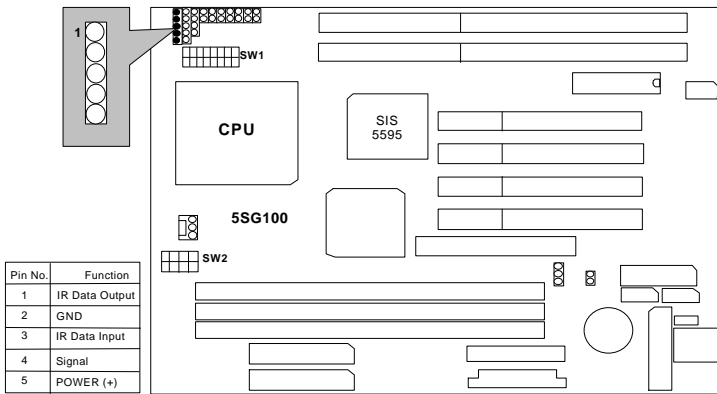

PWR : ACPI LED / Key-Lock Connector

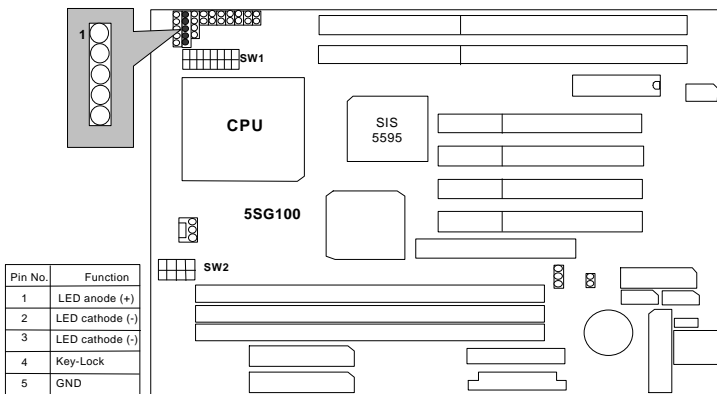

SPK : Speaker Connector

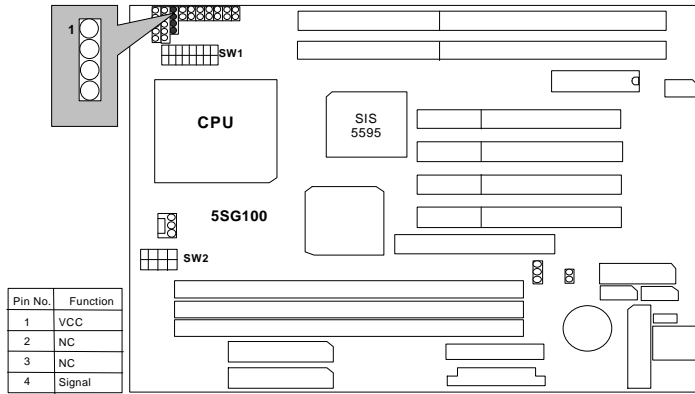

TD : Turbo LED Connector

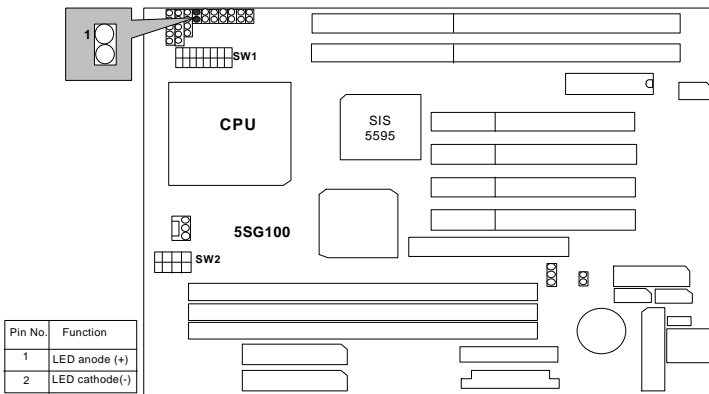

TB : Turbo Switch Connector

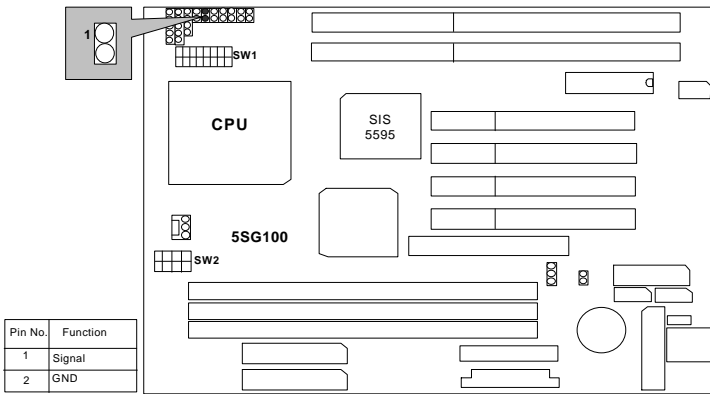

RST : Reset Switch

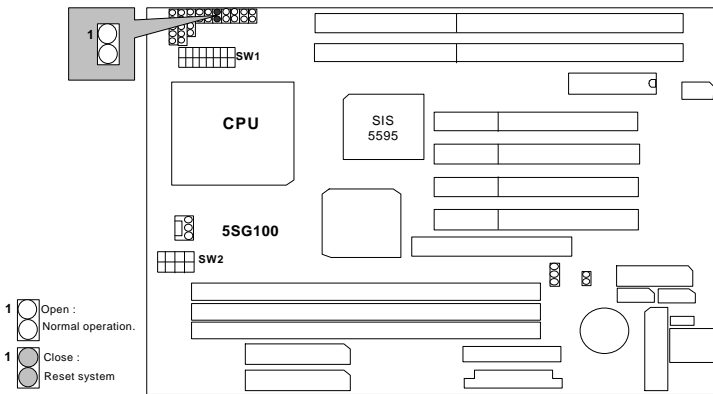

GD : Green LED Connector

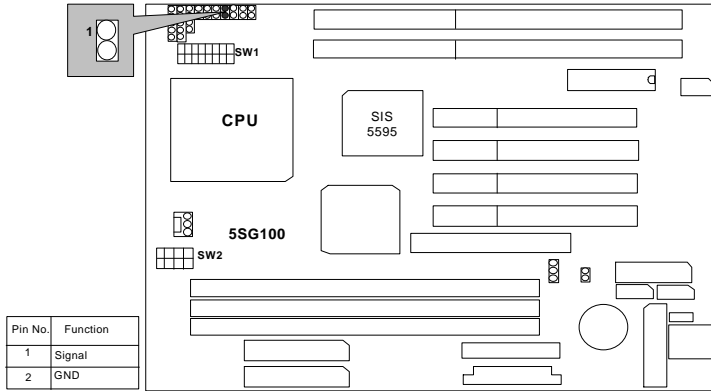

GN : Green Function Switch

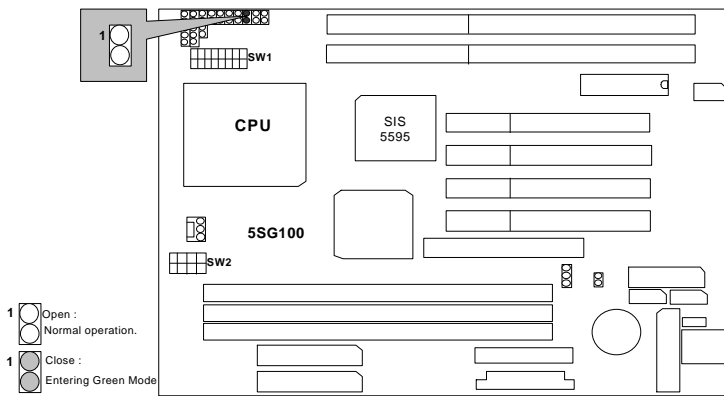

HD : IDE Hard Disk Active LED

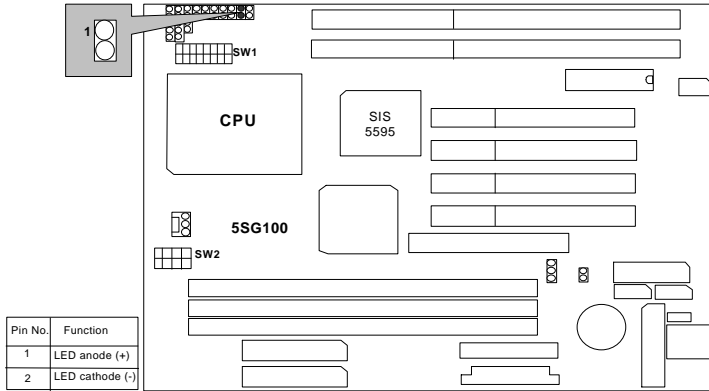

SOFT PWR : POWER ON/OFF

(For ATX Power Supply Use Only)

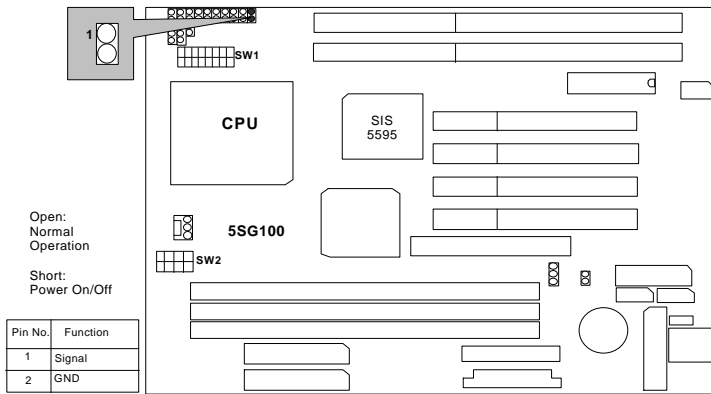

FAN PWR: CPU Cooling Fan Power Connector

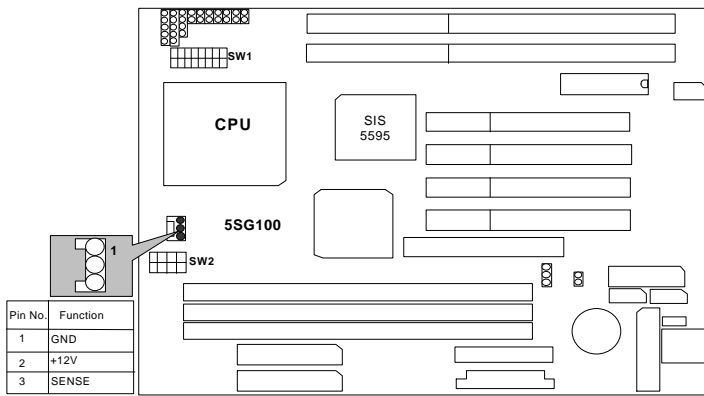

USB :USB Port

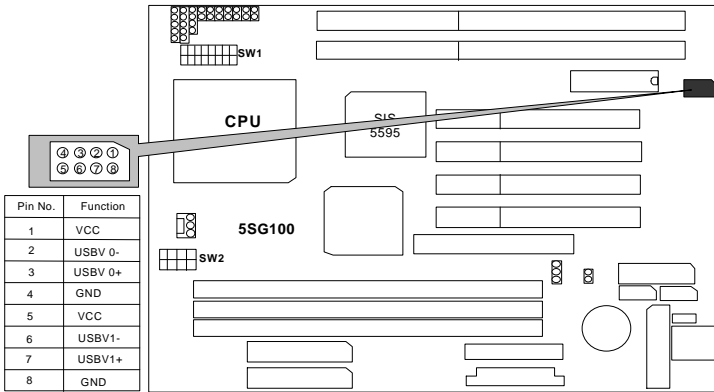

K.B : AT Keyboard

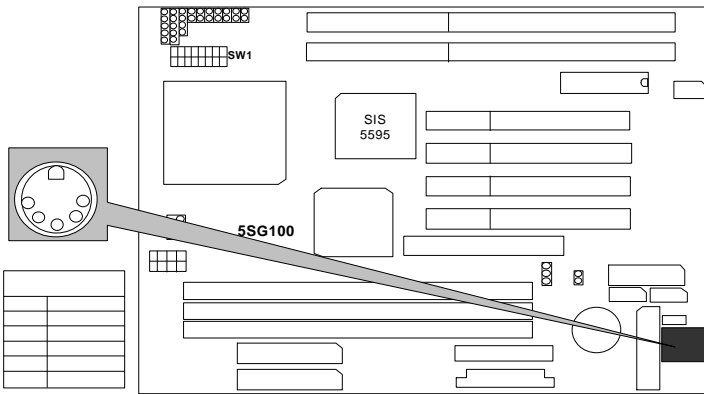

PS/2 : PS/2 Mouse

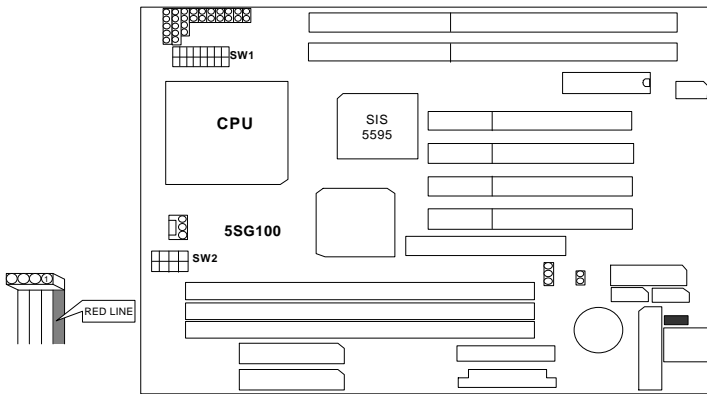

COM A : COM A PORT

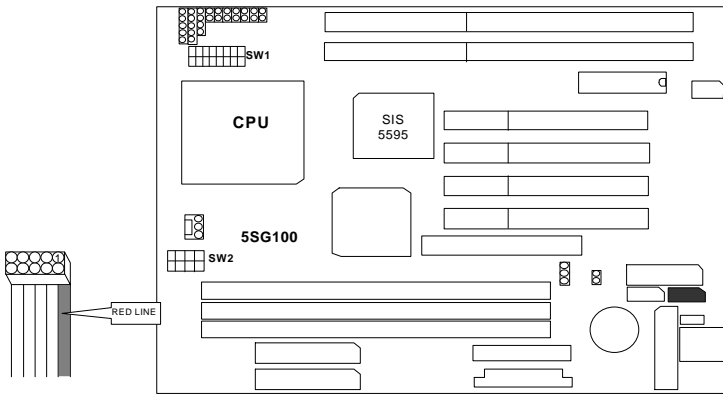

COM B : COM B PORT

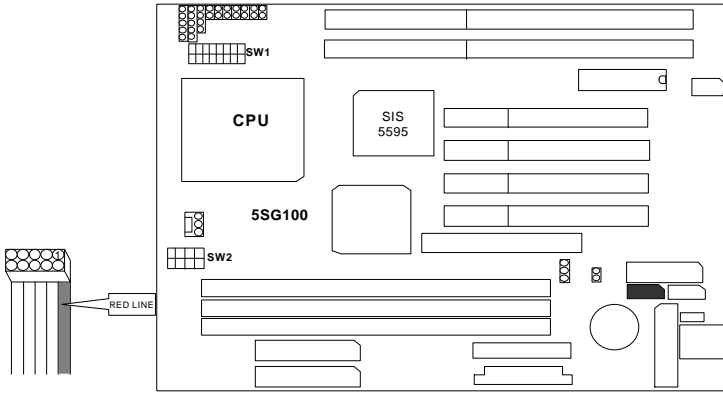

LPT : LPT PORT

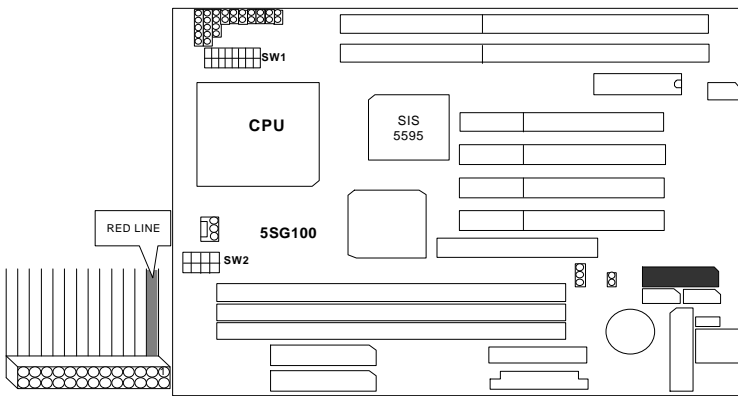

J1 : AT Power Connector

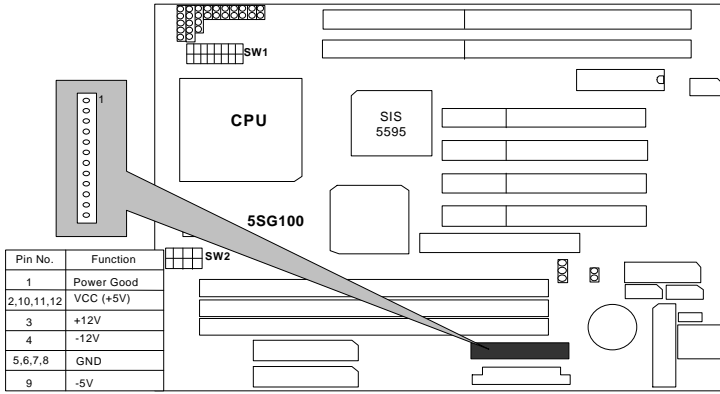

U1 : ATX Power Connector

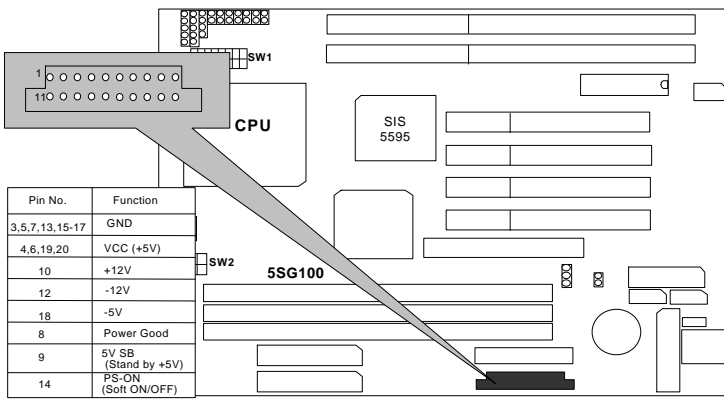

FLOPPY : FLOPPY PORT

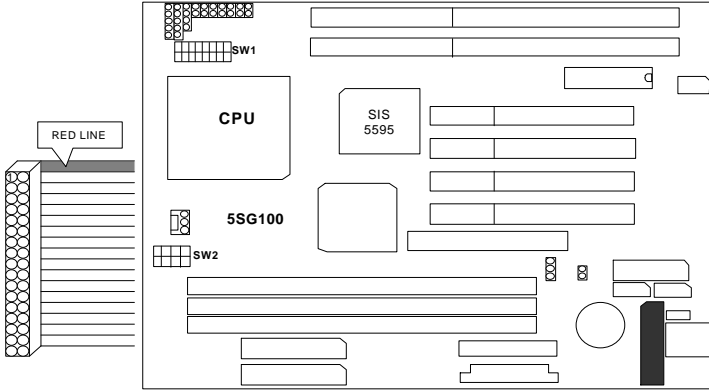

IDE1 : For Primary IDE port

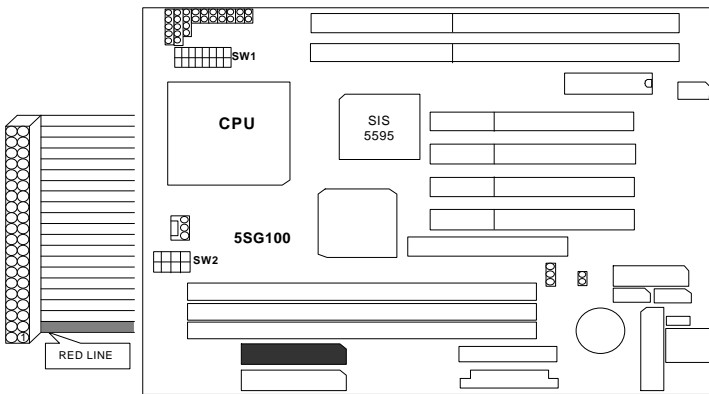

IDE2 : For Secondary IDE port

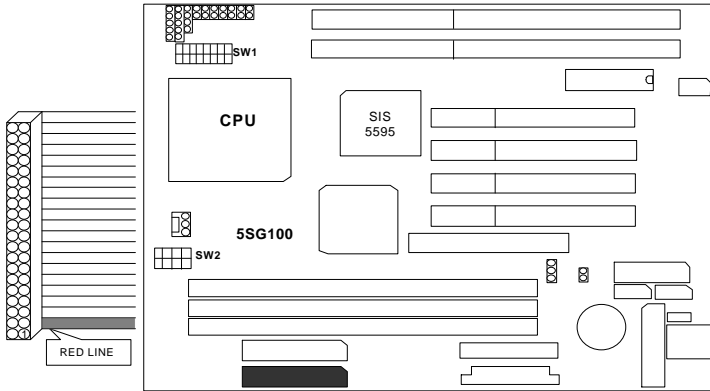

JP15 : Wake on Lan

(for ATX Power Supply only)

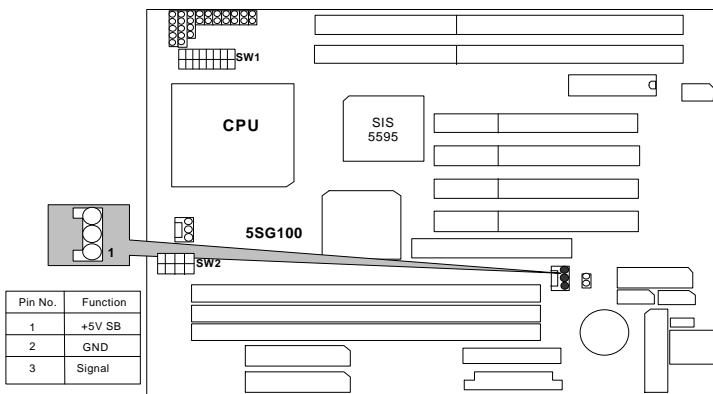

JP2 : Keyboard Power-on

(for ATX Power Supply only)

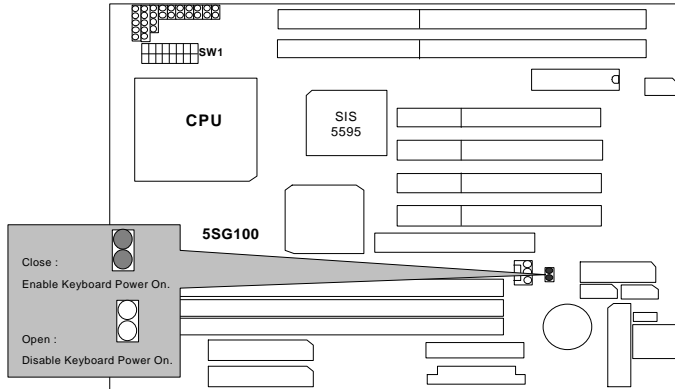

BAT 1: For Battery

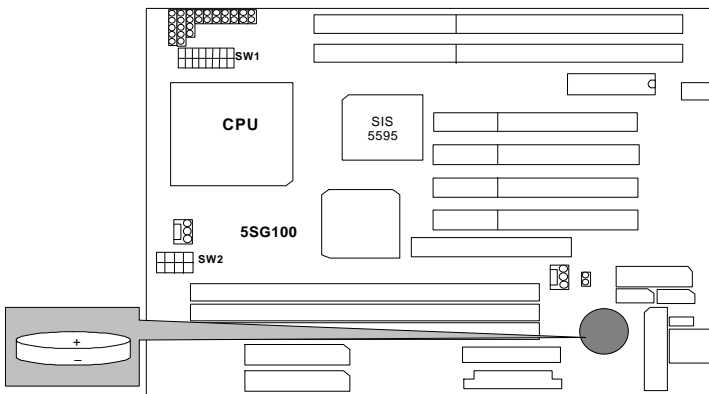

- ⚠ Danger of explosion if battery is incorrectly replaced.
- ⚠ Replace only with the same or equivalent type recommended by the manufacturer.
- ⚠ Dispose of used batteries according to the manufacturer's instructions.

 SW : For CPU INT./EXT.FREQ.

O	:ON
X	:OFF

SW1

SW1	2	3	8
X 1.5	X	X	X
X 2	O	X	X
X 2.5	O	O	X
X 3	X	O	X
X 3.5	X	X	X
X 4	O	X	O
X 4.5	O	O	O
X 5	X	O	O
X 5.5	X	X	O

SW1	4	5	6	7
AUTO	X	X	X	O
2.1V	X	X	O	X
2.2V	X	O	X	X
2.3V	X	O	O	X
2.4V	O	X	X	X
2.5V	O	X	O	X
2.6V	O	O	X	X
2.7V	O	O	O	X
2.8V	X	X	X	O
2.9V	X	X	O	O
3.0V	X	O	X	O
3.1V	X	O	O	O
3.2V	O	X	X	O
3.3V	O	X	O	O
3.4V	O	O	X	O
3.5V	O	O	O	O

SW2

CPU	PCI	AGP	1	2	3
60MHz	30	60	X	X	X
66MHz	33	66	O	X	X
68MHz	34	68	X	O	X
75MHz	37.5	75	O	O	X
75MHz	30	60	X	X	O
83MHz	33	66	O	X	O
95MHz	32	64	X	O	O
100MHz	33	66	O	O	O

III. Top Performance Test Setting:

Users have to modify the value for each item in chipset features as follow:

Chipset features setup

```

ROM PCI/ISA BIOS (2951K60A)
CHIPSET FEATURES SETUP
AWARD SOFTWARE, INC.

RAS Pulse Width Refresh : 4T
RAS Precharge Time      : 3T
RAS to CAS Delay        : 3T
CPU to PCI Post Write   : 3T
ISA Bus Clock Frequency : PCICLK/3
NA# Enable              : Enabled
SDRAM CAS Latency       : 2T
SDRAM WR Retire Rate    : X-1-1-1
SDRAM Wait State Control : 1WS
RAMW# Assertion Timing : 2T
CAS Precharge Time (EDO) : 2T
CAS# Pulse Width for EDO : 2T
CAS Precharge Time (FP) : 2T
CAS# Pulse Width for FP : 2T
Enhanced Memory Write   : Enabled
Read Prefetch Memory RD : Enabled
CPU to PCI Burst Mem. WR : Enabled
MA Current Rating       : 8mA
AGP Aperture Size       : 64MB

System BIOS Cacheable  : Enabled
Video BIOS Cacheable  : Enabled
Memory Hole at 15M-16M : Disabled
Temperature Control    : Auto
Auto Detect DIMM/PCI Clk : Enabled
Spread Spectrum        : Disabled
Current CPUFAN Speed   : 0 RPM
Current CPU UCore      : 2.84 V
Current +3.3 V         : 3.61 V
Current +5 V           : 5.21 V
Current +12 V          : 12.41 V

ESC : Quit          ↑↓↓↑ : Select Item
F1  : Help         PU/PD/+/- : Modify
F5  : Old Values  (Shift)F2 : Color
F6  : Load BIOS  Defaults
F7  : Load Setup  Defaults

```

** Each value of items as above depends on your hardware configuration : CPU , SDRAM , Cards , etc.

Please modify each value of items If your system does not work properly .

