

GA - 586DX

USER'S MANUAL

Dual PENTIUM® PCI - ISA BUS MAINBOARD

REV. 1 Third Edition

The author assumes no responsibility for any errors or omissions which may appear in this document nor does it make a commitment to update the information contained herein.

IBM PC/AT, PC/XT are trademarks of International Business Machine Corporation.
PENTIUM is a trademark of Intel Corporation.
AWARD is a trademark of Award Software, Inc.
MS-DOS WINDOWS NT are registered trademarks of Microsoft Corporation.
UNIX is a trademark of Bell Laboratories.

OCTOBER 01, 1996 Taipei, Taiwan
TABLE OF CONTENTS

1. INTRODUCTION.....	1-1
1.1. PREFACE	1-1
1.2. KEY FEATURES	1-1
1.3. PERFORMANCE LIST.....	1-2
1.4. BLOCK DIAGRAM.....	1-3
1.5. INTRODUCE THE PCI - BUS.....	1-4
1.6. FEATURES	1-4
2. SPECIFICATION.....	2-1
2.1. HARDWARE	2-1
2.2. SOFTWARE	2-2
2.3. ENVIRONMENT	2-2
3. HARDWARE INSTALLATION.....	3-1
3.1. UNPACKING	3-1
3.2. MAINBOARD LAYOUT	3-2
3.3. QUICK REFERENCE FOR JUMPERS & CONNECTORS.....	3-2
3.4. DRAM INSTALLATION	3-4
3.5. CPU INSTALLATION AND JUMPERS SETUP	3-5
3.5.1 Uni-Processor Installation	3-5
3.5.2 Dual-Processor Installation	3-5
3.6. CMOS RTC & ISA CFG CMOS SRAM	3-6
3.7. SPEAKER CONNECTOR INSTALLATION	3-6
3.8. POWER LED & KEY LOCK CONNECTOR INSTALLATION	3-7
3.9. HARDWARE RESET SWITCH CONNECTOR INSTALLATION.....	3-7
3.10. GREEN FUNCTION INSTALLATION	3-7
3.11. ATAPI DEVICE INSTALLATION.....	3-7
3.12. SCSI DEVICE INSTALLATION.....	3-7
3.13. PERIPHERAL DEVICE INSTALLATION	3-10
3.14. KEYBOARD & PS/2 MOUSE INSTALLATION	3-10
3.15. KEYBOARD SETTING FUNCTION	3-10
4. BIOS CONFIGURATION	4-1
4.1. ENTERING SETUP	4-1
4.2. CONTROL KEYS	4-2

4.3. GETTING HELP	4-3
4.3.1. Main Menu.....	4-3
4.3.2. Status Page Setup Menu / Option Page Setup Menu.....	4-3
4.4. THE MAIN MENU	4-3
4.5. STANDARD CMOS SETUP MENU	4-5
4.6. BIOS FEATURES SETUP.....	4-9
4.7. CHIPSET FEATURES SETUP	4-13
4.8. POWER MANAGEMENT SETUP.....	4-14
4.9. PNP/PCI CONFIGURATION	4-16
4.10. INTEGRATED PERIPHERALS.....	4-17
4.11. LOAD SETUP DEFAULTS	4-20
4.12. USER PASSWORD	4-21
4.13. IDE HDD AUTO DETECTION	4-22
4.14. SAVE & EXIT SETUP	4-23
4.15. EXIT WITHOUT SAVING	4-24
5. AT TECHNICAL INFORMATION	5-1
5.1. I/O BUS CONNECTOR PIN OUT	5-1
5.1.1. ISA SLOT PIN OUT	5-1
5.1.2. PCI - BUS SLOT PIN OUT	5-2
5.2. I/O & MEMORY MAP	5-3
5.3. TIMER & DMA CHANNELS MAP	5-3
5.4. INTERRUPT MAP	5-4
5.5. RTC & CMOS RAM MAP.....	5-5
APPENDIX A: POST MESSAGE	A-1
APPENDIX B: POST CODES.....	B-1
APPENDIX C: BIOS DEFAULT DRIVE TABLE	C-1
APPENDIX D: PROBLEM SHEET	D-1

1. INTRODUCTION

1.1. PREFACE

Welcome to use the **GA - 586DX** motherboard. The motherboard is a 512 KB cache Dual PENTIUM® Processor based PC / AT compatible system with ISA bus and PCI Local Bus, and has been designed to be the fastest PC / AT system. There are some new features allow you to operate the system with just the performance you want.

This manual also explains how to install the motherboard for operation, and how to set up your CMOS CONFIGURATION with BIOS SETUP program.

1.2. KEY FEATURES

- ❑ Intel Dual Pentium® Processor based PC / AT compatible mainboard.
- ❑ Supports Pentium processor,PODP running at 75-200 MHz, Cyrix 6x86, and AMD 5k86 Processor.
- ❑ 4 Master / Slave PCI Bus slots, 4 ISA Bus slots.
- ❑ Supports Dual 321 Pins (Socket 7) ZIF socket on board for Intel Processor, and Dual POWER (2.8V/3.3V) Processor.
- ❑ Supports 512 KB Pipeline Burst Sync. 2nd Cache.
- ❑ CPU L1 / L2 Write-Back cache operation.
- ❑ Supports 8 - 512 MB DRAM memory on board.
- ❑ Supports Adaptec Ultra & Wide SCSI ports for 15 SCSI Device.
- ❑ Supports Adaptec RAID Port™ on board (Ver.3X and above version).
- ❑ Supports 2 channels Enhance PCI IDE ports for 4 IDE Device.
- ❑ Supports 2xCOM (16550), 1xLPT (EPP / ECP), 1x1.44MB Floppy port.
- ❑ Supports Green function, Plug & Play function.
- ❑ Licensed AWARD BIOS, FLASH EEPROM for BIOS update.
- ❑ BENCHMARKQ3287 / DALLAS 12887 / ODIN 12C887 RTC on board.
- ❑ ATX form factor, 6 layers PCB.

1.3. PERFORMANCE LIST

The following performance data list is the testing results of some popular benchmark testing programs. These data are just referred by users, and there is no responsibility for different testing data values gotten by users. (The different Hardware & Software configuration will result in different benchmark testing results.)

- CPU Pentium® processor 200 MHz
- DRAM 32 MB EDO
- CACHE SIZE 512 KB Pipeline Burst SRAM
- DISPLAY Matrox Millennium 2MB
- STORAGE Onboard IDE port + Quantum FB 1280AT IDE Drive
Onboard SCSI port + Quantum XP 32150W SCSI Drive
- O.S. MS DOS V6.22

<DOS>

Program	Item	Unit	IDE	SCSI
LandMark Speed	CPU	MHz	1157.16	1157.16
	FPU	MHz	3355.77	3355.80
V2.0	VIDEO	chr/ms	16384	16384
Norton System Info. V8.0	CPU	Index	635.3	635.3
	Disk	Index	22.1	16.6
Core Test V.3.02	DATA Transfer Rate	KB/S	14992	17072
	Sequential Read	KB/S	6288	7168
	Random Read	KB/S	2432	2336
PC BenchMark V9.0	DOS Mark	Index	1321.61	1796.00
	CPU Mark16	Index	406.19	406.55
	Video Score	Index	6351.57	6368.49
	Disk Score	Index	673.64	1172.86

< WINDOWS > – with Display Driver at 1024 x 768 x 256 colors x 70Hz

Program	Item	Unit	IDE	SCSI
Winbench 96	CPU Mark16	index	390	397
	CPU Mark32	index	411	408
	Disk Winmark95	KB/s	1370	1340
	Graphics Winmark95	Mpixels/S	21.3	21.3
Winstone 96	Winstone96	Index	101.6	101.7

1.4. BLOCK DIAGRAM

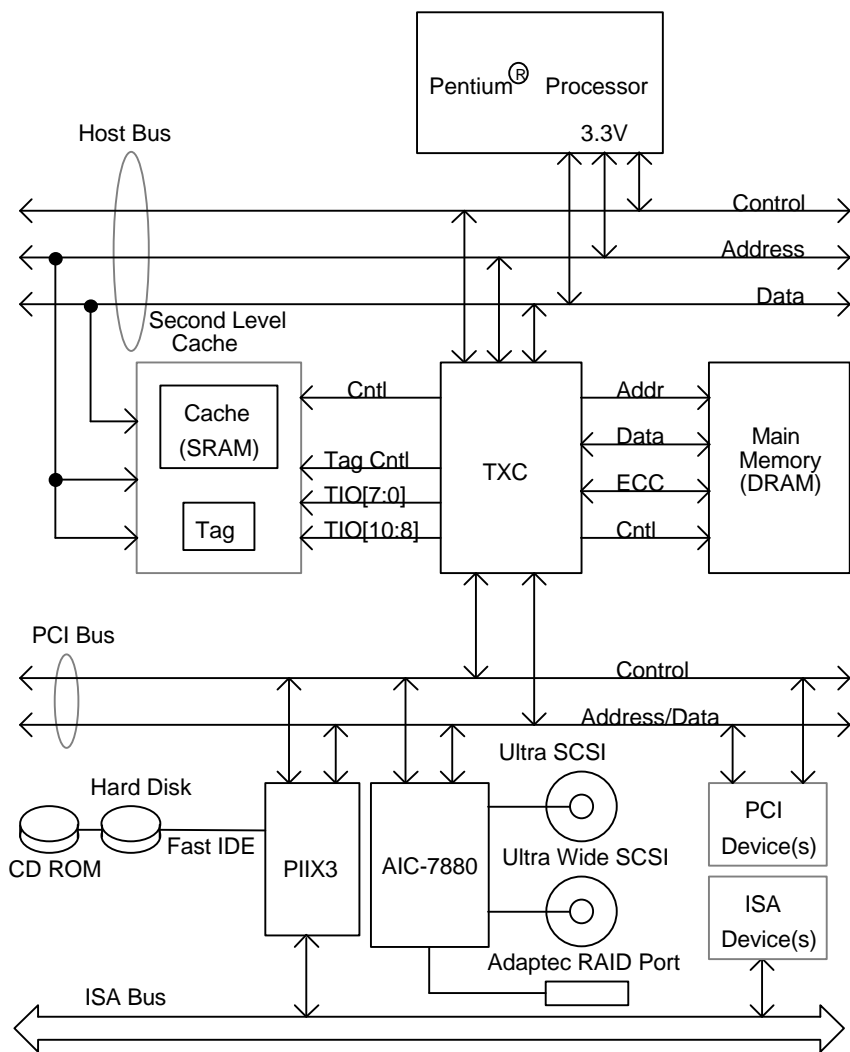

1.5. INTRODUCE THE PCI - BUS

Connecting devices to a CPU local bus can dramatically increase the speed of I/O-bound peripherals with only a slight increase in cost over traditional systems.

This price / performance point has created a vast market potential for local bus products.

The main barrier to this market has been the lack of an accepted standard for local bus peripherals.

Many mainboard and chipset manufactures developed their own local bus implementations, but they are incompatible with each other.

The VL (Video Electronics Standards Association) local bus and PCI (Peripheral Component Interconnect) bus specification was created to end this confusion.

The PCI - bus standard, under development since Jun. 1992, which is designed to bring workstation-level performance to standard PC platform. The PCI - bus removes many of the bottlenecks that have hampered PC for several years.

On the PCI - bus, peripherals operate at the native speed of the computer system, thus enabling data transfer between peripherals and the system at maximum speed.

This performance is critical for bandwidth-constrained devices such as video, multimedia, mass storage, and networking adapters.

PCI - bus standard provides end-users with a low-cost, extendible and portable local bus design, which will allow system and peripherals from different manufactures to work together.

1.6. FEATURES

- 32 bits bus transfer mode.
- Bus Master or Slave access.
- Memory burst transfer to 132 MB/sec.
- 33 MHz operation speed.
- 10 device loading ability.
- CPU independent.

2. SPECIFICATION

2.1. HARDWARE

- CPU
 - Pentium® processor 75 - 200 MHz, P55C (Dual).
 - Pentium® OverDrive® processor, (PODP).
 - AMD5K86, Cyrix6x86 processor.
 - Two 321 pins (socket 7) ZIF white socket on board.
 - 3.3V / 2.8V Dual Power Ready for P55C,Cyrix & AMD processor.
- COPROCESSOR
 - Included in Pentium.
- SPEED
 - 50 / 55 / 60 / 66 MHz system speed.
 - 25 / 27.5 / 30 / 33 PCI-Bus speed.
 - 7.5 / 8 MHz AT bus speed.
 - Hardware and Software speed switchable function.
- DRAM MEMORY
 - 2 banks 72 pins SIMM module socket on board.
 - Use 4 / 8 / 16 / 32 / 64 /128 MB 60~70 ns SIMM module DRAM.
 - 8 ~ 512 MB DRAM size.
 - Support Fast Page / EDO DRAM access mode.
- CACHE MEMORY
 - 16 KB cache memory included in Pentium.
 - 512 KB Pipeline Burst 2nd cache.
 - Support Write Back cache function for both CPU & on board cache.
- SCSI PORTS
 - Using Adaptec 7880 Ultra Wide chipset.
 - Supports one SCSI-2 or SCSI-3 (Ultra) port.
 - Support one Wide or Ultra Wide port.
 - Support Adaptec RAID Port™ on board.
- I/O BUS SLOTS
 - 4 Master / Slave PCI-BUS.
 - 4 16 bits ISA BUS.
- IDE PORTS
 - 2 Enhanced IDE channels on board.
(Using IRQ14,15)

- I/O PORTS
 - Support Mode 3,4 IDE & ATAPI CD - ROM.
 - Supports 2 16550 COM ports. (Using IRQ4, 3)
 - Supports 1 EPP/ECP LPT port. (Using IRQ7 or 5 and DMA3 or 1)
 - Supports 1 1.44MB Floppy port. (Using DMA2 & IRQ6)
 - Supports PS/2 Mouse. (Using IRQ12)
 - Supports PS/2 Keyboard.
- GREEN FUNCTION
 - Standby & Suspend mode support.
 - Green switch & LED support.
 - IDE & Display power down support.
 - Monitor all IRQ / DMA / Display / I/O events.
- BIOS
 - 128KB FLASH EEPROM.
 - Supports Plug & Play Function.
- DIMENSION
 - ATX Form Factor, 6 layers PCB.

2.2. SOFTWARE

- BIOS
 - Licensed AWARD BIOS.
 - AT CMOS Setup, BIOS / Chipset Setup, Green Setup, Hard Disk Utility included.
- O.S.
 - Operation with MS-DOS®, Windows®95, WINDOWS™ NT, OS/2, NOVELL and SCO UNIX.

2.3. ENVIRONMENT

- Ambient Temp.
 - 0°C to +50°C (Operating).
- Relative Hum.
 - 0 to +85% (Operating).
- Altitude
 - 0 to 10,000 feet (Operating).
- Vibration
 - 0 to 1,000 Hz.
- Electricity
 - 4.9 V to 5.2 V.
 - 5 A to 7 A current.

3. HARDWARE INSTALLATION

3.1. UNPACKING

The mainboard package should contain the following:

- The **GA - 586DX** mainboard.
- **USER'S MANUAL** for mainboard & SCSI Driver Installation.
- Cable set for IDE, Floppy & SCSI device.
- Diskette for **BUS MASTE IDE Driver & SCSI controller Drivers**.

The mainboard contains sensitive electric components which can be easily damaged by static electricity, so the mainboard should be left in its original packing until it is installed.

Unpacking and installation should be done on a grounded anti-static mat. The operator should be wearing an anti static wristband, grounded at the same point as the anti-static mat.

Inspect the mainboard carton for obvious damage. Shipping and handling may cause damage to your board. Be sure there are no shipping and handling damages on the board before proceeding.

After opening the mainboard carton, extract the system board and place it only on a grounded anti-static surface component side up. Again inspect the board for damage. Press down on all of the socket IC's to make sure that they are properly seated. Do this only on with the board placed on a firm flat surface.

● **DO NOT APPLY POWER TO THE BOARD IF IT HAS BEEN DAMAGED.**

You are now ready to install your mainboard. The mounting hole pattern on the mainboard matches the IBM-AT system board. It is assumed that the chassis is designed for a standard IBM XT/AT mainboard mounting.

Place the chassis on the anti-static mat and remove the cover. Take the plastic clips, Nylon stand-off and screws for mounting the system board, and keep them separate.

3.2. MAINBOARD LAYOUT

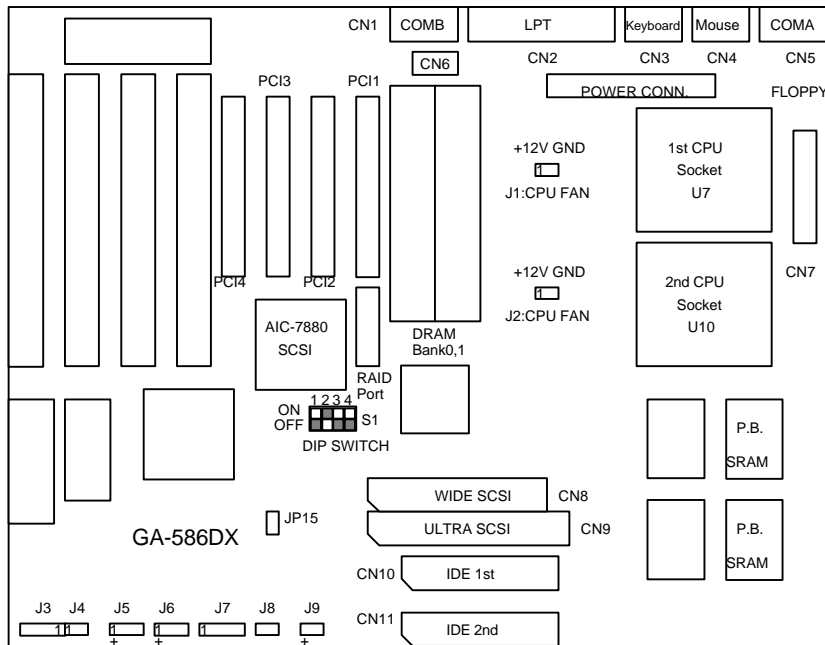

◀Figure 3.1▶

3.3. QUICK REFERENCE FOR JUMPERS & CONNECTORS

◆ J1,2: CPU cooling FAN Power Connector	
1	+12V
2	GND
◆ J3: SPEKER Connector	
Pin No.	Function
1	VCC
2	NC.
3	NC.
4	Output
◆ J4: RESET Switch (RST)	
Pin No.	Function
1	RESET Input
2	GND
◆ J5: POWER ON LED (PW-LED)	
Pin No.	Function

1	LED POWER (+)
2	NC
3	GND (-)

◆ J6: Hard Disk active LED	
Pin No.	Function
1	LED POWER (+)
2	LED POWER (-)
3	LED POWER (-)
4	LED POWER (+)

◆ J7: INFARED Connector (IR) -- Function Option	
Pin No.	Function
1	IR Data Output
2	GND
3	IR Data Input
4	NC
5	POWER (+)

◆ J8: GN-SW	
Pin No.	Function
Close	Force system to enter Green Mode (Suspend mode).
Open	Normal Operation.

◆ J9: GN-LED	
Pin No.	Function
1	LED anode (+).
2	LED cathode (-).

◆ S1: System Speed Selection		
1	2	Function
ON	ON	For 50 MHz system speed (CPU 75, 100(x2), PODP 125 MHz).
ON	OFF	For 60 MHz system speed (CPU 90, 120, 150, 180 MHz).
OFF	ON	For 66 MHz system speed (CPU 100, 133, 166, 200 MHz).
OFF	OFF	For 55 MHz system speed (CPU 110 MHz).

◆ S1: CPU INT. / EXT. FREQ. RATIO		
3	4	
OFF	OFF	x 1.5
OFF	ON	x 2
ON	ON	x 2.5
ON	OFF	x 3

◆ JP15: Wide SCSI port High Byte Terminator ON/OFF	
Pin No.	Function
Open	High Byte Terminator always Enable (ON).
Close	High Byte Terminator ON/OFF control by software.

◆ CN1-11 I/O Ports Connector	
CN1	For Serial port2 (COM B).
CN2	For LPT port.
CN3	For Keyboard I/O port.
CN4	For PS/2 Mouse port.
CN5	For Serial port1(COM A).
CN6	USB port (option).
CN7	For Floppy port
CN8	For ULTRA WIDE SCSI port.
CN9	For ULTRA 8 bit SCSI port.
CN10	For Secondary IDE port.
CN11	For Primary IDE port.

◆ Power Connector	
Pin No.	Function
1	Power Good signal
2,10,11,12	VCC (+5V)
3	+12V
4	-12V
5,6,7,8	GND
9	-5V

◆ Adaptec RAID Port	
The port is for Adaptec PCI RAID Port™ card ARO-113X, just Plug & Play will Enable onboard SCSI controller to perform as SCSI RAID channels.	

3.4. DRAM INSTALLATION

The mainboard can be installed with 4 / 8 / 16 / 32 / 64 / 128 MB 72 pins SIMM module DRAM, and the DRAM speed must be 60 or 70 ns.

The DRAM memory system on mainboard consists of bank 0 & bank 1. Each bank consist of 2 PCs 72 pins SIMM module DRAM.

Because the 72 pins SIMM module is 32 bits width, using 2 PCs which can match a 64 bits system.

The total memory size is 8 - 512 MB, and various configuration of DRAM types in the following TABLE are for reference:

Bank0	Bank1	Single: Single bank SIMM Module Ex. 4MB, 16MB, 64MB
Single	None	
Single	Single	Double: Double banks SIMM Module Ex. 8MB, 32MB, 128MB
Single	Double	
Double	None	

Double	Single
Double	Double

The DRAM installation position refer to Figure 3.1, and notice the Pin 1 of SIMM module must match with the Pin 1 of SIMM socket when the DRAM SIMM module is installed.

Insert the DRAM SIMM module into the SIMM socket at 45 degree angle. If there is a wrong direction of Pin 1, the DRAM SIMM module couldn't be inserted into socket completely.

After completely insert SIMM module into socket, then press the SIMM module in vertical direction until the left and right metal holders can keep the SIMM module standing up con-firmly.

3.5. CPU INSTALLATION AND JUMPERS SETUP

3.5.1 Uni-Processor Installation

The system's speed depends on the frequency of CLOCK GENERATOR. The user can change the DIP SWITCH (**S1**) selection to set up the system speed to 50 MHz, 55 MHz, 60 MHz or 66 MHz for 75 - 200 MHz processor.

The mainboard can use Intel Pentium® Processor, P55C or PODP (Pentium® OverDrive® Processor - P54CT, P54CTB), Cyrix 6x86 AND AMD 5k86 processor.

The CPU speed must match with the frequency of CLOCK GEN. It will cause system hanging up if the CLOCK GEN.'S frequency is higher than CPU's.

There are two CPU socket onboard, the user can install CPU to any one socket, but 1st CPU socket is recommanded for one processor configuration.

3.5.2 Dual-Processor Installation

The mainboard provide Intel Multi-processor specification, so only Intel Pentium® Processor can be used when Dual Processor configuration is achieved.

The two processor must used same speed and same type (Ex. P54C or P55C).

CPU Installation Table:

DIP SWITCH (S1)					RATIO	EXT. CLK. MHz	INT. CLK. MHz	CPU SPEED
1	2	3	4					
ON	ON	OFF	OFF	1.5	50	75	PENTIUM 75 MHz, AMD5k86-P75	
ON	OFF	OFF	OFF	1.5	60	90	PENTIUM 90 MHz, AMD5k86-P90/P120	

OFF	ON	OFF	OFF	1.5	66	100	PENTIUM 100 MHz, AMD5x86-P100/P133
ON	ON	OFF	ON	2	50	100	Cyrix 6x86-P120
OFF	OFF	OFF	ON	2	55	110	Cyrix 6x86-P133
ON	OFF	OFF	ON	2	60	120	PENTIUM 120 MHz, AMD5x86-P150, Cyrix 6x86-P150
OFF	ON	OFF	ON	2	66	133	PENTIUM 133 MHz, AMD5x86-P166, Cyrix 6x86-P166
ON	ON	ON	ON	2.5	50	125	Intel PODP 125MHz
ON	OFF	ON	ON	2.5	60	150	PENTIUM 150 MHz
OFF	ON	ON	ON	2.5	66	166	PENTIUM 166 MHz
ON	OFF	ON	OFF	3	60	180	PENTIUM 180 MHz
OFF	ON	ON	OFF	3	66	200	PENTIUM 200 MHz

- **The CPU is a sensitive electric component and it can be easily damaged by static electricity, so users must keep it away from metal surface when the CPU is installed onto mainboard.**

3.6. CMOS RTC & ISA CFG CMOS SRAM

There're RTC & CMOS SRAM on board, they have a power supply from internal battery to keep the DATA inviolate & effective.

The RTC is a REAL-TIME CLOCK device which provides the DATE & TIME to system.

The CMOS SRAM is used for keeping the information of ISA device system configuration, so the system can automatically boot OS. every time.

Due to the life-time of RTC internal battery is 5 years, the user can change a new RTC to replace old one after it can not work.

The new one's brand and type must be same with old one.

3.7. SPEAKER CONNECTOR INSTALLATION

There is always a speaker in AT system for sound purpose. The 4 - Pins connector **J3** is used to connect speaker.

The speaker can work well in both direction of connector when it is installed to the connector **J3** on mainboard.

3.8. POWER LED & KEY LOCK CONNECTOR INSTALLATION

There are a system power LED lamp on the panel of case. The power LED will light on when system is powered-on, which is connected to a 3 PIN connector. The connector should be connected to **J5** of mainboard in correct direction.

3.9. HARDWARE RESET SWITCH CONNECTOR INSTALLATION

The RESET switch on panel provides users with HARDWARE RESET function which is almost the same as power-on/off. The system will do a cold start after the RESET switch is pushed and released by user. The RESET switch is a 2 PIN connector and should be installed to **J4** on mainboard.

3.10. GREEN FUNCTION INSTALLATION

For the purpose of power saving, there are two jumpers, **J8** and **J9**, to make sure the power saving function doing well. The **J9** is a indicator (green LED) for green function. If the green LED is ON, the system is operating in green mode. The **J8** is a switch to force the system get into green mode immediately.

3.11. ATAPI DEVICE INSTALLATION

There are two Enhance PCI IDE ports (**CN10,11**) on board, which following ATAPI standard SPEC. Any one IDE port can connecte to two ATAPI devices (IDE Hard Disk, CD-ROM & Tape Driver), so total four ATAPI devices can exist in a system.

The booting Hard Disk should be the Master device of 1st IDE channel.

3.12. SCSI DEVICE INSTALLATION

There are two SCSI ports on board, One is 8bit SCSI port for SCSI-2 or ULTRA SCSI device, and total 7 8bit SCSI devices can exist in a system.

The other is 16bit SCSI port for wide or ULTRA Wide SCSI device, and total 15 SCSI devices (include 8bit SCSI device) can exist in a system.

The low byte Terminator (used for 8bit SCSI port) turning "ON" or "OFF" is controled by software (SCSI BIOS SETUP Utility), and High byte Terminaator (used for Wide SCSI port) turning ON or OFF can be controled by JP15 as following:JP15 OPEN: High byte Terminator is always enable (ON)

JP15 CLOSE:High byte Terminator is controled by software SCSI BIOS SETUP (same status as Low byte Terminator).

Terminator ON/OFF rules

CASE 1: High byte-ON (JP15 OPEN)

Low byte-ON (SCSI BIOS SETUP Enabled)

① System has 16 bit SCSI

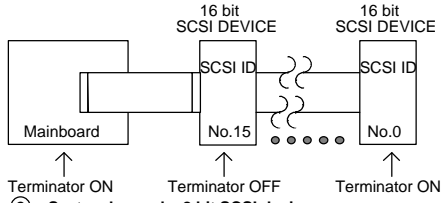

② System has only 8 bit SCSI device

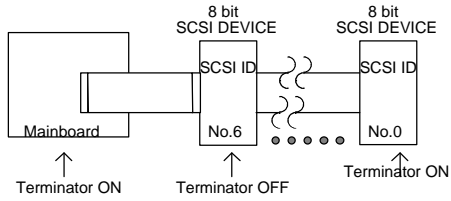

③ System has EXT. SCSI port but has not INT. SCSI device

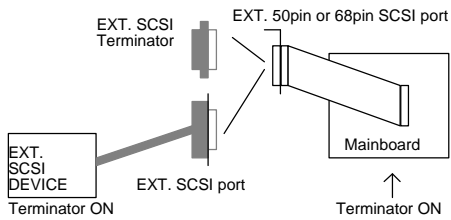

**CASE 2:High byte-ON(JP15 OPEN),
Low byte-OFF(SCSI BIOS SETUP Disabled)**

① System has 16 bit & 8 bit SCSI device

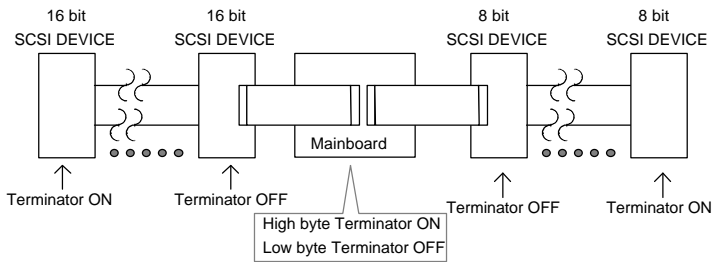

② System has 8 bit EXT. SCSI port & 8 bit INT. SCSI device

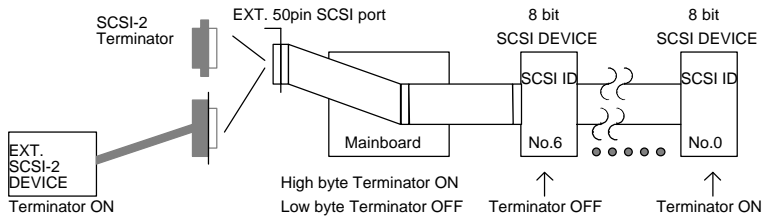

③ System has 8 bit EXT. SCSI port & 16 bit INT. SCSI device

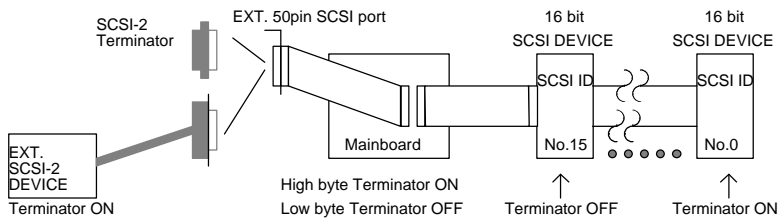

④ System has 16 bit EXT. SCSI port & 8 bit INT. SCSI device

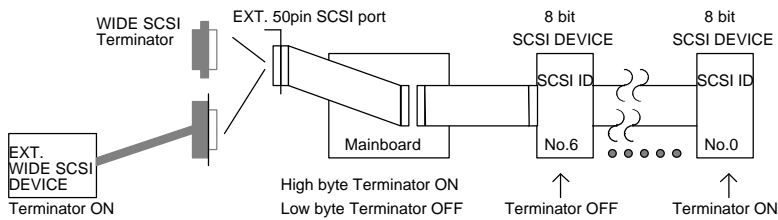

CASE 3: High byte-OFF (JP15 CLOSE)
Low byte-OFF (SCSI BIOS SETUP Disabled)

① System has 16 bit EXT. SCSI port & INT. 16 bit SCSI device

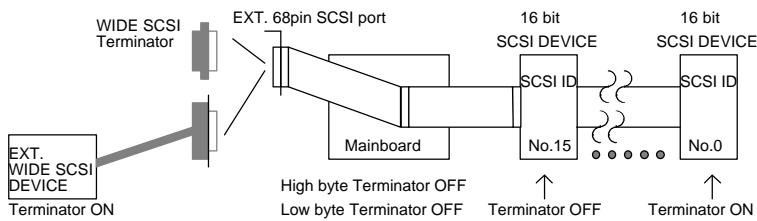

3.13. PERIPHERAL DEVICE INSTALLATION

After the I/O device installation and jumpers setup, the mainboard can be mounted into the case and fixed by screw.

To complete the mainboard installation, the peripheral device could be installed now.

The basic system needs a display interface card.

If the PCI - Bus device is to be installed in the system, any one of four PCI - Bus slots can be used if Slave PCI - Bus device being installed; any one of tree PCI-Bus slots (PCI1-PCI3) can be used if Bus Master PCI-Bus device being installed (PCI4 slot can only support Slave PCI-Bus device due to onboard SCSI controller using PCI4 slot's Master resource).

3.14. KEYBOARD & PS/2 MOUSE INSTALLATION

The main board supports PS/2 connector type keyboard & Mouse.

The BIOS will auto detect wheather the PS/2 Mouse is installed or nor & assign IRQ12 for Mouse port if which was installed.

After installing the peripheral device, the user should check everything again, and prepare to power-on the system.

3.15. KEYBOARD SETTING FUNCTION

After booting the O.S., there are some special functions used by keyboard as follows:

"CTRL_ALT_DEL"	- Pressing these keys simultaneously will cause system to Warm Start (Software Reset).
----------------	--

4. BIOS CONFIGURATION

Award's BIOS ROM has a built-in Setup program that allows users to modify the basic system configuration.

This type of information is stored in battery-backed CMOS SRAM so that it retains the Setup information when the power is turned off.

4.1. ENTERING SETUP

Power ON the computer and press immediately will allow you to enter Setup.

The other way to enter Setup is to power on the computer, when the below message appears briefly at the bottom of the screen during the POST (Power On Self Test), press key or simultaneously press <Ctrl>, <Alt>, and <Esc> keys.

- **TO ENTER SETUP BEFORE BOOT PRESS CTRL-ALT-ESC OR DEL KEY**

If the message disappears before you respond and you still wish to enter Setup, restart the system to try again by turning it OFF then ON or pressing the "RESET" button on the system case.

You may also restart by simultaneously press <Ctrl>,<Alt>, and keys.

If you do not press the keys at the correct time and the system does not boot, an error message will be displayed and you will again be asked to,

- **PRESS F1 TO CONTINUE, CTRL-ALT-ESC OR DEL TO ENTER SETUP**

4.2. CONTROL KEYS

Up arrow	Move to previous item
Down arrow	Move to next item
Left arrow	Move to the item in the left hand
Right arrow	Move to the item in the right hand
Esc key	Main Menu - Quit and not save changes into CMOS Status Page Setup Menu and Option Page Setup Menu - Exit current page and return to Main Menu
PgUp key	Increase the numeric value or make changes
PgDn key	Decrease the numeric value or make changes
F1 key	General help, only for Status Page Setup Menu and Option Page Setup Menu
F2 key	Change color from total 16 colors
F3 key	Calendar, only for Status Page Setup Menu
F4 key	Reserved
F5 key	Restore the previous CMOS value from CMOS, only for Option Page Setup Menu
F6 key	Load the default CMOS value from BIOS default table, only for Option Page Setup Menu
F7 key	Load the default
F8 key	Reserved
F9 key	Reserved
F10 key	Save all the CMOS changes, only for Main Menu

4.3. GETTING HELP

4.3.1. Main Menu

The on-line description of the highlighted setup function is displayed at the bottom of the screen.

4.3.2. Status Page Setup Menu / Option Page Setup Menu

Press F1 to pop up a small help window that describes the appropriate keys to use and the possible selections for the highlighted item. To exit the Help Window press <Esc>.

4.4. THE MAIN MENU

Once you enter Award BIOS CMOS Setup Utility, the Main Menu (Figure 4.1) will appear on the screen. The Main Menu allows you to select from seven setup functions and two exit choices. Use arrow keys to select among the items and press <Enter> to accept or enter the sub-menu.

ROM PCI / ISA BIOS
 CMOS SETUP UTILITY
 AWARD SOFTWARE, INC.

STANDARD CMOS SETUP	USER PASSWORD
BIOS FEATURES SETUP	IDE HDD AUTO DETECTION
CHIPSET FEATURES SETUP	SAVE & EXIT SETUP
POWER MANAGEMENT SETUP	EXIT WITHOUT SAVING
PNP/PCI CONFIGURATION	
INTEGRATED PERIPHERALS	
LOAD SETUP DEFAULTS	
ESC : Quit	↑ ↓ → ← : Select Item
F10 : Save & Exit Setup	(Shift)F2 : Chang Color
Time, Date, Hard Disk Type, ...	

Figure 4.1: Main Menu

- Standard CMOS setup

This setup page includes all the items in a standard compatible BIOS.

- BIOS features setup

This setup page includes all the items of Award special enhanced features.

- Chipset features setup

This setup page includes all the items of chipset special features.

- Power management setup

This setup page includes all the items of Green function features.

- PNP/PCI configuration

This setup page includes all the configurations of PCI & PNP ISA resources.

- Integrated peripherals

This setup page includes all onboard peripherals.

- Load setup defaults

BIOS defaults indicates the most appropriate value of the system parameter which the system would be in safe configuration.

- User password

Change, set, or disable password. It allows you to limit access to the system and Setup, or just to Setup.

- IDE HDD auto detection

Automatically configure hard disk parameter.

- Save & exit setup

Save CMOS value changes to CMOS and exit setup.

- Exit without save

Abandon all CMOS value changes and exit setup.

4.5. STANDARD CMOS SETUP MENU

The items in Standard CMOS Setup Menu (Figure 4.2) are divided into 9

categories. Each category includes no, one or more than one setup items. Use the arrows to highlight the item and then use the <PgUp> or <PgDn> keys to select the value you want in each item.

ROM PCI / ISA BIOS
STANDARD CMOS SETUP
AWARD SOFTWARE, INC.

Date (mm:dd:yy) : Mon, Feb 7 1994								
Time (hh:mm:ss) : 10 : 45 : 38								
HARD DISKS	TYPE	SIZE	CYLS	HEAD	PRECOMP	LANDZ	SECTOR	MODE
Primary Master	: Auto	0	0	0	0	0	0	Auto
Primary Slave	: None	0	0	0	0	0	0	-----
Secondary Master	: None	0	0	0	0	0	0	-----
Secondary Slave	: None	0	0	0	0	0	0	-----
Driver A : 1.44M , 3.5 inch.								
Driver B : None								
Floppy 3 Mode Support : Disabled								
Video : EGA/VGA								
Halt On : All Errors								
						Base Memory: 640 K		
						Extended Memory: 15360 K		
						Other Memory: 384 K		
						Total Memory: 16384 K		
ESC : Quit			↑ ↓ → ← : Select Item			PU/PD/+/- : Modify		
F1 : Help			(Shift)F2 : Chang Color					

Figure 4.2: Standard CMOS Setup Menu

- Date

The date format is <day>, <date> <month> <year>. Press <F3> to show the calendar.

day	The day, from Sun to Sat, determined by the BIOS and is display-only
date	The date, from 1 to 31 (or the maximum allowed in the month)
month	The month, Jan. through Dec.
year	The year, from 1900 through 2099

- Time

The time format in <hour> <minute> <second>.

The time is calculated base on the 24-hour military-time clock.

For example, 1 p.m. is 13:00:00.

- Primary HDDs / Secondary HDDs

The category identify the types of hard disk drive C drive F 4 devices that has been installed in the computer.

There are 45 pre-defined types and a user definable type.

Type 1 to Type 45 are pre-defined.

Type User is user-definable and type Auto will automatically detect HDD's type.

Press PgUp or PgDn to select a numbered hard disk type or type the number and press <Enter>.

Note that the specifications of your drive must match with the drive table.

The hard disk will not work properly if you enter improper information for this category.

If your hard disk drive type is not matched or listed, you can use Type User to define your own drive type manually.

If you select Type User, related information is asked to be entered to the following items.

Enter the information directly from the keyboard and press <Enter>.

Those information should be provided in the documentation form your hard disk vendor or the system manufacturer.

CYLS.	number of cylinders
HEADS	number of heads
PRECOMP	write precomp
LANDZONE	landing zone
SECTORS	number of sectors

If a hard disk has not been installed select NONE and press <Enter>.

- Drive A type / Drive B type

The category identify the types of floppy disk drive A or drive B that has been installed in the computer.

None	No floppy drive installed
------	---------------------------

360K, 5.25 in.	5-1/4 inch PC-type standard drive; 360 kilobyte capacity.
1.2M, 5.25 in.	5-1/4 inch AT-type high-density drive; 1.2 megabyte capacity (3-1/2 inch when 3 Mode is Enabled).
720K, 3.5 in.	3-1/2 inch double-sided drive; 720 kilobyte capacity
1.44M, 3.5 in.	3-1/2 inch double-sided drive; 1.44 megabyte capacity.

- Floppy 3 Mode Support (for Janpan Area)

Disable	Normal Floppy Drive.
Drive A	Drive A is 3 mode Floppy Drive.
Drive B	Drive B is 3 mode Floppy Drive.
Both	Drive A & B are 3 mode Floppy Drive.

- Video

The category detects the type of adapter used for the primary system monitor that must matches your video display card and monitor.

Although secondary monitors are supported, you do not have to select the type in setup.

EGA/VGA	Enhanced Graphics Adapter/Video Graphics Array. For EGA, VGA, SVGA, or PGA monitor adapters
CGA 40	Color Graphics Adapter, power up in 40 column mode
CGA 80	Color Graphics Adapter, power up in 80 column mode
MONO	Monochrome adapter, includes high resolution monochrome adapters

- Halt on

The category determines whether the computer will stop if an error is detected during power up.

NO errors	The system boot will not be stopped for any error that may be detected
All errors	Whenever the BIOS detects a non-fatal error the

	system will be stopped and you will be prompted
All, But Keyboard	The system boot will not stop for a keyboard error; it will stop for all other errors
All, But Diskette	The system boot will not stop for a disk error; it will stop for all other errors
All, But Disk/Key	The system boot will not stop for a keyboard or disk error; it will stop for all other errors

- **Memory**

The category is display-only which is determined by POST (Power On Self Test) of the BIOS.

Base Memory

The POST of the BIOS will determine the amount of base (or conventional) memory installed in the system.

The value of the base memory is typically 512 K for systems with 512 K memory installed on the motherboard, or 640 K for systems with 640 K or more memory installed on the motherboard.

Extended Memory

The BIOS determines how much extended memory is present during the POST.

This is the amount of memory located above 1 MB in the CPU's memory address map.

Expanded Memory

Expanded Memory in memory defined by the Lotus/Intel / Microsoft (LIM) standard as EMS.

Many standard DOS applications can not utilize memory above 640 K, the Expanded Memory Specification (EMS) swaps memory which not utilized by DOS with a section, or frame, so these applications can access all of the system memory.

Memory can be swapped by EMS is usually 64 K within 1 MB or memory above 1 MB, depends on the chipset design.

Expanded memory device driver is required to use memory as Expanded Memory.

Other Memory

This refers to the memory located in the 640 K to 1024 K address space.

This is memory that can be used for different applications.

DOS uses this area to load device drivers to keep as much base memory free for application programs. Most use for this area is Shadow RAM.

4.6. BIOS FEATURES SETUP

ROM PCI / ISA BIOS
 BIOS FEATURES SETUP
 AWARD SOFTWARE, INC.

Virus Warning	: Disabled	Video BIOS Shadow	: Enabled
CPU Internal Cache	: Enabled	C8000 - CBFFF Shadow	: Disabled
External Cache	: Enabled	CC000 - CFFFF Shadow	: Disabled
Quick Power On Self Test	: Enabled	D0000 - D3FFF Shadow	: Disabled
Boot Sequence	: A, C	D4000 - D7FFF Shadow	: Disabled
Swap Floppy Drive	: Disabled	D8000 - DBFFF Shadow	: Disabled
Boot Up Floppy Seek	: Enabled	DC000 - DFFFF Shadow	: Disabled
Boot Up NumLock Status	: On		
Typematic Rate Setting	: Disabled		
Typematic Rate (Chars/Sec)	: 6		
Typematic Delay (Msec)	:250		
Security Option	: Setup		
PCL/VGA Palette Snoop	: Disabled		
MP SPEC. For Single CPU	: Enabled		
OS Select For DRAM >64MB	: Non-OS2		
		ESC : Quit	↑ ↓ → ← : Select Item
		F1 : Help	PU/PD/+/- : Modify
		F5 : Old Values	(Shift)F2 : Color
		F7 : Load Setup Defaults	

Figure 4.3: BIOS Features Setup

- **Virus Warning**
 This category flashes on the screen.

During and after the system boots up, any attempt to write to the boot sector or partition table of the hard disk drive will halt the system and the following error message will appear, in the mean time, you can run anti-virus program to locate the problem.

Default value is Disabled.

Enabled	Activate automatically when the system boots up causing a warning message to appear when anything attempts to
---------	---

	access the boot sector or hard disk partition table
Disabled	No warning message to appear when anything attempts to access the boot sector or hard disk partition table

- CPU Internal Cache / External Cache

These two categories speed up memory access. However, it depends on CPU / chipset design.

The default value is Enabled.

Enabled	Enable cache
Disabled	Disable cache

- Quick Power On Self Test

This category speeds up Power On Self Test (POST) after you power on the computer. If it is set to Enable, BIOS will shorten or skip some check items during POST.

The default value is Enabled.

Enabled	Enable quick POST
Disabled	Normal POST

- Boot Sequence

This category determines which drive computer searches first for the disk operating system (i.e., DOS).

Default value is A,C.

A,C	System will first search for floppy disk drive then hard disk drive
C,A	System will first search for hard disk drive then floppy disk drive

- Swap Floppy Drive

The default value is Disabled.

Enabled	Floppy A & B will be swapped under DOS
Disabled	Floppy A & B will be normal definition

- Boot Up Floppy Seek

During POST, BIOS will determine if the floppy disk drive installed is 40 or 80 tracks. 360 K type is 40 tracks while 720 K, 1.2 M and 1.44 M are all 80 tracks.

The default value is Enabled.

Enabled	BIOS searches for floppy disk drive to determine if it is 40 or 80 tracks, Note that BIOS can not tell from 720 K, 1.2 M or 1.44 M drive type as they are all 80 tracks
Disabled	BIOS will not search for the type of floppy disk drive by track number. Note that there will not be any warning message if the drive installed is 360 K

- Boot Up NumLock Status

The default value is On.

On	Keypad is number keys
Off	Keypad is arrow keys

- Typematic Rate Setting

The default value is Disabled.

Enabled	Enable Keyboard typematic rate setting.
Disabled	Disable Keyboard typematic rate setting.

- Typematic Rate (Chars/Sec)

The default value is 6.

6-30	Set the maximum typematic rate from 6 chars. per second to 30 chars. per second.
------	--

- Typematic Delay (mSec)

The default value is 250.

250-1000	Set the time delay from first key to repeat the same key in to computer.
----------	--

- Security Option

This category allows you to limit access to the system and Setup, or just to Setup.

The default value is Setup.

System	The system will not boot and access to Setup will be denied if the correct password is not entered at the prompt
Setup	The system will boot, but access to Setup will be denied if the correct password is not entered at the prompt

- **To disable security, select PASSWORD SETTING at Main Menu and then you will be asked to enter password. Do not type anything and just press <Enter>, it will disable security. Once the security is disabled, the system will boot and you can enter Setup freely.**

- Video BIOS Shadow

It determines whether video BIOS will copied to RAM, however, it is optional from chipset design. Video Shadow will increase the video speed.

The default value is Enable.

Enabled	Video shadow is enabled
Disabled	Video shadow is disabled

- PCI/VGA Palette Snoop

The default value are Disabled.

Enabled	For having Video Card on ISA Bus and VGA Card on PCI Bus.
Disabled	For VGA Card only.

- MP SPEC. Fpr Single CPU

The default value are Enabled.

Enabled	The BIOS will Enabled Intel MP SPEC. for O.S. which support Intel MP SPEC. system if only one processor is installed.
Disabled	The BIOS will report standard AT system to O.S. if only one processor is installed. If two processor are installed, the BIOS always report MP SPEC. to O.S..

NOTE: Under some O.S. with standard AT system, the performance is better than the same O.S. with MP SPEC. system.

- OS Select For DRAM>64MB

The default value is Non-OS2.

Non-OS2	Using non-OS2 operating system.
OS2	Using OS2 operating system and DRAM>64MB.

- C8000 - CFFFF Shadow / D0000 - DFFFF Shadow

These categories determine whether optional ROM will be copied to RAM by 16 K byte.

The default value are Disabled.

Enabled	Optional shadow is enabled
Disabled	Optional shadow is disabled

4.7. CHIPSET FEATURES SETUP

ROM PCI / ISA BIOS
 CHIPSET FEATURES SETUP
 AWARD SOFTWARE, INC.

Auto Configuration	: 60-70ns	
Memory Hole At 15M-16M	: Disabled	
DRAM ECC/PARITY select	: ECC	
Memory Parity/ECC Check	: Disabled	
		ESC : Quit ↑ ↓ → ← : Select Item F1 : Help PU/PD/+/- : Modify F5 : Old Values (Shift)F2 : Color F7 : Load Setup Defaults

Figure 4.4: Chipset Features Setup

- Auto Configuration

The default value is 60~70ns.

60~70ns	For 60~70ns DRAM Timing.
60ns	For 60ns DRAM Timing.

- Memory Hole At 15M-16M

The default value is Disabled.

Disabled	Normal Setting.
Enabled	Set Address=15~16MB remap to ISA BUS.

- DRAM ECC/PARITY select

The default value is ECC.

ECC	Enable ECC function when using 36 bit DRAM Module.
PARITY	Enable PARITY function when using 36 bit DRAM Module.

- Memory Parity / ECC Check

The default value is Disabled.

Disabled	Disable Memory Parity or ECC check function.
Auto	BIOS will automaticly detect whether 36 bit DRAM Module

	being used, If yes, the BIOS will Enable the function.
Enabled	Enable Memory Parity or ECC check function.

4.8. POWER MANAGEMENT SETUP

ROM PCI / ISA BIOS
 POWER MANAGEMENT SETUP
 AWARD SOFTWARE, INC.

Power Management	: Enabled	** Power Down & Resume Events ** IRQ3 (COM 2) : ON IRQ4 (COM 1) : ON IRQ5 (LPT 2) : OFF IRQ6 (Floppy Disk) : ON IRQ7 (LPT 1) : OFF IRQ8 (RTC Alarm) : OFF IRQ9 (IRQ2 Redir) : OFF IRQ10 (Reserved) : OFF IRQ11 (Reserved) : OFF IRQ12 (PS/2 Mouse) : OFF IRQ14 (Hard Disk) : ON IRQ15 (Reserved) : OFF
PM Control by APM	: Yes	
Video Off Method	: DPMS	
Standby Mode	: Disabled	
Suspend Mode	: Disabled	
HDD Power Down	: Disabled	
ESC : Quit ↑ ↓ → ← : Select Item F1 : Help PU/PD/+/- : Modify F5 : Old Values (Shift)F2 : Color F7 : Load Setup Defaults		

Figure 4.5: Power Management Setup

- Power Management

The default value is Enabled.

Enabled	Enable Green function.
Disabled	Disable Green function.

Please disable Green Function for Non-S CPU in OS/2, Unix, Window NT & Novell system.

- PM Control by APM

The default value is Yes.

Yes	Enable software APM function.
No	Disable software APM function.

- Video off Method

The default value is DPMS Support.

V/H SYNC + Blank	BIOS will turn off V/H-SYNC when gets into
------------------	--

	Green mode for Green monitor power saving.
Blank Screen	BIOS will only black monitor when gets into Green mode.
DPMS Support	BIOS will use DPMS Standard to control VGA card. (The Green type VGA card will turn of V/H-SYNC automatically.)

- Standby Mode (for Network Card using)

The default value is Disable.

Disable	Disable Standby Mode.
1 min - 1 Hour	Setup the timer to enter Standby Mode.

- Suspend mode (for CPU stop clock Mode)

The default value is Disable.

Disable	Disable Suspend Mode.
1 min - 1 Hour	Setup the timer to enter Suspend Mode.

- HDD Power Down

The default value is Disable.

Disable	Disable HDD Power Down mode function.
1-15 mins	Enable HDD enter Power Down mode between 1 to 15 mins.

- IRQX (3,4,5,6,7,9,10,11,12,14,15)

The default value is On.

On	The system will return to normal mode from Green Mode when the IRQX is active.
Off	The system will not return to normal mode from Green Mode when the IRQX is active.

4.9. PNP/PCI CONFIGURATION

ROM PCI / ISA BIOS
 PNP/PCI CONFIGURATION
 AWARD SOFTWARE, INC.

Resources Controlled by	: Manual	
Reset Configuration Data	: Disabled	
IRQ-3 assigned to	: Legacy ISA	
IRQ-4 assigned to	: Legacy ISA	
IRQ-5 assigned to	: PCI/ISA PnP	
IRQ-7 assigned to	: Legacy ISA	
IRQ-9 assigned to	: PCI/ISA PnP	
IRQ-10 assigned to	: PCI/ISA PnP	
IRQ-11 assigned to	: PCI/ISA PnP	
IRQ-12 assigned to	: Legacy ISA	
IRQ-14 assigned to	: Legacy ISA	
IRQ-15 assigned to	: Legacy ISA	
DMA-0 assigned to	: PCI/ISA PnP	
DMA-1 assigned to	: PCI/ISA PnP	
DMA-3 assigned to	: PCI/ISA PnP	
DMA-5 assigned to	: PCI/ISA PnP	
DMA-6 assigned to	: PCI/ISA PnP	
DMA-7 assigned to	: PCI/ISA PnP	
		ESC : Quit ↑ ↓ → ← : Select Item F1 : Help PU/PD/+/- : Modify F5 : Old Values (Shift)F2 : Color F7 : Load Setup Defaults

Figure 4.6: PCI Slot Configuration

- Resources Controlled by
 The default value is Manual.

Manual	User can set the PnP resource (I/O Address, IRQ & DMA channels) used by legacy ISA DEVICE.
Auto	BIOS automatically use these PnP resources.

- IRQ (3,4,5,7,9,10,11,12,14,15),DMA(0,1,3,5,6,7) assigned to
 The default value is "Legacy ISA" or "PCI/ISA PnP".

Legacy ISA	The resource is used by Legacy ISA device.
PCI/ISA PnP	The resource is used by PCI/ISA PnP device (PCI or ISA).

4.10. INTEGRATED PERIPHERALS

ROM PCI / ISA BIOS
 INTEGRATED PERIPHERALS
 AWARD SOFTWARE, INC.

IDE HDD Block Mode	: Enabled	ESC : Quit ↑ ↓ → ← : Select Item F1 : Help PU/PD/+/- : Modify F5 : Old Values (Shift)F2 : Color F7 : Load Setup Defaults
PCI Slot IDE 2nd Channel	: Enabled	
On-Chip Primary PCI IDE	: Enabled	
On-Chip Secondary PCI IDE	: Enabled	
IDE Primary Master PIO	: Auto	
IDE Primary Slave PIO	: Auto	
IDE Secondary Master PIO	: Auto	
IDE Secondary Slave PIO	: Auto	
Onboard PCI SCSI chip	: Enabled	
Onboard FDD Controller	: Enabled	
Onboard Serial Port1	: COM1/3F8	
Onboard Serial Port2	: COM2/2F8	
Onboard Parallel Port	: 378H/IRQ7	
Onboard Parallel Mode	: SPP	

Figure 4.7: Load Setup Defaults

- IDE HDD Block Mode

The default value is Enabled.

Enabled	Enable IDE HDD Block Mode
Disabled	Disable IDE HDD Block Mode

- PCI Slot IDE 2nd Channel

The default value is Enabled.

Enabled	Enable PCI BUS DEVICE's 2nd IDE Channel
Disabled	Disable PCI BUS DEVICE's 2nd IDE Channel

- On-Chip Primary IDE

The default value is Enabled.

Enabled	Enable onboard 1st channel IDE port.
Disabled	Disable onboard 1st channel IDE port.

- On-Chip Secondary IDE

The default value is Enabled.

Enabled	Enable onboard 2nd channel IDE port.
Disabled	Disable onboard 2nd channel IDE port.

- IDE Primary Master PIO (for onboard IDE 1st channel).

The default value is Auto.

Auto	BIOS will automatically detect the IDE HDD Accessing mode.
Mode0~4	Manually set the IDE Accessing mode.

- IDE Primary Slave PIO (for onboard IDE 1st channel).

The default value is Auto.

Auto	BIOS will automatically detect the IDE HDD Accessing mode.
Mode0~4	Manually set the IDE Accessing mode.

- IDE Secondary Master PIO (for onboard IDE 2nd channel).

The default value is Auto.

Auto	BIOS will automatically detect the IDE HDD Accessing mode.
Mode0~4	Manually set the IDE Accessing mode.

- IDE Secondary Slave PIO (for onboard IDE 2nd channel).

The default value is Auto.

Auto	BIOS will automatically detect the IDE HDD Accessing mode.
Mode0~4	Manually set the IDE Accessing mode.

- Onboard PCI SCSI chip

The default value is Enabled.

Enabled	Enable onboard SCSI port.
Disabled	Disable onboard SCSI port.

- Onboard FDD Controller

The default value is Enabled.

Enabled	Enable onboard FDD port.
---------	--------------------------

Disabled	Disable onboard FDD port.
----------	---------------------------

- Onboard Serial Port 1

The default value is COM1/3F8.

COM1/3F8	Enable onboard Serial port A and address is 3F8H.
COM2/2F8	Enable onboard Serial port A and address is 2F8H.
COM3/3E8	Enable onboard Serial port A and address is 3E8H.
COM4/2E8	Enable onboard Serial port A and address is 2E8H.
Disabled	Disable onboard Serial port A.

- Onboard Serial Port 2

The default value is COM2/2F8.

COM1/3F8	Enable onboard Serial port B and address is 3F8H.
COM2/2F8	Enable onboard Serial port B and address is 2F8H.
COM3/3E8	Enable onboard Serial port B and address is 3E8H.
COM4/2E8	Enable onboard Serial port B and address is 2E8H.
Disabled	Disable onboard Serial port B.

- Onboard Parallel port

The default value is 378H/IRQ7.

378H	Enable onboard LPT port and address is 378H/IRQ7.
278H	Enable onboard LPT port and address is 278H/IRQ5.
Disabled	Disable onboard LPT port.
3BCH	Enable onboard LPT port and address is 3BCH/IRQ7.

- Onboard Parallel Mode

The default value is SPP.

SPP	Using Parallel port as Normal Printer Port.
EPP	Using Parallel port as Enhanced Parallel Port.
ECP	Using Parallel port as Extended Capabilities Port.
ECP+EPP	Using Parallel port as ECP & EPP mode.

4.11. LOAD SETUP DEFAULTS

4.12. USER PASSWORD

When you select this function, the following message will appear at the center of the screen to assist you in creating a password.

ENTER PASSWORD

ROM PCI / ISA BIOS
 USER PASSWORD
 AWARD SOFTWARE, INC.

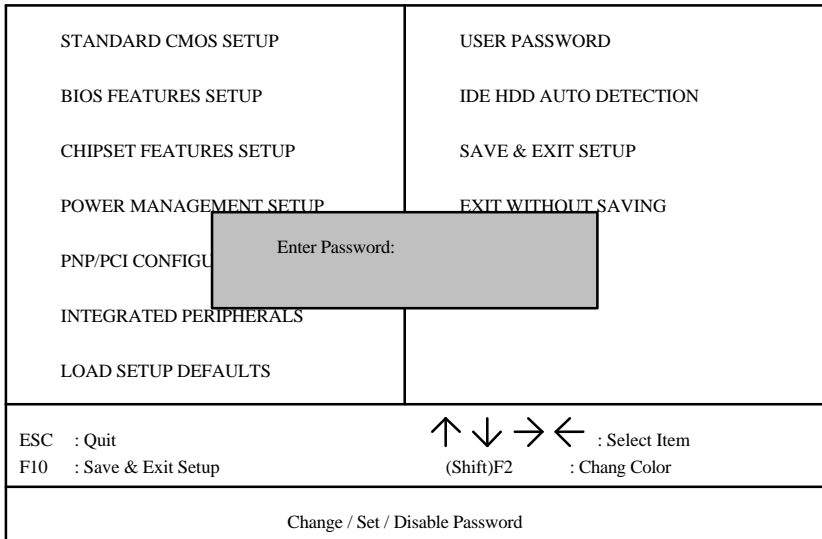

Figure 4.8: Password Setting

Type the password, up to eight characters, and press <Enter>. The password typed now will clear and previously entered password from CMOS memory. You will be asked to confirm the password. Type the password again and press <Enter>. You may also press <Esc> to abort the selection and not enter a password.

To disable password, just press <Enter> when you are prompted to enter password. A message will confirm the password being disabled. Once the password is disabled, the system will boot and you can enter Setup freely.

PASSWORD DISABLED

If you select System at Security Option of BIOS Features Setup Menu, you will be prompted for the password every time the system is rebooted or any time you try to enter Setup. If you select Setup at Security Option of BIOS Features Setup Menu, you will be prompted only when you try to enter Setup.

4.13. IDE HDD AUTO DETECTION

ROM PCI / ISA BIOS
 IDE HDD AUTO DETECTION
 AWARD SOFTWARE, INC.

HARD DISKS	TYPE	SIZE	CYLS.	HEAD	PRECOMP	LANDZ	SECTOR	MODE
Select Primary Master Option (N=Skip): N								
OPTION	SIZE	CYLS.	HEAD	PRECOMP	LANDZ	SECTOR	MODE	
1 (Y)	521	1060	16	65535	1059	63	NORMAL	
2	521	530	32	0	1059	63	LBA	
3	521	530	32	65535	1059	63	LARGE	
ESC : Skip								

Figure 4.9: IDE HDD Auto Detection

Type "Y" will accept the H.D.D. parameter reported by BIOS.

Type "N" will keep the old H.D.D. parameter setup. If the hard disk cylinder NO. is over 1024, then the user can select LBA mode or LARGER mode for DOS partition LARGE than 528 MB.

4.14. SAVE & EXIT SETUP

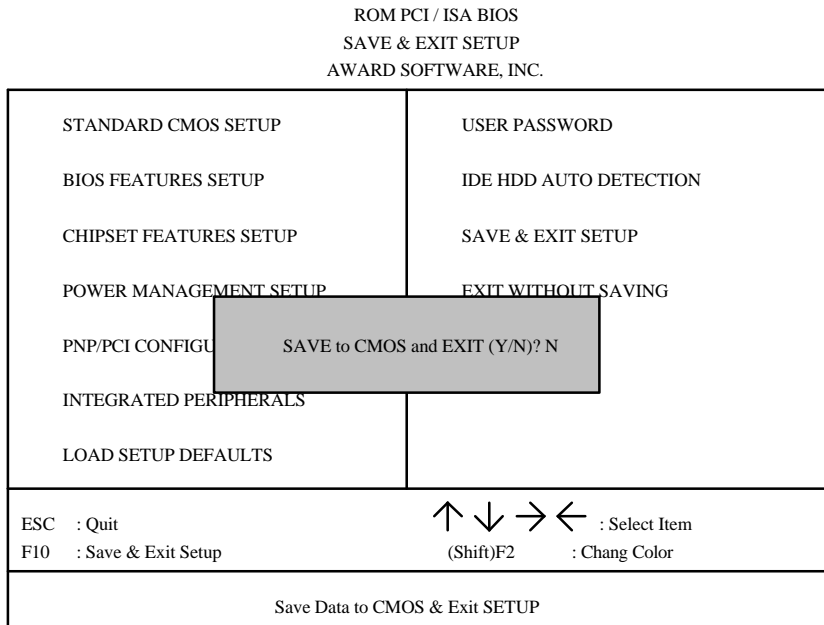

Figure 4.10: Save & Exit Setup

Type "Y" will quit the Setup Utility and save the user setup value to RTC CMOS SRAM.

Type "N" will return to Setup Utility.

4.15. EXIT WITHOUT SAVING

ROM PCI / ISA BIOS
 EXIT WITHOUT SAVING
 AWARD SOFTWARE, INC.

STANDARD CMOS SETUP	USER PASSWORD
BIOS FEATURES SETUP	IDE HDD AUTO DETECTION
CHIPSET FEATURES SETUP	SAVE & EXIT SETUP
POWER MANAGEMENT SETUP	EXIT WITHOUT SAVING
PCI CONFIGURAT	Quit Without Saving (Y/N)? N
INTEGRATED PERIPHERALS	
LOAD SETUP DEFAULTS	
ESC : Quit	↑ ↓ → ← : Select Item
F10 : Save & Exit Setup	(Shift)F2 : Chang Color
Abandon all Datas & Exit SETUP	

Figure 4.11: Exit Without Saving

Type "Y" will quit the Setup Utility without saving to RTC CMOS SRAM.

Type "N" will return to Setup Utility.

5. AT TECHNICAL INFORMATION

5.1. I/O BUS CONNECTOR PIN OUT

5.1.1. ISA SLOT PIN OUT

GND	B01	A01	-I/O CH CHK
RESET	B02	A02	SD07
+5V	B03	A03	SD06
IRQ9	B04	A04	SD05
-5V	B05	A05	SD04
DRQ2	B06	A06	SD03
-12V	B07	A07	SD02
0WS	B08	A08	SD01
+12V	B09	A09	SD00
GND	B10	A10	-I/O CH RDY
-SMEMW	B11	A11	AEN
-SMEMR	B12	A12	SA19
-IOW	B13	A13	SA18
-IOR	B14	A14	SA17
-DACK3	B15	A15	SA16
-DRQ3	B16	A16	SA15
-DACK1	B17	A17	SA14
-DRQ1	B18	A18	SA13
-REFRESH	B19	A19	SA12
BCLK	B20	A20	SA11
IRQ7	B21	A21	SA10
IRQ6	B22	A22	SA09
IRQ5	B23	A23	SA08
IRQ4	B24	A24	SA07
IRQ3	B25	A25	SA06
-DACK2	B26	A26	SA05
T/C	B27	A27	SA04
BALE	B28	A28	SA03
+5V	B29	A29	SA02
OSC	B30	A30	SA01
GND	B31	A31	SA00
-MEMCS16	D01	C01	SBHE
-I/OCS16	D02	C02	LA23
IRQ10	D03	C03	LA22
IRQ11	D04	C04	LA21
IRQ12	D05	C05	LA20
IRQ15	D06	C06	LA19
IRQ14	D07	C07	LA18
-DACK0	D08	C08	LA17
DRQ0	D09	C09	-MEMR
-DACK5	D10	C10	-MEMW
DRQ5	D11	C11	SD08
-DACK6	D12	C12	SD09
DRQ6	D13	C13	SD10
-DACK7	D14	C14	SD11
DRQ7	D15	C15	SD12
+5V	D16	C16	SD13
-MASTER	D17	C17	SD14
GND	D18	C18	SD15

5.1.2. PCI - BUS SLOT PIN OUT

-12V	B01	A01	NC
NC	B02	A02	+12V
GND	B03	A03	NC
NC	B04	A04	NC
VCC	B05	A05	VCC
VCC	B06	A06	INTA#
INTB#	B07	A07	INTC#
INTD#	B08	A08	VCC
PST#1	B09	A09	NC
NC	B10	A10	VCC
PST#2	B11	A11	NC
GND	B12	A12	GND
GND	B13	A13	GND
NC	B14	A14	NC
GND	B15	A15	RST#
CLK	B16	A16	VCC
GND	B17	A17	GNT#
REQ#	B18	A18	GND
VCC	B19	A19	NC
AD_31	B20	A20	AD_30
AD_29	B21	A21	NC
GND	B22	A22	AD_28
AD_27	B23	A23	AD_26
AD_25	B24	A24	GND
NC	B25	A25	AD_24
CBE#3	B26	A26	IDSEL
AD_23	B27	A27	NC
GND	B28	A28	AD_22
AD_21	B29	A29	AD_20
AD_19	B30	A30	GND
NC	B31	A31	AD_18
AD_17	B32	A32	AD_16
CEB#2	B33	A33	NC
GND	B34	A34	FRAME#
IRDY#	B35	A35	GND
NC	B36	A36	TRDY#
DEVSEL#	B37	A37	GND
GND	B38	A38	STOP#
LOCK#	B39	A39	NC
PERR#	B40	A40	SDONE
NC	B41	A41	SBO#
SERR#	B42	A42	GND
NC	B43	A43	PAR
CBE#1	B44	A44	AD_15
AD_14	B45	A45	NC
GND	B46	A46	AD_13
AD_12	B47	A47	AD_11
AD_10	B48	A48	GND
GND	B49	A49	AD_09
AD_08	B52	A52	CBE#0
AD_07	B53	A53	NC
NC	B54	A54	AD_06
AD_05	B55	A55	AD_04
AD_03	B56	A56	GND
GND	B57	A57	AD_02
AD_01	B58	A58	AD_00
VCC	B59	A59	VCC
NC	B60	A60	NC
VCC	B61	A61	VCC
VCC	B62	A62	VCC

5.2. I/O & MEMORY MAP

MEMORY MAP:	[0000000-009FFFFF]	System memory used by DOS and application program.
	[00A0000-00BFFFFF]	Display buffer memory for VGA/ EGA/CGA/MONOCHROME adapter.
	[00C0000-00DFFFFF]	Reserved for I/O device BIOS ROM or RAM buffer.
	[00E0000-00EFFFFF]	Reserved for PCI device ROM.
	[00F0000-00FFFFFF]	System BIOS ROM.
	[0100000-BFFFFFFF]	System extension memory.
IO MAP:	[000-01F]	DMA controller.(Master)
	[020-021]	INTERRUPT controller.(Master)
	[022-023]	CHIPSET control registers I/O ports.
	[040-05F]	TIMER control registers.
	[060-06F]	KEYBOARD interface controller.(8042)
	[070-07F]	RTC ports & CMOS I/O ports.
	[080-09F]	DMA register.
	[0A0-0BF]	INTERRUPT controller.(Slave)
	[0C0-0DF]	DMA controller.(Slave)
	[0F0-0FF]	MATH COPROCESSOR
	[1F0-1F8]	HARD DISK controller.
	[278-27F]	PARALLEL port-2.
	[2B0-2DF]	GRAPHICS adapter controller.
	[2F8-2FF]	SERIAL port-2.
	[360-36F]	NETWORK ports.
	[378-37F]	PARALLEL port-1
	[3B0-3BF]	MONOCHROME & PRINTER adapter.
	[3C0-3CF]	EGA adapter.
	[3D0-3DF]	CGA adapter.
	[3F0-3F7]	FLOPPY DISK controller.
	[3F8-3FF]	SERIAL port-1.

5.3. TIMER & DMA CHANNELS MAP

TIMER MAP:	TIMER Channel-0 System timer interrupt
	TIMER Channel-1 DRAM REFRESH request
	TIMER Channel-2 SPEAKER tone generator
DMA CHANNELS:	DMA Channel-0 Available
	DMA Channel-1 IBM SDLC
	DMA Channel-2 FLOPPY DISK adapter
	DMA Channel-3 Available
	DMA Channel-4 Cascade for DMA controller 1
	DMA Channel-5 Available
	DMA Channel-6 Available
	DMA Channel-7 Available

5.4. INTERRUPT MAP

NMI: Parity check error

IRQ (H/W): 0 System TIMER interrupt from TIMER-0

1 KEYBOARD output buffer full

2 Cascade for IRQ 8-15

3 SERIAL port 2

4 SERIAL port 1

5 PARALLEL port 2

6 FLOPPY DISK adapter

7 PARALLEL port 1

8 RTC clock

9 Available

10 Available

11 Available

12 Available

13 MATH coprocessor

14 HARD DISK adapter

15 Available

5.5. RTC & CMOS RAM MAP

RTC & CMOS:	00	Seconds
	01	Second alarm
	02	Minutes
	03	Minutes alarm
	04	Hours
	05	Hours alarm
	06	Day of week
	07	Day of month
	08	Month
	09	Year
	0A	Status register A
	0B	Status register B
	0C	Status register C
	0D	Status register D
	0E	Diagnostic status byte
	0F	Shutdown byte
	10	FLOPPY DISK drive type byte
	11	Reserve
	12	HARD DISK type byte
	13	Reserve
	14	Equipment byte
	15	Base memory low byte
	16	Base memory high byte
	17	Extension memory low byte
	18	Extension memory high byte
	19-2d	
	2E-2F	
	30	Reserved for extension memory low byte
	31	Reserved for extension memory high byte
	32	DATE CENTURY byte
	33	INFORMATION FLAG
	34-3F	Reserve
	40-7f	Reserved for CHIPSET SETTING DATA

APPENDIX A: POST MESSAGE

When the BIOS encounters an error that requires the user to correct something, either a beep code will sound or a message will be displayed in a box in the middle of the screen and the message PRESS F1 TO CONTINUE, CTRL-ALT-ESC OR DEL TO ENTER SETUP will be shown in the information box at the bottom.

- POST BEEP

Currently there is only one beep code in BIOS. This code indicates that a video error has occurred and the BIOS cannot initialize the video screen to display any additional information. This beep code consists of a single long beep followed by two short beeps.

- ERROR MESSAGE

Once or more of the following messages may be displayed if the BIOS detects an error during the POST. This list includes message for both the ISA and the EISA BIOS.

- ☒ CMOS BATTERY HAS FAILED

CMOS battery is no longer functional. It should be replaced.

- ☒ CMOS CHECKSUM ERROR

Checksum of CMOS is incorrect. This can indicate that CMOS has become corrupt. This error may have been caused by a weak battery. Check the battery and replace if necessary.

- ☒ DISK BOOT FAILURE, INSERT SYSTEM DISK AND PRESS ENTER

No boot device was found. Insert a system disk into Drive A: and press <Enter>. If you assumed the system would boot from the hard drive, make sure the controller is inserted correctly and all cables are properly attached. Also be sure the disk is formatted as a boot device. Then reboot the system.

- ☒ DISKETTE DRIVES OR TYPES MISMATCH ERROR - RUN SETUP

Type of diskette drive installed in the system is different from the CMOS definition. Run Setup to re-configure the drive type correctly.

- ☒ DISPLAY SWITCH IS SET INCORRECTLY

Display switch on the motherboard can be set to either monochrome or color. This indicates the switch is set to a different setting than indicated in Setup. Determine which setting is correct, and then either turn off the system and change the jumper, or enter Setup and change the VIDEO selection.

- ⊗ DISPLAY TYPE HAS CHANGED SINCE LAST BOOT
Since last powering off the system, the display adapter has been changed. You must configure the system for the new display type.
- ⊗ EISA Configuration Checksum Error
PLEASE RUN EISA CONFIGURATION UTILITY
The EISA non-volatile RAM checksum is incorrect or cannot correctly read the EISA slot. This can indicate either the EISA non-volatile memory has become corrupt or the slot has configured incorrectly. Also be sure the card is installed firmly in the slot.
- ⊗ EISA Configuration Is Not Complete
PLEASE RUN EISA CONFIGURATION UTILITY
The slot configuration information stored in the EISA non-volatile memory is incomplete.
☞ When either of these errors appear, the system will boot in ISA mode, which allows you to run the EISA Configuration Utility.
- ⊗ ERROR ENCOUNTERED INITIALIZING HARD DRIVE
Hard drive cannot be initialized. Be sure the adapter is installed correctly and all cables are correctly and firmly attached. Also be sure the correct hard drive type is selected in Setup.
- ⊗ ERROR INITIALIZING HARD DISK CONTROLLER
Cannot initialize controller. Make sure the cord is correctly and firmly installed in the bus. Be sure the correct hard drive type is selected in Setup. Also check to see if any jumper needs to be set correctly in the hard drive.
- ⊗ FLOPPY DISK CNTRLR ERROR OR NO CNTRLR PRESENT
Cannot find or initialize the floppy drive controller. Make sure the controller is installed correctly and firmly. If there are no floppy drives installed, be sure the Diskette Drive selection in Setup is set to NONE.
- ⊗ Invalid EISA Configuration
PLEASE RUN EISA CONFIGURATION UTILITY
The non-volatile memory containing EISA configuration information was programmed incorrectly or has become corrupt. Re-run EISA configuration utility to correctly program the memory.
☞ When this error appears, the system will boot in ISA mode, which allows you to run the EISA Configuration Utility.

⊗ KEYBOARD ERROR OR NO KEYBOARD PRESENT

Cannot initialize the keyboard. Make sure the keyboard is attached correctly and no keys are being pressed during the boot.

If you are purposely configuring the system without a keyboard, set the error halt condition in Setup to HALT ON ALL, BUT KEYBOARD. This will cause the BIOS to ignore the missing keyboard and continue the boot.

⊗ Memory Address Error at ...

Indicates a memory address error at a specific location. You can use this location along with the memory map for your system to find and replace the bad memory chips.

⊗ Memory parity Error at ...

Indicates a memory parity error at a specific location. You can use this location along with the memory map for your system to find and replace the bad memory chips.

⊗ MEMORY SIZE HAS CHANGED SINCE LAST BOOT

Memory has been added or removed since the last boot. In EISA mode use Configuration Utility to re-configure the memory configuration. In ISA mode enter Setup and enter the new memory size in the memory fields.

⊗ Memory Verify Error at ...

Indicates an error verifying a value already written to memory. Use the location along with your system's memory map to locate the bad chip.

⊗ OFFENDING ADDRESS NOT FOUND

This message is used in conjunction with the I/O CHANNEL CHECK and RAM PARITY ERROR messages when the segment that has caused the problem cannot be isolated.

⊗ OFFENDING SEGMENT:

This message is used in conjunction with the I/O CHANNEL CHECK and RAM PARITY ERROR messages when the segment that has caused the problem has been isolated.

⊗ PRESS A KEY TO REBOOT

This will be displayed at the bottom screen when an error occurs that requires you to reboot. Press any key and the system will reboot.

⊗ PRESS F1 TO DISABLE NMI, F2 TO REBOOT

When BIOS detects a Non-maskable Interrupt condition during boot, this will allow you to disable the NMI and continue to boot, or you can reboot the system with the NMI enabled.

⊗ RAM PARITY ERROR - CHECKING FOR SEGMENT ...

Indicates a parity error in Random Access Memory.

⊗ Should Be Empty But EISA Board Found

PLEASE RUN EISA CONFIGURATION UTILITY

A valid board ID was found in a slot that was configured as having no board ID.

☞ When this error appears, the system will boot in ISA mode, which allows you to run the EISA Configuration Utility.

⊗ Should Have EISA Board But Not Found

PLEASE RUN EISA CONFIGURATION UTILITY

The board installed is not responding to the ID request, or no board ID has been found in the indicated slot.

☞ When this error appears, the system will boot in ISA mode, which allows you to run the EISA Configuration Utility.

⊗ Slot Not Empty

Indicates that a slot designated as empty by the EISA Configuration Utility actually contains a board.

☞ When this error appears, the system will boot in ISA mode, which allows you to run the EISA Configuration Utility.

⊗ SYSTEM HALTED, (CTRL-ALT-DEL) TO REBOOT ...

Indicates the present boot attempt has been aborted and the system must be rebooted. Press and hold down the CTRL and ALT keys and press DEL.

⊗ Wrong Board In Slot

PLEASE RUN EISA CONFIGURATION UTILITY

The board ID does not match the ID stored in the EISA non-volatile memory.

☞ When this error appears, the system will boot in ISA mode, which allows you to run the EISA Configuration Utility.

APPENDIX B: POST CODES

☞ EISA POST codes are typically output to port address 300h. ISA POST codes are typically output to port address 80h.

POST	Name	Description
C0	Turn Off Chipset Cache	OEM Specific-Cache control.
1	Processor Test 1	Processor Status (1 FLAGS) Verification. Test the following processor status flags carry, zero, sign, overflow, The BIOS will set each of these flags, verify they are set, then turn each flag off and verify it is off.
2	Processor Test 2	Read/Write/Verify all CPU registers except SS, SP, and BP with data pattern FF and 00.
3	Initialize Chips	Disable NMI, PIE, AIE, UEI, SQWV. Disable video, parity checking, DMA. Reset math coprocessor. Clear all page registers, CMOS shutdown byte. Initialize timer 0, 1, and 2, including set EISA timer to a known state. Initialize DMA controllers 0 and 1. Initialize interrupt controllers 0 and 1. Initialize EISA extended registers.
4	Test Memory Refresh Toggle	RAM must be periodically refreshed in order to keep the memory from decaying. This function assures that the memory refresh function is working properly.
5	Blank video, Initialize keyboard	Keyboard controller initialization.
6	Reserved	
7	Test CMOS Interface and Battery Status	Verifies CMOS is working correctly, detects bad battery.
BE	Chipset Default Initialization	Program chipset registers with power on BIOS defaults.
C1	Memory presence test	OEM Specific-Test to size on-board memory.
C5	Early Shadow	OEM Specific-Early Shadow enable for fast boot.
C6	Cache presence test	External cache size detection.
8	Setup low memory	Early chip set initialization. Memory presence test.

Appendix B: Post Codes

		OEM chip set routines. Clear low 64 K of memory. Test first 64 K memory.
9	Early Cache Initialization	Cyrix CPU initialization. Cache initialization.
A	Setup Interrupt Vector Table	Initialize first 120 interrupt vectors with SPURIOUS_INT-HDLR and initialize INT 00h-1Fh according to INT_TBL.
B	Test CMOS RAM Checksum	Test CMOS RAM Checksum, if bad, or insert key pressed, load defaults.
C	Initialize keyboard	Detect type of keyboard controller (optional). Set NUM_LOCK status.
D	Initialize Video Interface	Detect CPU clock. Read CMOS location 14h to find out type of video in use. Detect and Initialize Video Adapter.
E	Test Video Memory	Test video memory, write sign-on message to screen. Setup shadow RAM - Enable shadow according to Setup.
F	Test DMA Controller 0	BIOS checksum test. Keyboard detect and initialization.
10	Test DMA Controller 1	
11	Test DMA Page registers	Test DMA Page Registers.
12-13	Reserved	
14	Test Timer Counter 2	Test 8254 Timer 0 Counter 2.
15	Test 8259-1 Mask Bits	Verify 8259 Channel 1 masked interrupts by alternately turning off and on the interrupt lines.
16	Test 8259-2 Mask Bits	Verify 8259 Channel 2 masked interrupts by alternately turning off and on the interrupt lines.
17	Test Stuck 8259's Interrupt Bits	Turn off interrupts then verify no interrupt mask register is on.
18	Test 8259 Interrupt Functionality	Force an interrupt and verify the interrupt occurred.
19	Test Stuck NMI Bits (Parity/IO Check)	Verify NMI can be cleared.
1A		Display CPU clock.

1B-1E	Reserved	
1F	Set EISA Mode	If EISA non-volatile memory checksum is good, execute EISA initialization. If not, execute ISA tests an clear EISA mode flag. Test EISA Configuration Memory Integrity (checksum & communication interface).
20	Enable Slot 0	Initialize slot 0 (System Board).
21-2F	Enable Slots 1-15	Initialize slot 1 through 15.
30	Size Base and Extended Memory	Size base memory from 256 K to 640 K extended memory above 1 MB.
31	Test Base and Extended Memory	Test base memory from 256 K to 640 K and extended memory above 1 MB using various patterns. ☞ This will be skipped in EISA mode and can be "skipped" with ESC key in ISA mode.
32	Test EISA Extended Memory	If EISA Mode flag is set then test EISA memory found in slots initialization. ☞ This will be skipped in ISA mode and can be "skipped" with ESC key in EISA mode.
33-3B	Reserved	
3C	Setup Enabled	
3D	Initialize & Install Mouse	Detect if mouse is present, initialize mouse, install interrupt vectors.
3E	Setup Cache Controller	Initialize cache controller.
3F	Reserved	
BF	Chipset Initialization	Program chipset registers with Setup values.
40		Display virus protest disable or enable.
41	Initialize Floppy Drive & Controller	Initialize floppy disk drive controller and any drives.
42	Initialize Hard Drive & Controller	Initialize hard drive controller and any drives.
43	Detect & Initialize Serial/Parallel Ports	Initialize any serial and parallel ports (also game port).
44	Reserved	
45	Detect & Initialize Math Coprocessor	Initialize math coprocessor.
46	Reserved	
47	Reserved	

Appendix B: Post Codes

48-4D	Reserved	
4E	Manufacturing POST Loop or Display Messages	Reboot if Manufacturing POST Loop pin is set. Otherwise display any messages (i.e., any non-fatal errors that were detected during POST) and enter Setup.
4F	Security Check	Ask password security (optional).
50	Write CMOS	Write all CMOS values back to RAM and clear screen.
51	Pre-boot Enable	Enable parity checker. Enable NMI, Enable cache before boot.
52	Initialize Option ROMs	Initialize any option ROMs present from C8000h to EFFFFh. ☞ When FSCAN option is enabled, will initialize from C8000h to F7FFFh.
53	Initialize Time Value	Initialize time value in 40h: BIOS area.
60	Setup Virus Protect	Setup virus protect according to Setup
61	Set Boot Speed	Set system speed for boot
62	Setup NumLock	Setup NumLock status according to Setup
63	Boot Attempt	Set low stack. Boot via INT 19h.
B0	Spurious	If interrupt occurs in protected mode.
B1	Unclaimed NMI	If unmasked NMI occurs, display Press F1 to disable NMI, F2 reboot.
E1-EF	Setup Pages	E1 - Page 1, E2 - Page 2, etc.
FF	Boot	

APPENDIX C: BIOS DEFAULT DRIVE TABLE

Type	Size (MB)	Cylinders	Heads	Sectors	Write / Precomp	Land Zone	Example Model
1	10 MB	306	4	17	128	305	TEAC SD510 MMI 112, 5412
2	20 MB	615	4	17	300	615	Seagate ST225, ST4026
3	31 MB	615	6	17	300	615	
4	62 MB	940	8	17	512	940	
5	47 MB	940	6	17	512	940	
6	20 MB	615	4	17	65535	615	Seagate ST125 Tandon TM262
7	31 MB	462	8	17	256	511	
8	30 MB	733	5	17	65535	733	Tandon TM703
9	112 MB	900	15	17	65535	901	
10	20 MB	820	3	17	65535	820	
11	35 MB	855	5	17	65535	855	
12	50 MB	855	7	17	65535	855	
13	20 MB	306	8	17	128	319	Disctron526, MMI M125
14	43 MB	733	7	17	65535	733	
16	20 MB	612	4	17	0	663	Microscience HH725 Syquest3250, 3425
17	41 MB	977	5	17	300	977	
18	57 MB	977	7	17	65535	977	
19	60 MB	1024	7	17	512	1023	
20	30 MB	733	5	17	300	732	
21	43 MB	733	7	17	300	732	
22	30 MB	733	5	17	300	733	Seagate ST4038
23	10 MB	306	4	17	0	336	
24	54 MB	925	7	17	0	925	Seagate ST4051
25	69 MB	925	9	17	65535	925	Seagate ST4096
26	44 MB	754	7	17	754	754	Maxtor2085

Appendix C: BIOS Default Drive Table

27	69 MB	754	11	17	65535	754	Maxtor2140, Priam S14
28	41 MB	699	7	17	256	699	Maxtor2190, Priam S19
29	68 MB	823	10	17	65535	823	Maxtor1085 Micropolis1325
30	53 MB	918	7	17	918	918	Maxtor1105, 1120, 4780
31	94 MB	1024	11	17	65535	1024	Maxtor1170
32	128 MB	1024	15	17	65535	1024	CDC9415
33	43 MB	1024	5	17	1024	1024	
34	10 MB	612	2	17	128	612	
35	77 MB	1024	9	17	65535	1024	
36	68 MB	1024	8	17	512	1024	
37	41 MB	615	8	17	128	615	
38	25 MB	987	3	17	987	987	
39	57 MB	987	7	17	987	987	Maxtor1140, 4380
40	41 MB	820	6	17	820	820	Seagate ST251
41	41 MB	977	5	17	977	977	Seagate ST4053 Miniscribe3053/ 6053
42	41 MB	981	5	17	981	981	Miniscribe3053/ 6053 RLL
43	48 MB	830	7	17	512	830	Miniscribe 3650
44	69 MB	830	10	17	65535	830	Miniscribe 3650 RLL
45	114 MB	917	15	17	65535	918	Conner CP3104
46	152 MB	1224	15	17	65535	1223	Conner CP3204
User							

APPENDIX D: PROBLEM SHEET

1. Customer Data

Name
Address
Tel. No.
Fax. No.
Purchase Date

2. Mainboard Data

Model NO. GA-
Serial No. Rev. No.

3. System Configuration

CPU Type:
CPU Brand:
CPU Speed:
DRAM Type: 1 2 4 8 16 32 MB
DRAM Speed: 80 70 60 ns
DRAM Total Size: MB
DRAM Brand:
SRAM Size: 64KB 128 KB 256 KB 512 KB
SRAM Part No. TAG: DATA:
Video Card:
Video Chip or Brand:
Floppy Drive A Capacity & Brand:
Floppy Drive B Capacity & Brand:
Storage Controller Type MFM RLL IDE EDSI SCSI
Hard Drive C Brand & Type:
Hard Drive D Brand & Type:
LAN Controller Type:
LAN Card Brand & Model:
Serial / Parallel Chip Brand & Model:
Mouse Brand & Model:
O.S. DOS OS/2 NETWARE UNIX / XENIX Ver.:

4. AUTOEXEC.BAT & CONFIG.SYS File:

5. Problem Description:

R-01-03 -061001