Copyright and Warranty Notice

The information in this document is subject to change without notice and does not represent a commitment on part of the vendor, who assumes no liability or responsibility for any errors that may appear in this manual.

No warranty or representation, either expressed or implied, is made with respect to the quality, accuracy or fitness for any particular part of this document. In no event shall the manufacturer be liable for direct, indirect, special, incidental or consequential damages arising from any defect or error in this manual or product.

Product names appearing in this manual are for identification purpose only and trademarks and product names or brand names appearing in this document are the property of their respective owners.

This document contains materials protected under International Copyright Laws. All rights reserved. No part of this manual may be reproduced, transmitted or transcribed without the expressed written permission of the manufacturer and authors of this manual.

If you do not properly set the motherboard settings, causing the motherboard to malfunction or fail, we cannot guarantee any responsibility.

KX7-333/KX7-333R Motherboard User's Manual

Index

CHAPTER 1.	INTRODUCTION OF KX7-333/KX7-333R FEATURES	1-1
1-1.	FEATURES OF KX7-333/KX7-333R MOTHERBOARD	1-1
1-2.	SPECIFICATIONS	1-2
1-3.	ITEM CHECKLIST	1-3
1-4.	LAYOUT DIAGRAM FOR KX7-333/KX7-333R	1-4
CHAPTER 2.	INSTALLING THE MOTHERBOARD	2-1
2-1.	INSTALLATION OF THE AMD ATHLON™ XP, ATHLON™ AND DURON™ CPU	2-2
2-2.	INSTALLING THE MOTHERBOARD TO THE CHASSIS	2-5
2-3.	INSTALLING SYSTEM MEMORY	2-6
2-4.	CONNECTORS, HEADERS AND SWITCHES	2-7
CHAPTER 3.	INTRODUCING THE BIOS	3-1
3-1.	CPU SETUP [SOFT MENU™ III]	3-3
3-2.	STANDARD CMOS FEATURES SETUP MENU	3-6
3-3.	ADVANCED BIOS FEATURES SETUP MENU	3-9
3-4.	ADVANCED CHIPSET FEATURES SETUP MENU	3-13
3-5.	INTEGRATED PERIPHERALS	3-21
3-6.	POWER MANAGEMENT SETUP MENU	3-25
3-7.	PNP/PCI CONFIGURATIONS SETUP MENU	3-31
3-8.	PC HEALTH STATUS	3-34
3-9.	LOAD FAIL-SAFE DEFAULTS	3-35
3-10.	LOAD OPTIMIZED DEFAULTS	3-35
3-11.	SET PASSWORD	3-36
3-12.	SAVE & EXIT SETUP	3-36
3-13.	EXIT WITHOUT SAVING	3-36
CHAPTER 4.	RAID SETTING GUIDE	4-1
4-1.	THE FEATURES OF RAID ON THE KX7-333R	4-1
4-2.	RAID SETUP ON THE KX7-333R	4-1
4-3.	THE BIOS SETTING MENU	4-2
CHAPTER 5.	HPT 372 DRIVER INSTALLATION	5-1
5-1.	DOS®	5-1
5-2.	WINDOWS® 98 SE	5-1
5-3.	WINDOWS® 2000	5-3
CHAPTER 6.	HPT 372 RAID MANAGEMENT SOFTWARE INSTALLATION GUIDE FOR WINDOWS® 2000	6-1
APPENDIX A.	VIA 4 IN 1 DRIVERS INSTALLATION FOR WINDOWS® 98 SE & WINDOWS® 2000	A-1
APPENDIX B.	INSTALLING THE HARDWARE MONITOR SYSTEM	B-1

<i>APPENDIX C.</i>	<i>BIOS UPDATE GUIDE</i>	<i>C-1</i>
<i>APPENDIX D.</i>	<i>TROUBLESHOOTING (NEED ASSISTANCE?)</i>	<i>D-1</i>
<i>APPENDIX E.</i>	<i>HOW TO GET TECHNICAL SUPPORT.....</i>	<i>E-1</i>

Chapter 1. Introduction of KX7-333/KX7-333R Features

1-1. Features of KX7-333/KX7-333R Motherboard

This motherboard is designed for AMD Socket A Athlon™ XP, Athlon™ and Duron™ processors. It supports the AMD Socket-A structure, with up to 3 GB (**Unbuffered**) or 3.5 GB (**Registered**) of memory, super I/O and Green PC functions.

The KX7-333/KX7-333R uses the VIA KT333 and VT8233A chipsets to make the evolutionary move from PC 100/PC 133 SDRAM to PC 1600/PC 2100/PC 2700 DDR SDRAM, increasing the speed of the system and memory buses from 100 MHz to 166 MHz. Its 200/266/333 MHz memory interface supports a wide range of PC 1600/PC 2100/PC 2700 DDR SDRAM memory devices now on the market.

VIA KT333 is a system bus controller, or northbridge, that houses the high-speed system elements critical to overall system performance while also containing the system interface to the processor. The key functions of the KT333 System Controller include the 266 MHz Athlon System Bus, the 333 MHz DDR Memory Subsystem, the AGP 4X/2X/1X modes Graphics Interface (AGP 2.0 Compliant) and the 33 MHz/32-bit PCI Bus Interface (PCI 2.2 Compliant), including arbiter.

DDR SDRAM is the newest memory standard, it provides the maximum translation bandwidth and also greatly improves data transaction delays. This feature improves whole system performance and speed, especially multimedia environment applications.

The KX7-333/KX7-333R has a built in Ultra DMA 133 function. This means that it provides speedier HDD throughput boosting overall system performance. Ultra DMA 133 is the newest standard for IDE devices. It enhances existing Ultra DMA 33 technology by increasing both performance and data integrity. This new high-speed interface almost double the Ultra DMA 66 burst data transfer rate to 133 Mbytes/sec. The result is maximum disc performance using the current PCI local bus environment. Another benefit is you can connect four IDE devices in your system through either Ultra DMA 66, Ultra DMA 100 or Ultra DMA 133. You will have more flexibility to expand your computer system.

KX7-333R's built-in HighPoint HPT 372 chipset gives you the capability to support Ultra DMA 133. Ultra DMA 133 is the newest standard for IDE devices. It provides two IDE channels (IDE3, IDE4) that also support Ultra DMA 133 specifications, and it allows for four additional IDE devices in your computer system. It can give you high performance and efficiency data transfer rate through the IDE channels. This also means that your computer, in total, can connect up to eight IDE devices (IDE1 ~ IDE4). This allows for maximum expandability for future hardware demands. This chipset also supports IDE RAID, including RAID 0, RAID 1 and RAID 0+1. This feature enables you to maximize your data storage performance and security.

KX7-333/KX7-333R provides high flexibility to users building AMD Socket A Athlon™ XP, Athlon™ and Duron™ systems. It provides the option of 133MHz/133MHz CPU and memory bus combinations.

The KX7-333/KX7-333R has built-in hardware monitoring functions (refer to *Appendix B* for detailed information) to ensure a safe computing environment.

1-2. Specifications

1. CPU

- Supports AMD Athlon™ XP 1500+ ~ 2200+ or future Socket A processors based on 200 MHz/266 MHz (100 MHz/133 MHz Double Data Rate)
- Supports AMD Athlon™ 700 MHz ~ 1.4 GHz or future Socket A processors based on 200 MHz/266 MHz (100 MHz/133 MHz Double Data Rate)
- Supports AMD Duron™ 600 MHz ~ 1.2 GHz or future Socket A processors based on 200 MHz (100 MHz Double Data Rate)
- Supports 200 MHz Alpha EV6 bus for the AMD Athlon™ XP, Athlon™ and Duron™ processors

2. Chipset (VIA KT333 and VT8233A):

- Supports Ultra DMA 33, Ultra DMA 66, Ultra DMA 100 and Ultra DMA 133 IDE protocol
- Supports Advanced Configuration and Power Management Interface (ACPI)
- Accelerated Graphics Port connector supports AGP 2X (3.3V) and 4X (1.5V) mode (Sideband) device
- Supports 200 MHz/266 MHz/333 MHz (100 MHz/133 MHz/166 MHz Double Data Rate) memory bus settings

3. Ultra DMA 133/RAID (For KX7-333R Only)

- HighPoint HPT 372 IDE controller
- Supports Ultra DMA 133 MB/sec data transfer rate
- Supports RAID0 (Stripping mode for boosting performance) mode
- Supports RAID1 (Mirroring mode for data security) mode
- Supports RAID 0+1 (Stripping and Mirroring) mode

4. Memory (System Memory)

- Four 184-pin DIMM slots support PC 1600, PC 2100 and PC 2700 DDR SDRAM modules
- Supports 6 banks up to 3 GB DRAMs for unbuffered DDR/SDRAM modules. (64, 128, 256, 512 MB and 1 GB DDR SDRAM). For PC 2700 DDR SDRAM modules, it supports 4 banks up to 2 GB DRAMs for unbuffered DDR/SDR modules. (64, 128, 256, 512 MB and 1 GB DDR SDRAM).
- Supports 8 banks up to 3.5 GB DRAMs for registered DDR/SDRAM modules. (64, 128, 256, 512 MB and 1 GB DDR SDRAM). For PC 2700 DDR SDRAM modules, it supports 6 banks up to 3 GB DRAMs for registered DDR/SDRAM modules. (64, 128, 256, 512 MB and 1 GB DDR SDRAM).

5. System BIOS

- SOFT MENU™ III technology, can easily set the processor parameters
- Award PnP (Plug and Play) BIOS supports APM and DMI (Desktop Management Interface)
- Supports ACPI (Advanced Configuration Power Interface)
- Write-Protect Anti-Virus function by AWARD BIOS

6. Multi I/O Functions

- Two channels of Bus Master IDE ports supporting up to four Ultra DMA 33/66/100/133 devices (**KX7-333 Only**). And two channels (IDE3 & IDE4) of Bus Master IDE ports supporting up to four Ultra DMA 33/66/100/133 specifications HDD devices (**KX7-333R Only**)
- One floppy port connector (up to 2.88MB)
- One PS/2 keyboard and PS/2 mouse connectors

- Two USB connectors
- Two serial ports connectors
- One parallel port connector (Standard/EPP/ECP)

7. Miscellaneous

- ATX form factor
 - One AGP slot, six PCI slots
 - Built-in Wake on LAN header
 - Built-in IrDA TX/RX header
 - Built-in Wake On Ring header
 - One USB header for two extra USB channels
 - Hardware monitoring : Included fan speed, voltages, CPU and system environment temperature
 - Board size: 305 * 245mm
- ✱ Supports Wake On LAN, Modem, but your ATX power supply 5V standby power must be able to provide at least a 720mA current capacity. Otherwise, the functions may not work normally.
- ✱ PCI slot 5 shares IRQ signals with the HPT 372 IDE controller (supports Ultra DMA 133). The driver for HPT 372 IDE controller supports IRQ sharing with other PCI devices. But if you install a PCI card that doesn't allow IRQ sharing with other devices into PCI slot 5, you may encounter some problems. Furthermore, if your Operating System doesn't allow peripheral devices to share IRQ signals with each other, such as Windows® NT for example, you can't install a PCI card into PCI slot 5. (KX7-333R Only)
- ✱ HPT 372 IDE controller is designed to support high-speed and high performance mass storage devices. Thus we suggest that you don't connect non-disk devices that use ATA/ATAPI interfaces, such as CD-ROM to HPT 372 IDE connector (IDE3 & IDE4). (KX7-333R Only)
- ✱ This motherboard supports the standard bus speeds of 66 MHz/100 MHz/133 MHz that are used by specific PCI, processor and chipset specifications. Exceeding these standard bus speeds is not guaranteed due to the specific component specifications.
- ✱ Specifications and information contained in this manual are subject to change without notice.

Note

All brand names and trademarks are the property of their respective owners.

1-3. Item Checklist

Check that your package is complete. If you discover any damaged or missing items, please contact your retailer or dealer.

- One ABIT KX7-333 or one KX7-333R motherboard
- One 80-wire/40-pin ribbon cable for master and slave Ultra DMA 133, Ultra DMA 100, Ultra DMA 66 or Ultra DMA 33 IDE devices (**KX7-333 Only**)
- Two 80-wire/40-pin ribbon cable for master and slave Ultra DMA 133, Ultra DMA 100, Ultra DMA 66 or Ultra DMA 33 IDE devices (**KX7-333R Only**)

Chapter 2. Installing the Motherboard

This KX7-333/KX7-333R motherboard not only provides all standard equipment for classic personal computers, but also provides great flexibility for meeting future upgrade demands. This chapter will introduce step by step all of the standard equipment and will also present, as completely as possible, future upgrade capabilities. This motherboard is able to supports all AMD Socket A Athlon™ XP, Athlon™ and Duron™ processors now on the market. (For details, see specifications in Chapter 1.)

This chapter is organized according the following features:

1. Installation of the AMD Socket A Athlon™ XP, Athlon™ and Duron™ CPU
2. Installing the Motherboard to the Chassis
3. Installing System Memory
4. Connectors, Headers and Switches



Before Proceeding with the Installation



Before you install or unplug any connectors or add-on cards, please remember to turn the ATX power supply switch off (fully turn the +5V standby power off), or take the power cord off. Otherwise, you may cause the motherboard components or add-on cards to malfunction or be damaged.



User Friendly Instructions

Please read our instructions carefully and follow them step-by-step. Our objective is to enable the novice computer user to perform the installation by himself. We have attempted to write this document in a very clear, concise and descriptive manner to help overcome any obstacles you may face during installation.

Diagram and Photos

This chapter contains many color drawings, diagrams and photos, we strongly recommend you read this chapter use the PDF file that is stored on the CD-Title. Color improves the clarity and quality of the diagrams. For the downloadable edition, as files larger than 3 MB are difficult to download, we will cut the graphics and photo resolution to reduce the manual file size. In such this case, if your manual is downloaded from our WEB site and not from a CD-ROM, enlarging graphics or photos will distort the image.

2-1. Installation of the AMD Athlon™ XP, Athlon™ and Duron™ CPU

Note

- Installing a heatsink and cooling fan is necessary for heat to dissipate from your processor. Failing to install these items may result in overheating and processor damage.
- The AMD Socket A processor will produce a lot of heat while operating, so you need to use a large heat sink that is especially designed for the AMD socket A processor. Otherwise, it may result in overheating and processor damage.
- If your processor fan and its power cable are not installed properly, never plug the ATX power cable into the motherboard. This can prevent possible processor damage.
- Please refer to your processor installation manual or other documentation with your processor for detailed installation instructions.

The AMD Socket A Athlon™ XP, Athlon™ and Duron™ processor installation is easy, like Socket 7 Pentium® processors before. Because it uses the “**Socket A**” ZIF (Zero Insertion Force) socket, you can easily fix the processor firmly into position. Figure 2-1 shows you what the socket A looks like, and how to open the lever. The socket A has more pins than the socket 7. Therefore, a Pentium® level processor cannot be inserted into a socket A.

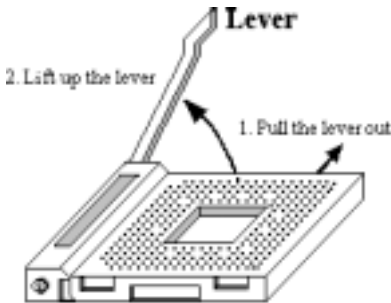

Figure 2-1. Socket A and open its lever

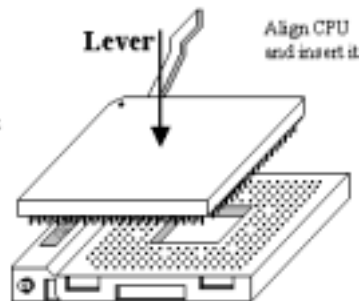

Figure 2-2. Install the CPU into socket A

When you raise the lever, you have to loosen the socket lock. Please raise the lever to the end, and prepare to insert the processor. Next, you need to align the processor pin 1 to the socket pin 1. If you put it in the wrong direction, you will not be able to insert the processor easily, and processor pins will not fully go into the socket. If this is the case, please change the direction, until it easily and fully inserts into the socket A. See Figure 2-2. At the same time check the processor temperature detection thermistor height (if your motherboard has this component), then you can slowly insert the processor into the Socket A. Finally, you need to check that the processor edge and the Socket A edge is parallel. It should be parallel and not tilted.

When you finish the above, push the lever down to its original position, you should feel the lever lock the socket A. You have then finished the processor installation.

Heatsink Installation Hints

Because the processor will produce a lot of heat while operating, we suggest you use a heatsink approved by AMD to be safe and to keep the processor temperature within normal operation temperatures. The heatsink will be large and heavy, so the fixing plate has a strong tension. When you install the heatsink onto the processor and its socket, you have to very carefully fix the fixing plate to the processor socket hook on both sides. If you do not pay attention to this, you may make the fixing plate scratch the PCB surface and cause circuit damage, break socket hooks or damage the die on top of processor.



Please follow the sequence mentioned below, **Do Not** inverse the sequence. Otherwise, you may have a situation like the photo on the left. Because of the design of the CPU socket, the left side hooks are not as strong as the right side hooks. If you follow our suggestions you will prevent your processor and socket from damage.

Note

Considering the chassis structure problem, please always take off the motherboard from chassis, before adding or removing a heatsink kit.

The proper procedure to install the heatsink kit:



First, install the processor into the processor socket.



Insert the heatsink left side fix plate into the processor socket left side fix hooks. Make sure the fit is very tight. Check the photo on the left.



Insert a flat screwdriver into the middle slot of the right side fix plate and push down. Then you can push the fix plate over the socket hooks on the right side. Check the photo on the left.



Check the photo on the left. You have finished the heatsink installation.

Now hold the whole heatsink and slightly shake it, make sure the bottom right side of the heatsink does not contact the right side of the Socket (see bottom picture). Otherwise, the processor die does not have proper contact with the heatsink. This situation may cause processor damage.

Remember to install the heatsink fan power cable to the CPU fan header on the motherboard.



Now you can reinstall the motherboard back into the chassis.

When all above procedures done, you can connect the ATX power cable to the motherboard.

If you have different types of heatsink kit, please refer to the manual that came with the heatsink kit. The left photo shows another type of heatsink fix plate design. The install sequences are still the same, from right side to left side. Just remember that.

We strongly recommend you to buy a heatsink with three holes in the fix plate. This will provide the best stability and won't cause the Socket fix hooks to be broken or damaged.



The left photo shows the bottom right side of the heatsink in contact with the right side of the Socket. In this situation, the processor die does not properly contact the heatsink. If you start the computer at this moment, it will immediately cause the processor damage. Always check this place when you finish the heatsink installation.

2-2. Installing the Motherboard to the Chassis

After you install the processor to the motherboard, you can start to fix the motherboard into the chassis. Most computer chassis will have a base on which there will be many mounting holes that allows the motherboard to be securely attached and at the same time, prevents short circuits. There are two ways to attach the motherboard to the base of chassis:

- With studs
- With spacers

Please refer to figure 2-3, which shows the studs and spacers. There may be several types, but all look like the figures below:



Figure 2-3. The outline of stud and spacer

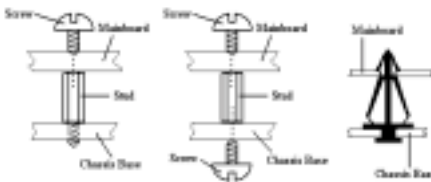

Figure 2-4. The way we fixed the motherboard using studs or spacers.

In principle, the best way to attach the motherboard is with studs. Only if you are unable to do this should you attach the board with spacers. Take a careful look at the motherboard and you will see many mounting holes on it. Line these holes up with the mounting holes on the base. If the holes line up and there are screw holes this means you can attach the motherboard with studs. If the holes line up and there are only slots, this means you can only attach the motherboard with spacers. Take the tip of the spacers and insert them into the slots. After doing this to all the slots, you can slide the motherboard into position aligned with the slots. After the motherboard has been positioned, check to make sure everything is OK before putting the casing back on.

Figure 2-4 shows you the way to affix the

Note

If the motherboard has mounting holes, but they don't line up with the holes on the base and there are no slots to attach the spacers, don't worry, you can still attach the spacers to the mounting holes. Just cut the bottom portion of spacers (the spacer they may be a little hard to cut, so be careful with your hands). In this way you can still attach the motherboard to the base without worrying about short circuits. Sometimes you may need to use the plastic springs to isolate the screw from the motherboard PCB surface, because the circuit wire may be near by the hole. Be careful, don't let the screw contact any the printed circuit wire or parts on the PCB that are near the fixing hole, otherwise it may damage the board or cause board malfunctioning.

2-3. Installing System Memory

This motherboard provides four 184-pin DDR DIMM sites for memory expansion. The DDR SDRAM DIMM sockets support 8 M x 64 (64 MB), 16M x 64 (128 MB), 32 M x 64 (256 MB), 64 M x 64 (512 MB) and 128 M x 64 (1024 MB) or double density DDR SDRAM DIMM modules. Minimum memory is 64 MB and the maximum memory is 3 GB (**Unbuffered, PC 1600 and PC 2100**) / 2GB (**Unbuffered, PC 2700**) or 3.5 GB (**Registered, PC 1600 and PC 2100**) / 3 GB (**Registered, PC 2700**) DDR SDRAM. There are four memory module sockets on the system board (for a total of eight banks). In order to create a memory array, following rules must be followed.

- For those modules, we suggest that you be populate DIMM1 to DIMM4 in order.
- Supports single and double density DDR DIMMS.

Table 2-1. Valid Memory Configurations

Bank	Memory Module	Total Memory
Bank 0, 1 (DDR DIMM1)	64 MB, 128 MB, 256 MB, 512 MB, 1024 MB	64 MB ~ 1 GB
Bank 2, 3 (DDR DIMM2)	64 MB, 128 MB, 256 MB, 512 MB, 1024 MB	64 MB ~ 1 GB
Bank 4, 5 (DDR DIMM3)	64 MB, 128 MB, 256 MB, 512 MB, 1024 MB	64 MB ~ 1 GB
Bank 6, 7 (DDR DIMM4)	64 MB, 128 MB, 256 MB, 512 MB, 1024 MB	64 MB ~ 1 GB
Total System Memory for Unbuffered DDR DIMM (PC 1600/PC 2100)		64 MB ~ 3 GB
Total System Memory for Registered DDR DIMM (PC 1600/PC 2100)		64 MB ~ 3.5 GB
Total System Memory for Unbuffered DDR DIMM (PC 2700)		64 MB ~ 2 GB
Total System Memory for Registered DDR DIMM (PC 2700)		64 MB ~ 3 GB



Figure 2-5. PC1600/PC2100/PC2700 DDR Module and Component Mark

Generally, installing DDR SDRAM modules to your motherboard is an easy thing to do. You can refer to Figure 2-5 to see what a 184-pin PC 1600, PC 2100 and PC 2700 DDR SDRAM module looks like.

Unlike installing SIMMs, DIMMs may be “snapped” directly into the socket. Note: Certain

DDR DIMM sockets have minor physical differences. If your module doesn't seem to fit, please do not force it into the socket as you may damaged your memory module or DDR DIMM socket.

The following procedure will show you how to install a DDR DIMM module into a DDR DIMM socket.

- Step 1.** Before you install the memory module, please place the computer power switch in the *off* position and disconnect the AC power cord from your computer.
- Step 2.** Remove the computer's chassis cover.
- Step 3.** Before touching any electronic components, make sure you first touch an unpainted, grounded metal object to discharge any static electricity stored on your clothing or body.
- Step 4.** Locate your computer's 184-pin memory expansion DDR DIMM socket.

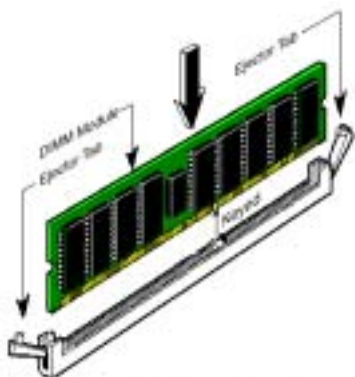

Figure 2-6. DDR DIMM module installation

- Step 5.** Insert the DDR DIMM module into the expansion socket as shown in the illustration. Note how the module is keyed to the socket. You can refer to Figure 2-6 for the details. ***This insures the DDR DIMM module will be plugged into the socket in one way only.*** Firmly press the DDR DIMM module into DDR DIMM socket, making certain the module is completely seated in the DDR DIMM socket.
- Step 6.** Once the DDR DIMM module has been installed, the installation is complete and the computer's cover can be replaced. Or you can continue to install other devices and add-on cards that are mentioned in the following section.

Note

When you install a DDR DIMM module fully into the DDR DIMM socket, the eject tab should be locked into the DDR DIMM module very firmly and fit into its indentation on the both sides.

It is difficult to differentiate between the PC 1600, PC 2100 and PC 2700 DDR SDRAM modules from the exterior. The only way you can identify them is to look at the sticker on the DDR SDRAM module. The sticker will tell you which kind of structure module the DDR SDRAM is.

2-4. Connectors, Headers and Switches

Inside the case of any computer several cables and plugs have to be connected. These cables and plugs are usually connected one-by-one to connectors located on the motherboard. You need to carefully pay attention to any connection orientation the cables may have and, if any, notice the position of the first pin of the connector. In the explanations that follow, we will describe the significance of the first pin.

We will show you all of the connectors, headers and switches here, and tell you how to connect them. Please pay attention and read the entire section for necessary information before attempting to finish all of the hardware installation inside the computer chassis.

Figure 2-7 shows you all of the connectors and headers that we'll discuss in the next section, you can use this diagram to visually locate each connector and header we describe.

Note

This components diagram will be slightly different because there are a number of models. We'll use the KX7-333R motherboard as standard; all descriptions of connector and header will be based on the KX7-333R motherboard.

All connectors, headers and switches mentioned here, will depend on your system configuration. Some

features you may (or may not) have and need to connect or configure depending on the peripheral. If your system doesn't have such add-on cards or switches you can ignore some special feature connectors.

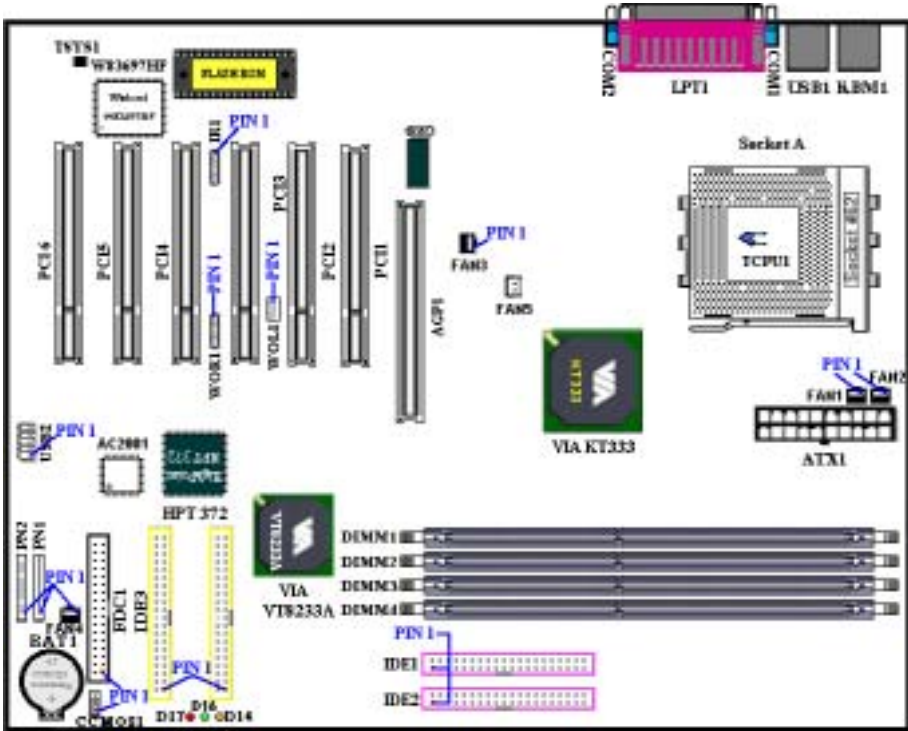
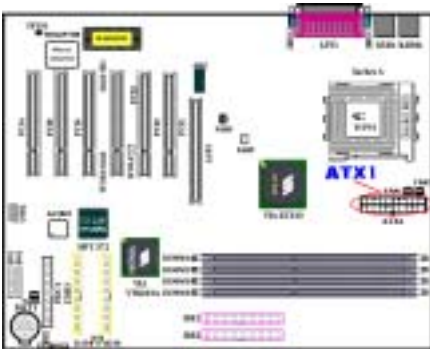

Figure 2-7. All connectors and headers for the KX7-333R

First, Let's see the headers that KX7-333R uses, and what their functions are. We will show you all the connectors and headers.

(1). ATX1: ATX Power Input Connector



Attach the connector from the power supply to the ATX1 connector here. Remember you have to push the connector from the ATX power supply firmly to the end with the ATX1 connector, insuring that you have a good connection.

Note: Watch the pin position and the orientation.

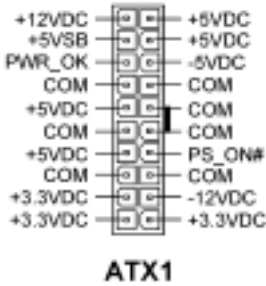

Caution

If the power supply connectors are not properly attached to the ATX power supply, the power supply or add-on cards may be damaged.

One end of AC power cord connects to ATX power supply, and the other end (AC plug) will plug into the wall outlet. Be aware that when facing the wall outlet, the round hole is in the middle. The right side slot is called ground wire slot. It has a longer slot length than the left side slot. The left side slot is called the live wire slot. You can use an electroscop to detect its polarity or you can use a voltage meter to measure the voltage of both slot sides. If you insert an electroscop into the live wire slot, the electroscop will light up. Using a voltage meter, you will find that the live wire slot will register a higher voltage.

If you reverse the polarity of AC plug, it may affect the life of computer equipment, or cause an electric shock when you touch the computer chassis. We suggest that you plug the computer AC plug to a three-hole wall outlet for better safety and to avoid electric shock.

(2). FAN1, FAN2, FAN3, FAN4 & FAN5 header



Attach the connector from the processor fan to the header named FAN1 or FAN2 (These two fan headers have a sense signal that can detect fan rotation speeds) and connector from the front chassis fan to the header FAN4. Attach the connector from the power fan or back chassis fan to FAN3 header and attach the connector from northbridge fan to the header named FAN5.

You must attach the CPU fan to the processor, or your processor will work abnormally or may be damaged by overheating. To prevent the computer chassis internal temperature from getting too high, also connect the chassis fan.

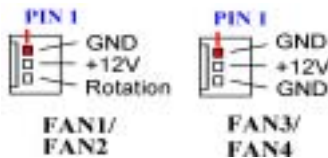

Note: Watch the pin position and the orientation

(3). IR1: IR Header (Infrared)

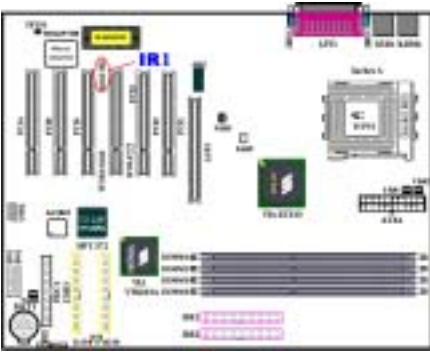

There is a specific orientation for pins 1 through 5, attach the connector from the IR KIT or IR device to the IR1 header. This motherboard supports standard IR transfer rates.

- 1 ■ — +5V
 - 2 — No Pin
 - 3 — IRRX
 - 4 — GND
 - 5 — IRTX
- IR1**

Note: Watch the pin position and the orientation

(4). WOR1: Wake On Ring Header

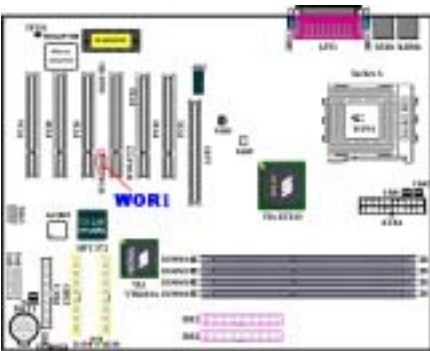

If you have an internal modem adapter that supports this feature, then you can connect the specific cable from the internal modem adapter to this header. This feature lets you wake up your computer via remote control through the modem.

- 1 ■ — +5VSB
 - 2 — No Pin
 - 3 — Sense Input
 - 4 — GND
 - 5 — No Conn.
- WOR1**

Note: Watch the pin position and the orientation

(5). WOL1: Wake on LAN Header

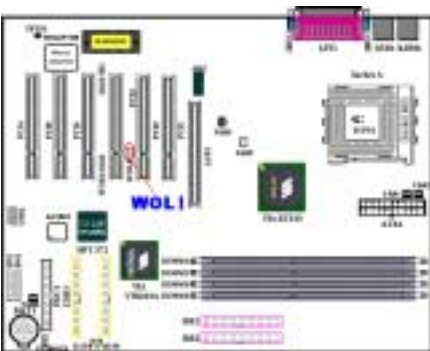

If you have a network adapter that supports this feature, then you can connect the specific cable from the network adapter to this header. This feature lets you wake up your computer via remote control through a local area network. You may need a specific utility to control the wake up event, like using the PCnet Magic Packet utility or other similar utilities.

There are three types of WOL, “Remote Wake-Up high (RWU-high)”, “Remote Wake-Up low (RWU-low)”, and “Power Management Event (PME)”. This motherboard supports the type of “Remote Wake-Up low (RWU-low)” only.

Note: Watch the pin position and the orientation

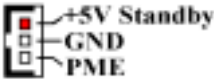

WOL1

(6). TCPU1 & TSYS1: Temperature Thermistor

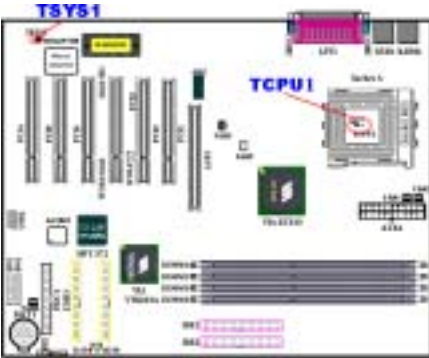

The TCPU1 is used to detect the CPU temperature. The TSYS1 is used to detect the system environment temperature. You can see the readings in the BIOS or in the hardware monitoring application main screen.

(7). USB2 Header: Additional USB Plugs Header

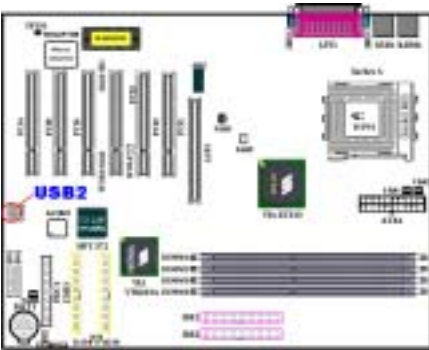

This header is for connecting the additional USB port plugs. You can use the special USB port expansion cable. It provides four additional USB plugs. These USB plugs can be fixed on the back panel.

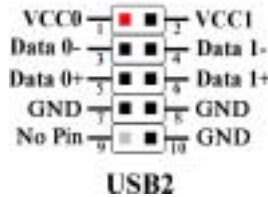

(8). CCMOS1: CMOS Discharge Jumper

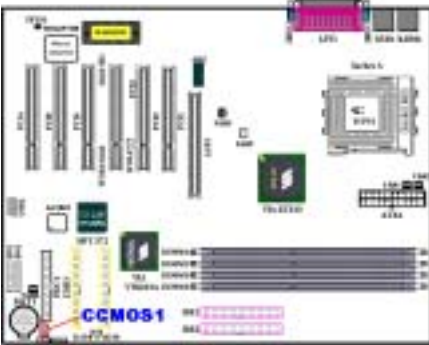

Jumper CCMOS1 discharge CMOS memory. When you install the motherboard, make sure this jumper is set for normal operation (pin 1 and 2 shorted). See Figure 2-8.

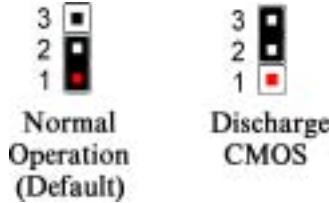

Note

Before you clear the CMOS, you have to first turn the power off (including the +5V standby power). Otherwise, your system may work abnormally.

After updating your BIOS and before boot up, please clear the CMOS first. Then put the jumper to its default position. After that, you can reboot your system and ensure that your system is working fine.

(9). PN1 and PN2 Headers

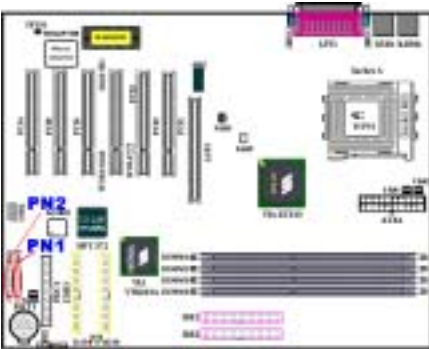

PN1 and PN2 are for switches and indicators for the chassis's front panel, there are several functions that come from these two headers. You have to watch the pin position and the orientation, or you may cause system malfunctions. Figure 2-9 shows you the PN1 and PN2 functions of the pins.

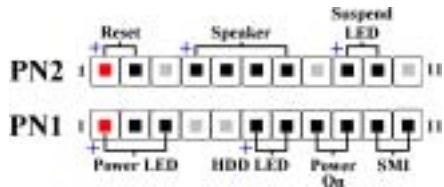

PN1 (Pin 1-2-3): Power LED Headers

There is a specific orientation for pins 1 through 3. Insert the three-threaded power LED cable to pins 1~3. Check to make sure the correct pins go to the correct connectors on the motherboard. If you install them in the wrong direction, the power LED light will not illuminate correctly.

Note: Watch the power LED pin position and orientation.

PN1 (Pin 6-7): HDD LED Header

Attach the cable from the case's front panel HDD LED to this header. If you install it in the wrong direction, the LED light will not illuminate correctly.

Note: Watch the HDD LED pin position and the orientation.

PN1 (Pin 8-9): Power on Switch Header

Attach the cable from the case's front panel power switch to this header.

PN1 (Pin 10-11): Hardware Suspend Switch (SMI Switch) Header

Attach the cable from the case's front panel suspend switch (if there is one) to this header. Use this switch to enable/disable the power management function by hardware.

PN2 (Pin 1-2): Hardware Reset Switch Header

Attach the cable from the case's front panel Reset switch to this header. Press and hold the reset button for at least one second to reset the system.

PN2 (Pin 4-5-6-7): Speaker Header

Attach the cable from the system speaker to this header.

PN2 (Pin 9-10): Suspend LED Header

Insert the two-threaded suspend LED cable into pin 9 and pin 10. If you install it in the wrong direction, the LED light will not illuminate correctly.

Note: Watch the Suspend LED pin position and the orientation.

For the PN1 and PN2 pin's count-name list, please refer to table 2-2.

Table 2-2. PN1 and PN2 pin count name list

PIN Name		Significance of signal	PIN Name		Significance of signal
PN1	PIN 1	+5VDC	PN2	PIN 1	Ground
	PIN 2	No connection		PIN 2	Reset input
	PIN 3	Ground		PIN 3	No connection
	PIN 4	No connection		PIN 4	+5VDC
	PIN 5	No connection		PIN 5	Ground
	PIN 6	LED power		PIN 6	Ground
	PIN 7	HDD active		PIN 7	Speaker data
	PIN 8	Ground		PIN 8	No connection
	PIN 9	Power On/Off signal		PIN 9	LED power
	PIN 10	Ground		PIN 10	Suspend active
	PIN 11	Suspend signal		PIN 11	No connection

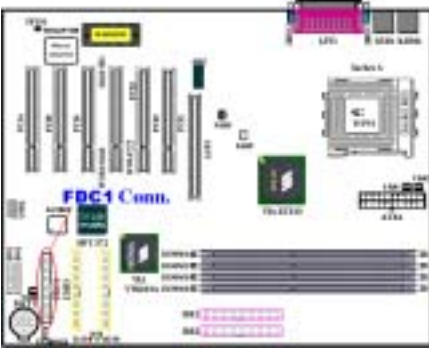
(10). FDC1 Connector

This 34-pin connector is called the “*floppy disk drive connector*”. You can connect a 360K, 5.25”, 1.2M, 5.25”, 720K, 3.5”, 1.44M, 3.5” or 2.88M, 3.5” floppy disk drive.

A floppy disk drive ribbon cable has 34 wires and two connectors to provide the connection of two floppy disk drives. After connecting the single end to the FDD1, connect the two connectors on the other end to the floppy disk drives. In general, people only install one floppy disk drive on their computer system.

Note

A red mark on a wire typically designates the location of pin 1. You need to align the wire pin 1 to the FDC1 connector pin 1, then insert the wire connector into the FDC1 connector.

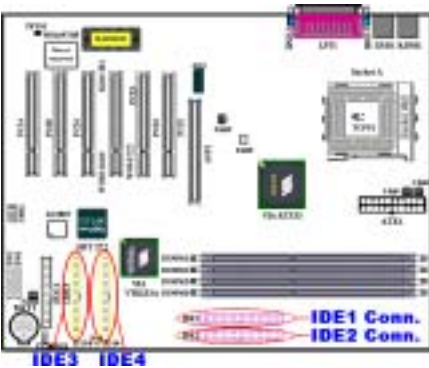
(11). IDE1, IDE2, IDE3 and IDE4 Connectors

This motherboard provides two IDE ports (IDE1 & IDE2) to connect up to four IDE devices in Ultra DMA 133 mode by Ultra DMA 66 ribbon cables. Each cable has 40-pin 80-conductor and three connectors, providing two hard drive connections with the motherboard. Connect the single end (blue connector) at the longer length of ribbon cable to the IDE port on motherboard, and the other two ends (gray and black connector) at the shorter length of the ribbon cable to the connectors on hard drives.

KX7-333R’s built-in HighPoint HPT 372 chipset gives you the capability to support Ultra DMA 133. It provides two IDE channels (IDE3 & IDE4) that also support Ultra DMA 133 specifications, and it allows for four additional IDE devices in your

computer system. Especially, if you want to connect two or four HDDs to get RAID functions, it is very convenient for you to install the HDDs to IDE3 and IDE4. See the Chapter 4 for detailed information about RAID settings.

If you want to connect two hard drives together through one IDE channel, you must configure the second drive to Slave mode after the first Master drive. Please refer to the HDD documentation for jumper settings. The first drive connected to IDE1 is usually referred to as “**Primary Master**”, and the second drive as “**Primary Slave**”. The first drive connected to IDE2 is referred to as “**Secondary Master**” and the second drive as “**Secondary Slave**”.

Keep away from connecting one legacy slow speed device, like CD-ROM, together with another hard drive on the same IDE channel; this will decrease your integral system performance.

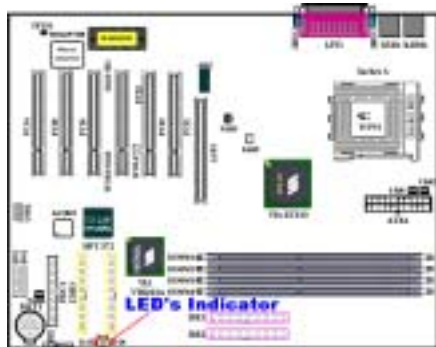

Figure 2-8. Ultra DMA 66 Ribbon Cable Outline

Note

- The Master or Slave status of the hard disk drive is set on the hard disk itself. Please refer to the hard disk drive user’s manual.
- To connect Ultra DMA 100 & Ultra DMA 133 devices on IDE1 to IDE4, an Ultra DMA 66 cable is required.
- A red mark on a wire typically designates the location of pin 1. You need to align the wire pin 1 to the IDE connector pin 1, before inserting the wire connector into the IDE connector.

(12). D14, D16 and D17 LEDs Indicator: Status LEDs indicators



There are three indicators on the motherboard.

D14 is a standby power indicator. When the +5VSB supplies power to the motherboard, this LED indicator will light up.

D16 is a power on indicator. When the power button is pressed, this LED indicator will light up.

D17 is a reset indicator. When you press the reset button, this LED indicator will light up. If you release the reset button, this indicator will turn off.

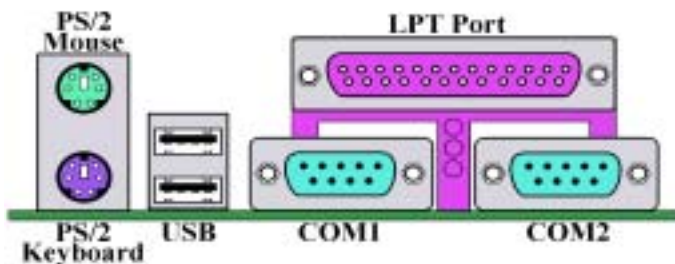

Figure 2-9. KX7-333/KX7-333R back panel connectors

Figure 2-9 shows the KX7-333/KX7-333R back panel connectors, these connectors are for connection to outside devices to the motherboard. We will describe which devices will attach to these connectors below.

(13). PS/2 Keyboard Connector

Attach a PS/2 keyboard connector to this 6-pin Din-connector. If you use an AT keyboard, you can go to a computer store to purchase an AT to ATX converter adapter, then you can connect your AT keyboard to this connector. We suggest you use a PS/2 keyboard for best compatibility.

(14). PS/2 Mouse Connector

Attach a PS/2 mouse to this 6-pin Din-connector.

(15). USB Port Connectors

This motherboard provides two USB ports. Attach the USB connector from the individual device to these connectors.

You can attach USB devices such as a, scanner, digital speakers, monitor, mouse, keyboard, hub, digital camera, joystick etc. to one of each USB connector. You must make sure your operating system supports this feature and you may need to install an additional driver for individual devices. In Please refer to your device user's manual for detailed information.



External FAX/Modem



Digital Tablet



Digital Camera

(16). Serial Port COM1 & COM2 Port Connectors

This motherboard provides two COM ports, you can connect an external modem, mouse or other devices that support this communication protocol to these connectors.

You can decide which external devices you want to connect to COM1 and COM2. Each COM port can only have one device connected at a time.

(17). Parallel Port Connector

This parallel port is also called an "LPT" port, because it usually connects to the printer. You can connect other devices that support this communication protocol, like an EPP/ECP scanner, etc.



Laser Printer



Inkjet Printer



EPP/ECP Scanner

Note

This chapter contains many color drawing diagram and photos, we strongly recommend you to read this chapter use the PDF file we gave you that store in the CD-Title. It will provide you the better look and clearly color identify.



Chapter 3. Introducing the BIOS

The BIOS is a program located on a Flash Memory chip on the motherboard. This program will not be lost when you turn the computer off. This program is also referred to as the boot program. It is the only channel the hardware circuit has to communicate with the operating system. Its main function is to manage the setup of the motherboard and interface card parameters, including simple parameters such as time, date, hard disk drive, as well as more complex parameters such as hardware synchronization, device operating mode, **SOFT MENU™ III** features and setup of CPU speed. The computer will operate normally, or will operate at its best, only if all of these parameters are correctly configured through the BIOS.



Don't change the parameters inside the BIOS unless you fully understand the meanings and consequences

The parameters inside the BIOS are used to setup the hardware synchronization or the device-operating mode. If the parameters are not correct, they will produce errors, the computer will crash, and sometimes you will even not be able to boot the computer after it has crashed. We recommend that you do not change the parameters inside the BIOS unless you are very familiar with them. If you are not able to boot your computer anymore, please refer to the section “**CCMOS1 Discharge Jump[®]**” in Chapter 2 to see how to discharge the CMOS date.

When you start the computer, the BIOS program controls it. The BIOS first operates an auto-diagnostic test called POST (Power On Self Test) for all of the necessary hardware. It then configures the parameters of the hardware synchronization, and detects all of the hardware. Only when these tasks are completed does it give up control of the computer to the program to the next level, which is the operating system (OS). Since the BIOS is the only channel for hardware and software to communicate, it is the key factor for system stability, and in insuring that your system performs at its best. After the BIOS has achieved the auto-diagnostic and auto-detection operations, it will display the following message:

PRESS DEL TO ENTER SETUP

The message will be displayed for three to five seconds, if you press the **Del** key, you will access the BIOS Setup menu. At that moment, the BIOS will display the following message:



Figure 3-1. CMOS Setup Utility

In the BIOS Setup main menu of Figure 3-1, you can see several options. We will explain these options step by step in the following pages of this chapter, but let us first see a short description of the function keys you may use here:

- Press **Esc** to quit the BIOS Setup.
- Press **↑ ↓ ← →** (up, down, left, right) to choose, in the main menu, the option you want to confirm or to modify.
- Press **F10** when you have completed the setup of BIOS parameters to save these parameters and to exit the BIOS Setup menu.
- Press **Page Up/Page Down** or **+/-** keys when you want to modify the BIOS parameters for the active option.

Note

Parts of the screenshot may not same as you see on your screen, because the BIOS version may change periodically. However, most of the functions covered in this manual will work. We suggest that you go to our WEB site often to see if there are new manual releases. Then you can check the newly updated BIOS items.

Computer Knowledge: CMOS Data

Maybe you have heard somebody saying that his or her CMOS DATA was lost. What is the CMOS? Is it important? The CMOS is the memory used to store the BIOS parameters that you have configured. This memory is passive. You can read its data, and you can also store data in it. But this memory has to be powered by a battery, in order to avoid any loss of its data when the computer is turned off. Since you may have to change the CMOS battery when it is out of power and if doing so, you will loose all CMOS data, therefore, we recommend that you write down all the parameters of your hardware, or to put a label with these parameters on your hard disk.

3-1. CPU Setup [SOFT MENU™ III]

The CPU can be setup through a programmable switch (**CPU SOFT MENU™ III**), that replaces the traditional manual hardware configuration. This feature allows the user to more easily complete the installation procedures. You can install the CPU without configuring any jumpers or switches. The CPU must be setup according its specifications. In the first option, you can press <Enter> at any time to display all the items that can be chosen for that option.

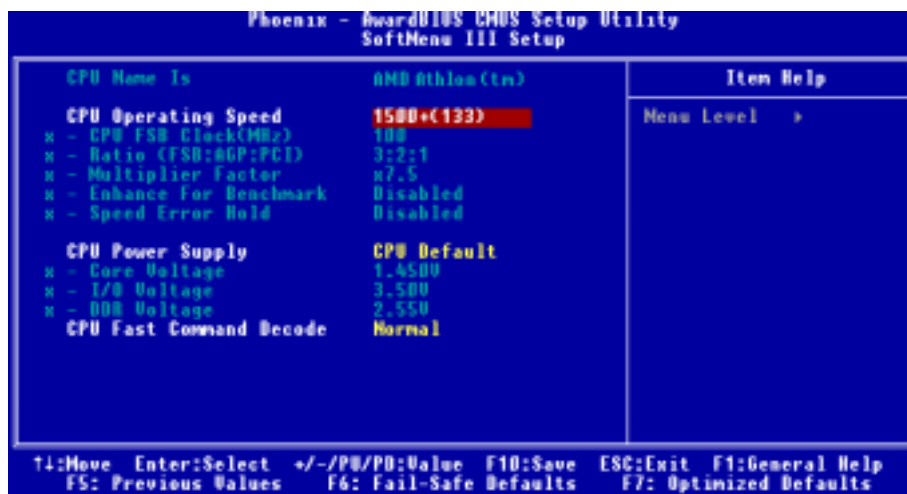

Figure 3-2. CPU SOFT MENU™ III

CPU Name Is:

- AMD Athlon (tm) XP
- AMD Athlon (tm)
- AMD Duron (tm)

CPU Operating Speed:

This option sets the CPU speed. In this field, the CPU speed is indicated like this: $\text{CPU speed} = \text{External clock} * \text{Multiplier factor}$, select the CPU speed according the type and the speed of your CPU. For AMD Athlon™ XP, Athlon™ and Duron™ processors, you can choose the following settings. (This example is for AMD Athlon™ XP processor):

- User Define ➤ 1500+ (133) ➤ 1600+ (133) ➤ 1700+ (133) ➤ 1800+ (133) ➤ 1900+ (133)
- >=2000+ (133)

Note

The display of this item might be different when you installed the different type of processors. We just show you an example here.

User defined external clock and multiplier factor:

► **User Defined**



The wrong settings of the multiplier and external clock in certain circumstances may cause CPU damage

The wrong settings of the multiplier and external clock in certain circumstances may cause CPU damage. Setting the working frequency higher than the specifications of PCI or of processor may cause abnormal memory module functioning, system hangs, hard disk drive data loss, abnormal functioning of the VGA card, or abnormal functioning with other add-on cards. Using non-specification settings for your CPU is not the intention of this explanation, for which should be used for engineering testing only, not for normal applications.

If you use non-specification settings for normal operation, your system may not be stable, and may effect system reliability. Also, we do not guarantee the stability and compatibility for settings that are not within specification, and any damage of any elements on the motherboard or peripherals, is not our responsibility.

► **CPU FSB Clock (MHz):**

You can increase the CPU FSB clock speed here. This means that you can independently increase the CPU FSB clock speed. The DEC (decimal) numbers from 100 to 200 are available, with the default setting at 100. You can change this setting to increase CPU FSB clock speed. CPU FSB speed above the standard bus speed is supported, but not guaranteed due to the CPU specs.

► **Ratio (FSB:AGP:PCI):**

Three options are available: 3:2:1 → 4:2:1 → 5:2:1. This item lets you set the processor **Front Side Bus**, AGP and PCI clock. It correlates with the processor FSB clock you set. Many of options are available, you can choose the divider ratio you want. If the setting is 3:2:1. In this case, the AGP clock will be the processor FSB clock divided by 3 and times 2. The PCI clock will be the processor FSB clock divided by 3 and times 1.

Note: According your processor FSB frequency, the default values will change also.

► **Multiplier Factor:**

Three are several settings, shown as below:

►x5 ►x5.5 ►x6 ►x6.5 ►x7 ►x7.5 ►x8 ►x8.5 ►x9
 ►x9.5 ►x10 ►x10.5 ►x11 ►x11.5 ►x12 ►x12.5/13 ►over x13

► **Enhance For Benchmark:**

Two options are available: Disabled → Enabled. The default setting is *Disabled*. This item can improving your processor and system performance.

► **Speed Error Hold:**

Two options are available: Disabled → Enabled. The default setting is *Disabled*. If you change the setting to *Enabled* when the CPU speed setting is wrong, the system will hold.

Normally, we do not recommend that you use the “**User Define**” option to setup CPU speed and PCI clock. This option is for setup of future CPUs whose specifications are still unknown. The specifications of all present CPUs are included in the default settings. Unless you are very familiar with all CPU parameters, it is very easy to make mistakes when you define the external clock and the multiplier factor by yourself.

Solution in case of booting problem due to invalid clock setup:

Normally, if the CPU clock setup is wrong, you will not be able to boot. In this case, turn the system off then on again. The CPU will automatically use its standard parameters to boot. You can then enter the BIOS Setup again and set up the CPU clock. If you can't enter the BIOS setup, you must try turning the system on a few times (3~4 times) or press "INSERT" key when turning on and the system will automatically use its standard parameters to boot. You can then enter BIOS SETUP again and set up the new parameters.

When you change your CPU:

This motherboard has been designed in such a way that you can turn the system on after having inserted a CPU in the socket without having to configure any jumpers or DIP switches. But if you change your CPU, normally you just have to turn off the power supply (mechanical off), change the CPU and then, set up the CPU parameters through **SOFT MENU™ III**. However, if the new CPU is slower than the old one (and is same brand and type), we offer you two methods to successfully complete the CPU change operation.

Method 1: Setup up the CPU for the lowest speed for its brand. Turn the power supply off (mechanical off) and change the CPU. Then turn the system on again, and set up the CPU parameters through **SOFT MENU™ III**.

Method 2: Since you have to open the computer case when you change the CPU, it could be a good idea to use the CCMOS jumper to erase the parameters of the original CPU and to enter BIOS Setup to set up CPU parameters again.

Attention

After setting up the parameters and leaving the BIOS SETUP, and having verified that the system can be booted, do not press the Reset button or turn off the power supply. Otherwise the BIOS will not read correctly, the parameters will fail and you must enter **SOFT MENU™ III** again to set up the parameters all over again.

CPU Power Supply:

This option allows you to switch between Default and User Define voltages.

- **CPU Default:** The system will detect the CPU type and select the proper voltage automatically. When it is enabled, the option "**Vcore Voltage**" will show the current voltage setting that is defined by the CPU and this will not be changeable. We recommend using this CPU default setting and not changing it unless the current CPU type and voltage setting can not be detected or is not correct.
- **User Define:** This option lets the user select the voltage manually. You can change values of the "**Core Voltage**", "**I/O Voltage**" and "**DDR Voltage**" option lists by using the arrow up and arrow down keys.

CPU Fast Command Decode:

Two options are available: Disable → Enable. The default setting is *Disable*. With this setting, you may select *Enable* if you want CPU decode address is 1T. We suggest you choose *Disable* for greatest stability. Should you want increased performance then you can select *Enable*.

3-2. Standard CMOS Features Setup Menu

This contains the basic configuration parameters of the BIOS. These parameters include date, hour, VGA card, floppy disk and HDD settings.



Figure 3-3A. Standard CMOS Setup Screen Shot

Date (mm:dd:yy):

You can set the date in this item: month (mm), date (dd) and year (yy).

Time (hh:mm:ss):

You can set the time in this item: hour (hh), minute (mm) and second (ss).

IDE Primary Master / Slave and IDE Secondary Master / Slave:

These items have a sub-menu to let you choose further options. You can refer to figure 3-3B to check what options are available.

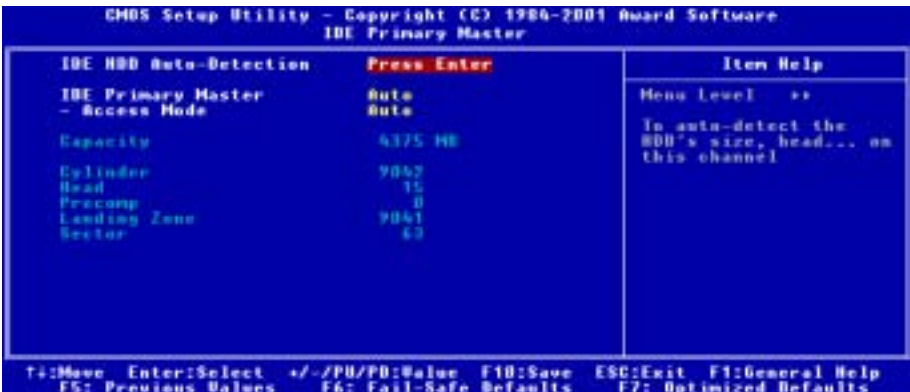

Figure 3-3B. IDE Primary Master Setup Screen Shot

IDE HDD Auto-Detection:

Press the *Enter* key for the BIOS to auto detect all detailed parameters of the hard disk drivers (HDD). If auto detection is successful, the correct values will be shown in the remaining items of this menu.

Note

- ❶ A new IDE HDD must be first formatted, otherwise it can not read/write. The basic step in using a HDD is to run FDISK, and then FORMAT the drive. Most current HDDs have already been subjected to low-level format at the factory, so you can probably skip this operation. Remember though, the primary IDE HDD must have its partition set to active within the FDISK procedure.
- ❷ If you are using an old HDD that is already formatted, auto detection can not detect the correct parameters. You may need to do a low-level format or set the parameters manually, and then check if the HDD is working.

IDE Primary Master:

Three settings are available: *Auto*, *Manual* and *None*. If you choose *Auto*, the BIOS will automatically check what kind hard disk you are using. If you want to set the HDD parameters yourself, make sure you fully understand the meaning of the parameters, and be sure to refer to the manual provided by the HDD manufacture to get the settings right.

Access Mode:

Since old operating systems were only able to support HDDs with capacities no bigger than 528MB, any hard disk with more than 528MB was unusable. AWARD BIOS features a solution to this problem: you can, according to your operating system, choose four operating modes: NORMAL → LBA → LARGE → Auto.

The HDD auto detection option in the sub-menu will automatically detect the parameters of your hard disk and the mode supported.

➤ **CHS (Normal mode):**

Standard normal mode supports hard disks of up to 528MB or less. This mode directly uses positions indicated by Cylinders (CYLS), Heads, and Sectors to access data.

➤ **LBA (Logical Block Addressing) mode:**

The earlier LBA mode can support HDD capacities of up to 8.4GB, and this mode uses a different method to calculate the position of disk data to be accessed. It translates Cylinders (CYLS), Heads and Sectors into a logical address where data is located. The Cylinders, Heads, and Sectors displayed in this menu do not reflect the actual structure of the hard disk, they are just reference values used to calculate actual positions. Currently, all high capacity hard disks support this mode, that's why we recommend you use this mode. Currently, the BIOS can support the INT 13h extension function, enabling the LBA mode to support hard disk drive capacities exceeding 8.4GB.

➤ **Large Mode:**

When the number of cylinders (CYLs) of the hard disk exceeds 1024 and DOS is not able to support it, or if your operating system does not support LBA mode, you should select this mode.

➤ **Auto:**

Just let the BIOS detect your HDD access mode and make the decisions.

• **Capacity:**

This item auto displays your HDD size. Note that this size is usually slightly greater than the size given by a disk checking program of a formatted disk.

Note

All the items below are available when you set the item *Primary IDE Master* to *Manual*.

• **Cylinder:**

When disks are placed directly above one another along the shaft, the circular vertical "slice" consisting of all the tracks located in a particular position is called a cylinder. You can set the number of cylinders for a HDD. The minimum number you can enter is 0, the maximum number you can enter is 65536.

• **Head:**

This is the tiny electromagnetic coil and metal pole used to create and read back the magnetic patterns on the disk (also called the read/write head). You can configure the number of read/write heads. The minimum number you can enter is 0, the maximum number you can enter is 255.

• **Precomp:**

The minimum number you can enter is 0, the maximum number you can enter is 65536.

Warning

Setting a value of 65536 means no hard disk exists.

• **Landing Zone:**

This is a non-data area on the disk's inner cylinder where the heads can rest when the power is turned off. The minimum number you can enter is 0, the maximum number you can enter is 65536.

• **Sector:**

The minimum segment of track length that can be assigned to stored data. Sectors usually are grouped into blocks or logical blocks that function as the smallest units of data permit. You can configure this item to sectors per track. The minimum number you can enter is 0, the maximum number you can enter is 255.

Driver A & Driver B:

If you have installed the floppy disk drive here, then you can select the type of floppy drive it can support. Six options are available: None → 360K, 5.25 in. → 1.2M, 5.25in. → 720K, 3.5 in. → 1.44M, 3.5 in. → 2.88M, 3.5 in.

Floppy 3 Mode Support:

Four options are available: Disabled → Driver A → Driver B → Both. The default setting is *Disabled*. 3 Mode floppy disk drives (FDD) are 3 1/2" drives used in Japanese computer systems. If you need to access data stored in this kind of floppy, you must select this mode, and of course you must have a 3 Mode floppy drive.

Video:

You can select the VGA modes for your video adapter, four options are available: EGA/VGA → CGA 40 → CGA 80 → MONO. The default setting is EGA/VGA.

Halt On:

You can select which type of error will cause the system to halt. Five options are available: All Errors → No Errors → All, But Keyboard → All, But Diskette → All, But Disk/Key.

You can see your system memory list in the lower right box, it shows the *Base Memory*, *Extended Memory* and *total Memory size* configurations in your system. It is detected by the system during boot-up procedure.

3-3. Advanced BIOS Features Setup Menu

In each item, you can press <Enter> at any time to display all the options for this item.

Attention

Advanced BIOS Features Setup Menu has already been set for maximum operation. If you do not really understand each of the options in this menu, we recommend you use the default values.

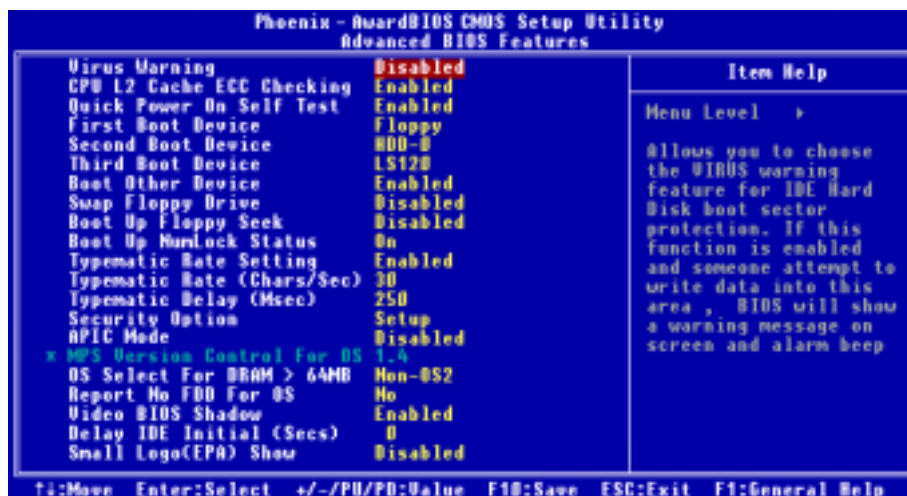

Figure 3-4. Advanced BIOS Features Setup Screen

Virus Warning:

This item can be set to Enabled or Disabled, the default setting being *Disabled*.

When this feature is enabled, if there is any attempt from a software or an application to access the boot sector or the partition table, the BIOS will warn you that a boot virus is attempting to access the hard disk.

CPU L2 Cache ECC Checking:

Two options are available: Enabled or Disabled. The default setting is *Enabled*. This item is used to enable or to disable the CPU level 2 cache ECC checking function.

Quick Power On Self Test:

After the computer has been powered on, the BIOS of the motherboard will run a series of tests in order to check the system and its peripherals. If the Quick Power on Self-Test feature is enable, the BIOS will simplify the test procedures in order to speed up the boot process. The default setting is *Enabled*.

First Boot Device:

When the computer boots up, the BIOS attempts to load the operating system from the devices in the sequence selected in these items: floppy disk drive A, LS120, ZIP100 devices, hard drive C, SCSI hard disk drive or CD-ROM. There are ten options for the boot sequence that you can choose (The default setting is *Floppy*):

Floppy → LS120 → HDD-0 → SCSI → CDROM → HDD-1 → HDD-2 → HDD-3 → ZIP100 → LAN
→ Disabled → Back to Floppy. **(KX7-333 Only)**

Floppy → LS120 → HDD-0 → SCSI → CDROM → HDD-1 → HDD-2 → HDD-3 → ZIP100 → LAN
→ ATA133RAID → Disabled → Back to Floppy. **(KX7-333R Only)**

Second Boot Device:

Description is the same as the *First Boot Device*, the default setting is *HDD-0*.

Third Boot Device:

Description is same as the *First Boot Device*, the default setting is *LS120*.

Boot Other Device:

Two options are available: Disabled or Enabled. The default setting is *Enabled*. This setting allows the BIOS to try to boot devices other than the three which are listed in the above First, Second and Third Boot Devices. If you set to Disabled, the BIOS will boot from only the three kinds of boot devices that are set above.

Swap Floppy Drive:

This item can be set as Disabled or Enabled. The default setting is *Disabled*. When this feature is enabled, you don't need to open the computer case to swap the position of floppy disk drive connectors. Drive A can be set as drive B and drive B can be set as drive A.

Boot Up Floppy Seek:

When the computer boots up, the BIOS detects if the system has a FDD or not. When this item is set to *Enabled*, if the BIOS detects no floppy drive, it will display a floppy disk drive error message. If this item is disabled, the BIOS will skip this test. The default setting is *Disabled*.

Boot Up NumLock Status:

- On: At boot up, the Numeric Keypad is in numeric mode. (Default Settings)
- Off: At boot up, the Numeric Keypad is in cursor control mode.

Typematic Rate Setting:

This item allows you to adjust the keystroke repeat rate. When set to *Enabled*, you can set the two keyboard typematic controls that follow (*Typematic Rate* and *Typematic Rate Delay*). If this item is set to *Disabled*, the BIOS will use the default setting. The default setting is *Enabled*.

Typematic Rate (Chars/Sec):

When you press a key continuously, the keyboard will repeat the keystroke according to the rate you have set (Unit: characters/second) . Eight options are available: 6 → 8 → 10 → 12 → 15 → 20 → 24 → 30 → Back to 6. The default setting is 30.

Typematic Delay (Msec):

When you press a key continuously, if you exceed the delay you have set here, the keyboard will automatically repeat the keystroke according to a certain rate (Unit: milliseconds). Four options are available: 250 → 500 → 750 → 1000 → Back to 250. The default setting is 250.

Security Option:

This option can be set to System or Setup. The default setting is *Setup*. After you have created a password through PASSWORD SETTING, this option will deny access to your system (System) or modification of computer setup (BIOS Setup) by unauthorized users.

- **SETUP:** When you choose Setup, a password is required only when accessing the BIOS Setup. If the correct password is not given, you can't enter the BIOS setup menu.
- **SYSTEM:** When you choose System, a password is required each time the computer boots up. If the correct password is not given, the system will not start.

To disable security, select *Set Supervisor Password* at main menu and then you will be asked to enter password. Do not type anything and just press the *Enter* key and it will disable security. Once security is disabled, the system will boot and you can enter the *BIOS setup menu* freely.

Notice

Don't forget your password. If you forget the password, you will have to open the computer case and clear all information in the CMOS before you can start up the system. But by doing this, you will have to reset all previously set options.

APIC Mode:

Two options are available: Disabled or Enabled. The default setting is *Disabled*. If you set to *Enabled*, the next item will be available to choose. When you set it to *Disabled*, the system will use the default six PCI IRQs for all devices, and will not increase the number of PCI IRQs.

MPS Version Control For OS:

This option specifies which version of MPS the motherboard will use.

Three options available: 1.1 → 1.4. MPS stands for **M**ulti-**P**rocessor **S**pecification. If you use an older OS for dual processor executing, please set this option to 1.1.

OS Select For DRAM > 64MB:

When the system memory is bigger than 64MB, the communication method between the BIOS and the operating system will differ from one operating system to another. If you use OS/2, select *OS2*; if you are using another operating system, select *Non-OS2*. The default setting is *Non-OS2*.

Report No FDD For OS:

Two options are available: No or Yes. The default setting is *No*. When you running some older Windows operating system (such as: Windows® 95) without floppy drive, set this item to *Yes*. Otherwise, set it to *No*.

Video BIOS Shadow:

This option is used to define whether the BIOS on the video card uses the shadow feature or not. You should set this option to Enabled, otherwise the display performance of the system will greatly decrease.

Computer Knowledge: SHADOW

What is the SHADOW? The BIOS of standard video or interface cards is stored in ROM, and it is often very slow. With the Shadow feature, the CPU reads the BIOS on the VGA card and copies it into RAM. When the CPU runs this BIOS, the operation is speeded up.

Delay IDE Initial (Secs):

This item is used to support some old models or special types of hard disks or CD-ROMs. They may need a longer amount of time to initialize and prepare for activation. Since the BIOS may not detect those kinds of devices during system booting. You can adjust the value to fit such devices. Larger values will give more delay time to the device. The minimum number you can enter is 0, the maximum number you can enter is 15. The default setting is 0.

Small Logo(EPA) Show:

Two options are available: Disabled or Enabled. The default setting is *Disabled*. If you set to Enabled, when computer reboot then you can see the EPA logo on the up right corner of the screen.

3-4. Advanced Chipset Features Setup Menu

The Chipset Features Setup Menu is used to modify the contents of the buffers in the chipset on the motherboard. Since the parameters of the buffers are closely related to hardware, if the setup is not correct or is false, the motherboard will become unstable or you will not be able to boot up. If you don't know the hardware very well, use default values (i.e. use the "Load Fail-Safe Defaults" or "Load Optimized Defaults" option).

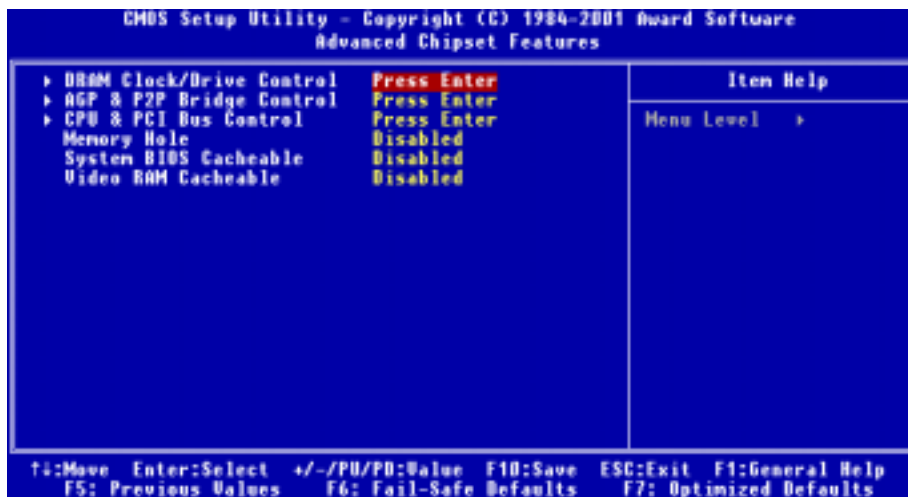

Figure 3-5A. Advanced Chipset Features Setup Screen

You can use the arrow keys to move between the items. Use **PgUP**, **PgDn**, + or - key to change the values. When you have finished setting up the chipset, press <ESC> to go back to the main menu.

Note

The parameters in this screen are for system designers, service personnel, and technically competent users only. Do not reset these values unless you understand the consequences of your changes.

DRAM Clock/Drive Control:

This item can let you set several items concerning the DRAM parameters. If you do not understand what each item does, please keep the default settings. Wrong settings may cause system instability, data loss or even prevent boot up!

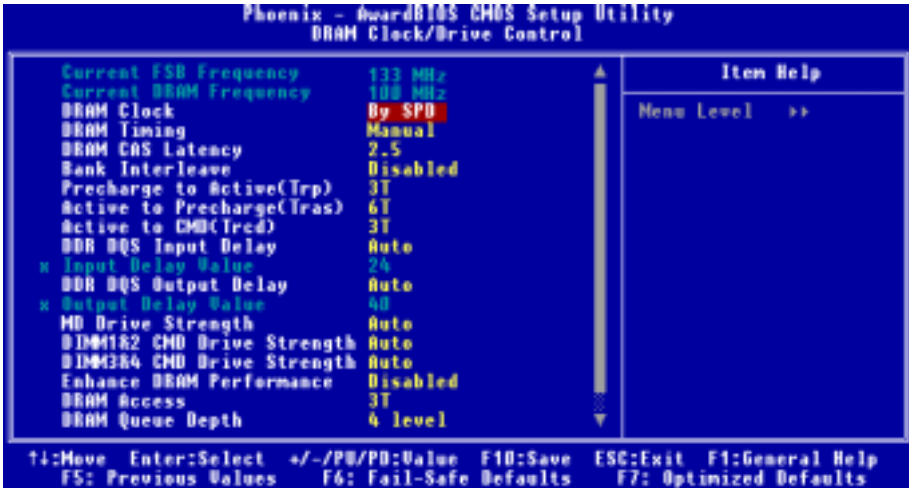

Figure 3-5B. DRAM Clock/Drive Control Upper Screen



Figure 3-5C. DRAM Clock/Drive Control Lower Screen

Current FSB Frequency:

This item will show you the current system front side bus speed.

Current DRAM Frequency:

This item will show you the current DRAM bus speed.

DRAM Clock:

Four options are available: 100 MHz → 133 MHz → 166 MHz → By SPD. The default setting is *By SPD*. You can set the DRAM running speed, but if your DRAM module does not support the set speed, the system may be unstable or unable to boot up! If you set to *By SPD*, the BIOS will read the DRAM module SPD data and automatically set the DRAM running speed to the value stored in it.

Note

The display of this item might be different when you installed the different type of DDR SDRAM. We just show you an example here.

What's SPD?

SPD (Serial Presence Detect) is a feature available on a number of SDRAM/DDR SDRAM DIMM modules that solves industry-wide compatibility problems by making it easier for the BIOS to properly configure the system to fit SDRAM performance profiles.

The SPD device is a small serial EEPROM chip that stores various information about the DIMM module's size, speed, voltage, drive strength, latency timing and the number of row and column addresses. When the BIOS reads these parameters during POST, it automatically adjusts the values in the CMOS Advanced Chipset Features screen for maximum reliability and performance.

Without SPD, the BIOS (or user) must make assumptions about the DIMM's parameters. Many users have found that their system will not boot if they are using non-SPD SDRAM DIMMs. As SDRAM and DDR SDRAM DIMM's is running at very fast clock speed and there is less room for error. An incorrect BIOS assumption about an SDRAM and DDR SDRAM DIMM's parameters can have serious consequences (e.g. failure to boot or fatal exception errors).

DRAM Timing:

Two options are available: Manual or Auto. The default setting is *Manual*. When set to *Auto*, the BIOS will read the DRAM module SPD data and automatically set to the values stored in it. If you set to *Manual*, the following five items will be available to let you make adjustments.

• **DRAM CAS Latency:**

Two options are available: 2.5 and 2. The default setting is 2.5. You can select SDRAM CAS (Column Address Strobe) latency time according your SDRAM specification.

• **Bank Interleave:**

Three options are available: Disabled → 2 Bank → 4 Bank. The default setting is *Disabled*. Depending on your SDRAM module structure, the *4 Bank* setting can offer the best performance. If you choose the wrong setting, the computer system will not run in a stable manner. For detailed information on your SDRAM module, please ask your SDRAM module manufacturer.

• **Precharge to Active (Trp):**

Two options are available: 2T or 3T. The default setting is *3T*.

Trp timing value (Precharge time – time from precharge command to when back can be activated).

• **Active to Precharge (Tras):**

Two options are available: 5T or 6T. The default setting is *6T*.

Tras timing value = Minimum bank active time from activate to precharge of same bank.

• **Active to CMD (Tred):**

Two options are available: 2T or 3T. The default setting is *3T*.

Tred timing value = RAS to CAS latency + rd/wr command delay

DDR DQS Input Delay:

Two options are available: Auto or Manual. The default setting is *Auto*. If you set to *Manual*, then the next item will be available.

Input Delay Value:

This item allows you to adjust the data input strobe delay time of memory. You can key in the HEX number into this section. The minimum number is 0000, and maximum number is 003F.

DDR DQS Output Delay:

Two options are available: Auto or Manual. The default setting is *Auto*. If you set to *Manual*, then the next item will be available.

Output Delay Value:

This item allows you to adjust the data output strobe delay time of memory. You can key in the HEX number into this section. The minimum number is 0000, and maximum number is 00FF.

MD Drive Strength:

Four options are available: Auto → Low → Medium → High. The default setting is *Auto*. This item can adjust the drive strength for data sent to DDR SDRAM. This will depend on your DDR SDRAM specification and numbers to set. With more DDR SDRAM DIMM installed, you may set it to *High*.

DIMM1&2 CMD Drive Strength:

Four options are available: Auto → Low → Medium → High. The default setting is *Auto*. This item can adjust the drive strength for commands sent to DDR SDRAM (this adjustment is for DIMM 1 and DIMM 2 only). This will depend on your DDR SDRAM specification and numbers to set. With more DDR SDRAM DIMM installed, you may set it to *High*.

DIMM3&4 CMD Drive Strength:

Four options are available: Auto → Low → Medium → High. The default setting is *Auto*. This item can adjust the drive strength for commands sent to DDR SDRAM (this adjustment is for DIMM 3 and DIMM 4 only). This will depend on your DDR SDRAM specification and numbers to set. With more DDR SDRAM DIMM installed, you may set it to *High*.

Enhance DRAM Performance:

Two options are available: Disabled or Enabled. The default setting is *Disabled*. This item can improve your system DRAM performance.

DRAM Access:

Two options are available: 2T → 3T. The default setting is *3T*. This item allows you to choose the DRAM access time cycle. 2T gives you quicker DRAM access time than 3T; 3T is a general DRAM setting.

DRAM Queue Depth:

Three options are available: 2 Level → 3 Level → 4 level. The default setting is *4 Level*. This item sets DRAM queue depth to accommodate maximum memory throughput.

DRAM Command Rate:

Two options are available: 2T Command or 1T Command. The default setting is *2T Command*. When the host (northbridge) locates the desired memory address, it then processes the wait state of commands. Set it to *2T Command* for system compatibility or to *1T Command* for system performance.

DCLK Feedback Delay:

Nine options are available: Auto → 0 ps → 120 ps → 240 ps → 360 ps → 480 ps → 600 ps → 720 ps → 840 ps. The default setting is 0. The northbridge via DCLK feedback signal to sense the DRAM clock timing of DRAM module. This item will effect the DRAM module's stability, we suggestion you set to 0.

AGP & P2P Bridge Control:

This item can let you sets several items concerning the AGP parameters. If you do not understand what each item doing, please keep the default settings as well. Wrong settings will cause system unstability or even prevent boot up!

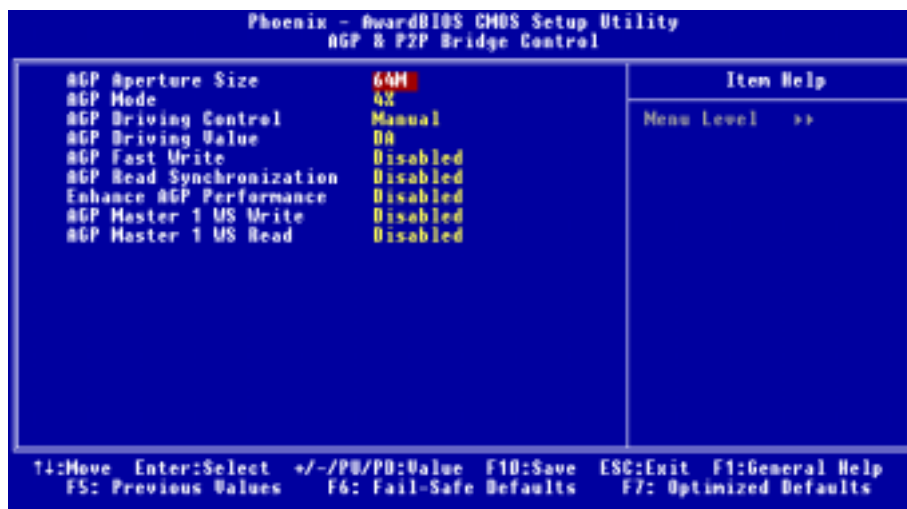

Figure 3-5D. AGP & P2P Bridge Control Screen

AGP Aperture Size:

Seven options are available: 256M → 128M → 64M → 32M → 16M → 8M → 4M → Back to 256M. The default setting is *64M*. This option specifies the amount of system memory that can be used by the AGP device. The aperture is a portion of the PCI memory address range dedicated for graphics memory address space. Host cycles that hit the aperture range are forwarded to the AGP without any translation. See www.agpforum.org for AGP information.

AGP Mode:

Two options are available: 4X → 2X. The default setting is *4X* (When you installed AGP 4X adapter). If you use the older AGP adapter that does not support AGP 4X mode, BIOS will automatically set it to 2X.

AGP Driving Control:

Two options are available: Auto or Manual. The default setting is *Auto*. Choosing *Manual* to key in an AGP Driving Value is described within the next section. It is recommended this field be set to *Auto* in order to avoid any errors in your system.

AGP Driving Value:

This item allows you to adjust the AGP driving force. You can key in the HEX number into this section. The minimum number is 0000, and maximum number is 00FF.

AGP Fast Write:

Two options are available: Disabled or Enabled. The default setting is *Disabled*. If your AGP adapter can support this function, then you can choose *Enabled*. Otherwise, choose *Disabled*.

AGP Read Synchronization:

Two options are available: Disabled or Enabled. The default setting is *Disabled*. This item can control the AGP synchronous when it read the data. If you want to improve system performance, you can set it to *Enabled*. If you have problem to play the video format files, please set this item to *Disabled*.

Enhance AGP Performance:

Two options are available: Disabled or Enabled. The default setting is *Disabled*. This item can improve your AGP display performance.

AGP Master 1 WS Write:

Two options are available: Disabled or Enabled. The default setting is *Disabled*. This implements a single delay when writing to the AGP Bus. When you set it to *Enabled*, two-wait states are used by the system, allowing for greater stability.

AGP Master 1 WS Read:

Two options are available: Disabled or Enabled. The default setting is *Disabled*. This implements a single delay when reading to the AGP Bus. When you set it to *Enabled*, two-wait states are used by the system, allowing for greater stability.

CPU & PCI Bus Control:

This item can let you set several items concerning the PCI parameters. If you do not understand what each item does, please keep the default settings as well. Wrong settings will cause system instability.

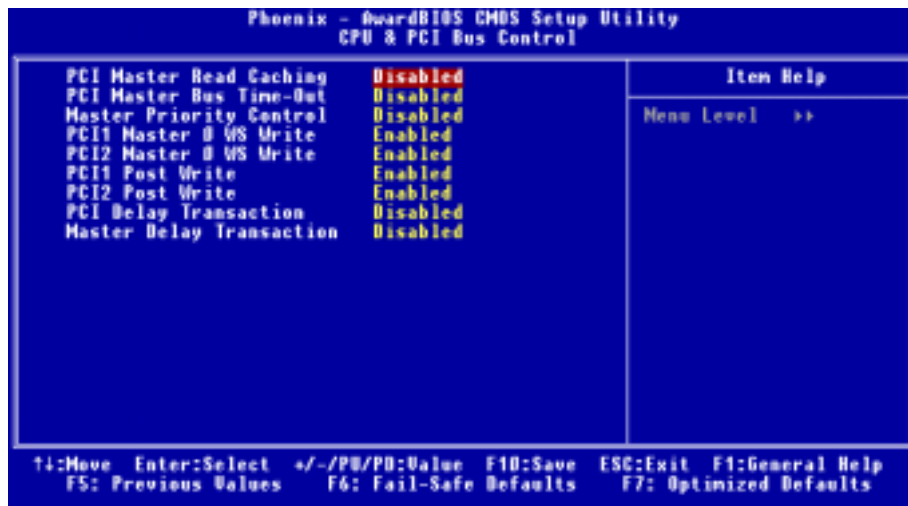

Figure 3-5E. CPU & PCI Bus Control Screen

PCI Master Read Caching:

Two options are available: Disabled or Enabled. The default setting is *Disabled*. This item can set PCI bus master read use cache function.

PCI Master Bus Time-Out:

Eight options are available: Disabled → 001 → 010 → 011 → 100 → 101 → 110 → 111. The default setting is *Disabled*. It can set the time-out period, when after the set time-out period, PCI bus master will force into arbitration.

Master Priority Control:

Four options are available: Disabled → 01 → 10 → 11. The default setting is *Disabled*. The full name of this item is *Master Priority Rotation Control*. When setting to "01", the CPU will always be granted access after the current bus master completes, no matter how many PCI masters are requesting. With setting to "10", if other PCI masters are requesting during the current PCI master grant, the highest priority master will get the bus after the current master completes. But the CPU will be guaranteed to get the bus after that master completes. With setting to "11", if other PCI masters are requesting, the highest priority will get the bus next, then the next highest priority will get the bus, then the CPU will get the bus. In other words, with the above settings, even if multiple PCI masters are continuously requesting the bus, the CPU is guaranteed to get access after every master grant (01), after every other master grant (10) or after every third master grant (11).

PCI1 Master 0 WS Write:

Two options are available: Enabled or Disabled. The default setting is *Enabled*. When *Enabled*, writes to the PCI1 bus are executed with zero wait state (immediately) when PCI1 bus is ready to receive data. If it is set to *Disabled*, the system will wait one state before data is written to the PCI1 bus.

PCI2 Master 0 WS Write:

Two options are available: Enabled or Disabled. The default setting is *Enabled*. When *Enabled*, writes to the PCI2 bus are executed with zero wait state (immediately) when PCI2 bus is ready to receive data. If set to *Disabled*, the system will wait one state before data is written to the PCI2 bus.

PCI1 Post Write:

Two options are available: Disabled or Enabled. The default setting is *Enabled*. When you set it to *Enabled*, it can enable PCI post write buffers to minimize PCI1 master read latency.

PCI2 Post Write:

Two options are available: Disabled or Enabled. The default setting is *Enabled*. When you set it to *Enabled*, it can enable PCI post write buffers to minimize PCI2 master read latency.

PCI Delay Transaction:

Two options are available: Disabled or Enabled. The default setting is *Disabled*. The chipset has an embedded 32-bit posted write buffer to support delay transactions cycles. Select *Enabled* to support compliance with PCI specification version 2.1.

Master Delay Transaction:

Two options are available: Disabled or Enabled. The default setting is *Disabled*. This item settings will effect the system performance.

Back to Advanced Chipset Features Setup Menu Here:

Memory Hole:

Two options are available: Disabled or 15M – 16M. The default setting is *Disabled*. This option is used to free up the memory block 15M-16M. Some special peripherals need to use a memory block located between 15M and 16M. We recommend that you disable this option.

System BIOS Cacheable:

Two options are available: Disabled or Enabled. The default setting is *Disabled*. When you select *Enabled*, you get faster system BIOS executing speed via the L2 cache.

Video RAM Cacheable:

Two options are available: Disabled or Enabled. The default setting is *Disabled*. When you select *Enable*, you get faster video RAM executing speed via the L2 cache. You must check your VGA adapter manual to find out if any compatibility problems will occur.

3-5. Integrated Peripherals

In this menu, you can change the onboard I/O device, I/O port address and other hardware settings.

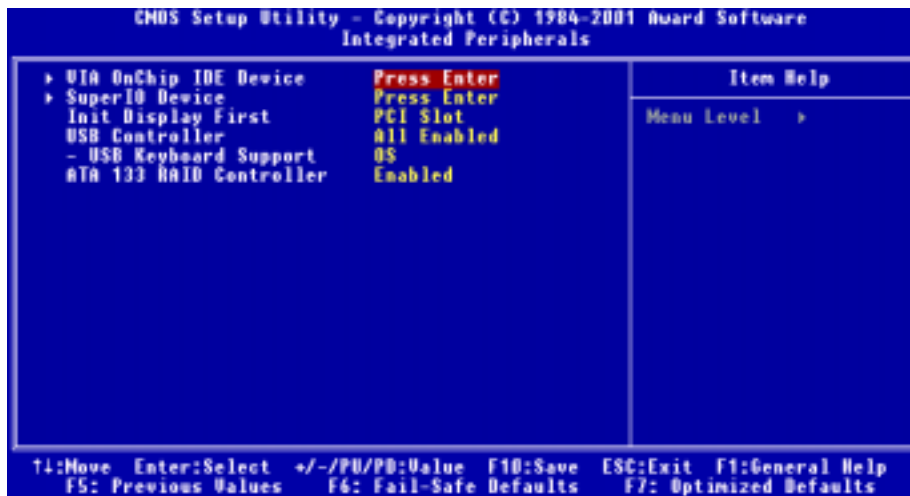

Figure 3-6A. Integrated Peripherals Menu Default Screen

VIA OnChip IDE Device:

This item can let you sets several items concerning the VIA OnChip IDE device parameters.



Figure 3-6B. VIA OnChip IDE Device Screen

IDE Prefetch Mode:

Two options are available: Disabled or Enabled. The default setting is *Enabled*. The onboard IDE drive interfaces supports IDE prefetching for faster drive accesses. If you install a primary and/or secondary add-in IDE interface, set this field to *Disabled* if the interface does not support prefetching.

Onboard IDE-1 Controller:

The onboard IDE 1 controller can be set as Enabled or Disabled.

• Master Drive PIO Mode:

- Auto: The BIOS can auto-detect the transfer mode of the IDE devices in order to set its data transfer rate (Default). You can select the PIO mode from 0 to 4 of the IDE devices in order to set its data transfer rate.

• Slave Drive PIO Mode:

- Auto: The BIOS can auto-detect the transfer mode of the IDE devices in order to set its data transfer rate (Default). You can select the PIO mode from 0 to 4 of the IDE devices in order to set its data transfer rate.

• Master Drive Ultra DMA:

Ultra DMA is a DMA data transfer protocol that utilizes ATA commands and the ATA bus to allow DMA commands to transfer data at a maximum burst rate of 100 MB/sec.

- Disabled: If you encounter the problem of using Ultra DMA devices, you can try to set this item to *Disabled*.
- Auto: When you select Auto, the system automatically determines the optimal data transfer rate for each IDE device. (Default)

• Slave Drive Ultra DMA:

- Disabled: If you encounter the problem of using Ultra DMA devices, you can try to set this item to *Disabled*.
 - Auto: When you select Auto, the system automatically determines the optimal data transfer rate for each IDE device. (Default)
-

Onboard IDE-2 Controller:

The onboard IDE 2 controller can be set as Enabled or Disabled. Description is the same as the item “**Onboard IDE-1 Controller**”. You can refer the above description.

PIO MODE 0 ~ 4 reflects the IDE device data transfer rate. The higher the MODE value is, the better the IDE device data transfer rate. However, it does not mean that the highest MODE value can be selected. You first have to be sure that your IDE device supports this MODE. Otherwise, the hard disk will not be able to operate normally.

Super IO Device:

This item can let you sets several items concerning the Super I/O device parameters.

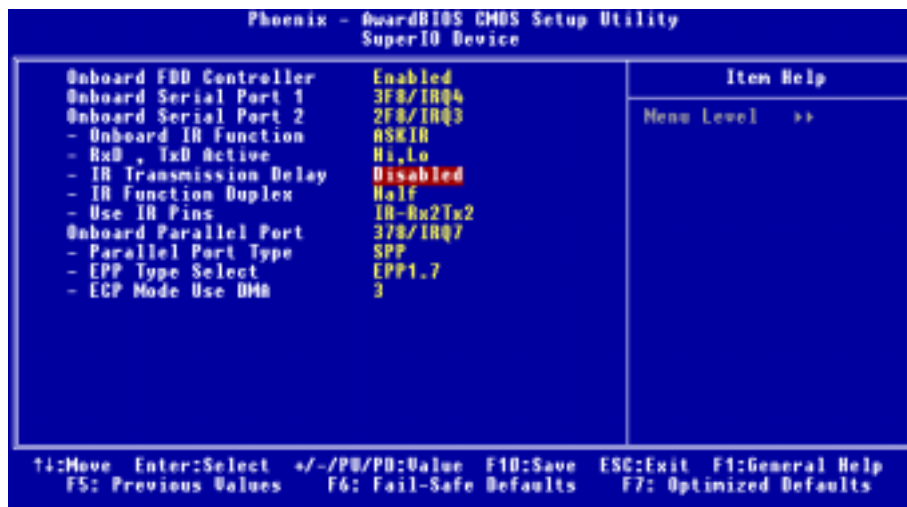

Figure 3-6C. Super IO Device Screen

Onboard FDD Controller:

Two options are available: Disabled or Enabled. The default setting is *Enabled*. This is used to enable or disable the Onboard FDD Controller. If you add a higher performance controller, you will need to *Disable* this feature.

Onboard Serial Port 1:

This item allows you to determine which I/O address the onboard serial port 1 controller will access. Six options are available: Disabled → 3F8/IRQ4 → 2F8/IRQ3 → 3E8/IRQ4 → 2E8/IRQ3 → Auto → Back to Disabled. The default setting is *3F8/IRQ4*.

Onboard Serial Port 2:

This item allows you to determine which I/O address the onboard serial port 2 controller will access. Six options are available: Disabled → 3F8/IRQ4 → 2F8/IRQ3 → 3E8/IRQ4 → 2E8/IRQ3 → Auto → Back to Disabled. The default setting is *2F8/IRQ3*.

If you choose *Disabled*, then the item “**Onboard IR Function**” will disappear.

☛ Onboard IR Function:

Three options are available: IrDA → ASKIR (Amplitude Shift Keyed IR) → Disabled. The default setting is *Disabled*.

When you select the item IrDA or ASKIR, then the following two items will appear.

• **RxD, TxD Active:**

Four options are available: Hi, Hi → Hi, Lo → Lo, Hi → Lo, Lo. The default setting is *Hi, Lo*. Set IR transmission/reception polarity as High or Low.

• **IR Transmission Delay:**

Two options are available: Disabled and Enabled. The default setting is *Enabled*. Set IR transmission delays 4 character-time (40 bit-time) when SIR is changed from RX mode to TX mode.

• **IR Function Duplex:**

Two options are available: Full or Half. The default setting is *Half*.

Select the value required by the IR device connected to the IR port. Full-duplex mode permits simultaneous two-direction transmission. Half-duplex mode permits transmission in only one direction at a time.

• **Use IR Pins:**

Two options are available: RxD2, TxD2 and IR-Rx2Tx2. The default setting is *IR-Rx2Tx2*. If you choose *RxD2, TxD2*, your motherboard must support a COM port IR KIT connection. Otherwise, you can only choose the *IR-Rx2Tx2* to use the IR header on your motherboard to connect your IR KIT. Please use the default setting.

Note

The setting for item “**RxD, TxD Active**”, also called “**TX, RX inverting**”, allows you to determine the activity of RxD and TxD. We set it to “**Hi, Lo**”. If your motherboard BIOS uses “**No**” and “**Yes**” to represent this item, you should set it to the same setting as the KX7-333/KX7-333R. This means that you should set it to “**No, Yes**” in order to match the transfer and receiving speed. If you fail to do so, you will not get an IR connection between the KX7-333/KX7-333R and the other computer.

Onboard Parallel Port:

Four options are available: Disabled → 378/IRQ7 → 278/IRQ5 → 3BC/IRQ7. The default setting is *378/IRQ7*. Select a logical LPT port name and matching address for the physical parallel (printer) port.

• **Parallel Port Type:**

Four options are available: SPP → EPP → ECP → ECP+EPP. Default is *SPP* mode. Select an operating mode for the onboard parallel (printer) port. SPP (Standard Parallel Port), EPP (Extended Parallel Port), ECP (Extended Capabilities Port) or ECP plus EPP.

Select SPP unless you are certain your hardware and software supports both EPP or ECP mode. According to your selection, the following items will appear.

• **EPP Type Select:**

Two options are available: EPP1.9 → EPP1.7. The default setting is *EPP1.7*. When the mode selected for the parallel port mode is EPP, the two EPP mode options are available.

• **ECP Mode Use DMA:**

Two options are available: 1 → 3. The default setting is *3*. When the mode selected for the onboard parallel port is ECP or ECP+EPP, the DMA channel selected can be 1 (Channel 1) or 3 (Channel 3).

Back to Integrated Peripherals Setup Menu Here:

Init Display First:

Two options are available: PCI Slot or AGP. The default setting is *PCI Slot*. When you install more than one display card, you can choose either a PCI display card (PCI Slot) or an AGP display card (AGP) to display the boot-up screen. If you have only installed one display card, the BIOS will detect which slot (AGP or PCI) you installed it, and everything will be taken care of by the BIOS.

USB Controller:

Four options are available: All Disabled → All Enabled → 1 USB Port → 2 USB Port. The default setting is *All Enabled*. This should be enabled if your system has a USB device installed on the system board and you wish to use it. If you add a higher performance controller, you will need to disable this feature. If you choose disable this item, the “USB Keyboard Support” item will disappear in *Integrated Peripherals* menu.

☛ *USB Keyboard Support:*

Two options are available: OS and BIOS. The default setting is *OS*. If your operating system supports a USB keyboard, please set it to *OS*. Only in some situations, such as in a pure DOS environment that does not support a USB keyboard, should you set it to BIOS.

ATA 133 RAID Controller (KX7-333R Only):

Two options are available: Disabled or Enabled. The default setting is *Enabled*. If your motherboard is the KX7-333R, it has the built-in HighPoint 372 chipset that can support Ultra ATA 133 specifications. If you set this controller to Enabled, you can use IDE RAID functions, including RAID 0, RAID 1 and RAID 0+1. This feature enables you to maximize your data storage performance and security. For detailed information, please refer to the Chapter 4.

3-6. Power Management Setup Menu

When the computer operates normally, it is in Normal mode. In this mode, the Power Management Program will monitoring the access to video, I/O ports and drives, and the operating status of the keyboard, mouse and other device. These are referred to as Power Management Events. In cases where none of these events occur within setting time, the system enters the power saving mode. When one of the controlled events occurs, the system immediately returns to normal mode and operates at its maximum speed.

1. In the Main Menu, select “**Power Management Setup**” and press <Enter>. The following screen is displayed:

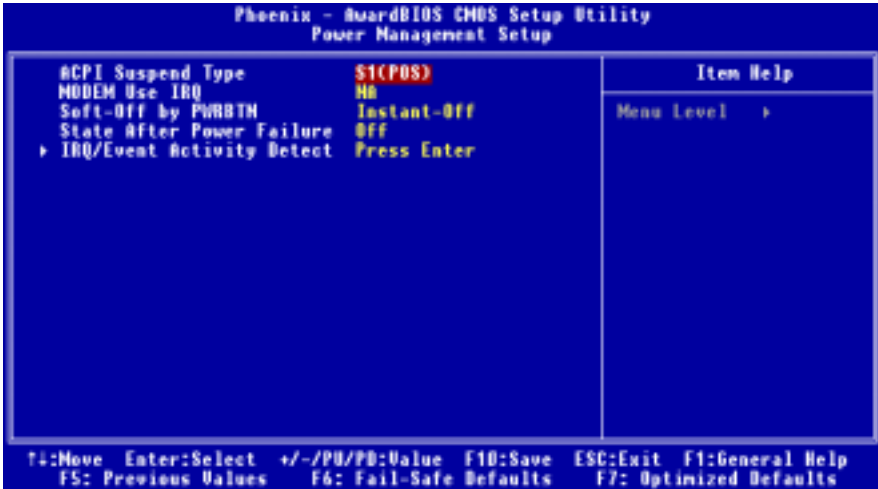

Figure 3-7A. Power Management Setup Main Menu

2. You can use the arrow keys to move between the items. Use **PgUP**, **PgDn**, + or - key to change the values. When you have finished setting up the chipset, press <Esc> to go back to the main menu.
3. After you have configured the Power Management feature, press <Esc> to go back to the Main Menu.

We are now going to briefly explain the options in this menu:

ACPI Function (Advanced Configuration and Power Interface):

ACPI gives the operating system direct control over the power management and Plug and Play functions of a computer. The BIOS fully support the ACPI functions. If you want ACPI functions to work normally, you should notice two things. One is your operating system must support ACPI, as of now only Microsoft® Windows® 2000, Windows® ME and Windows® XP supports these functions. The second thing is that all devices and add-on cards in your system must fully support ACPI, both hardware and software (drivers). If you want to know if your devices or add-on cards support ACPI or not, please contact the device or add-on card manufacture for more information. If you want to know more about ACPI specifications, please go to the address below for more detailed information:

<http://www.teleport.com/~acpi/acpihtml/home.htm>

ACPI requires an ACPI-aware operating system. ACPI features include:

- Plug and Play (including bus and device enumeration) and APM functionality normally contained in the BIOS.
- Power management control of individual devices, add-in cards (some add-in cards may require an ACPI-aware driver), video displays, and hard disk drives.
- A Soft-off feature that enables the operating system to power off the computer.
- Support for multiple wake-up events (see Table 3-6-1).
- Support for a front panel power and sleep mode switch. Table 3-6-2 describes the system states based on how long the power switch is pressed, depending on how ACPI is configured with an ACPI-aware operating system.

System States and Power States

Under ACPI, the operating system directs all system and device power state transitions. The operating system puts devices in and out of low-power states based on user preferences and knowledge of how devices are being used by applications. Devices that are not being used can be turned off. The operating system uses information from applications and user settings to put the system as a whole into a low-power state.

The table below describes which devices or specific events can wake the computer from specific states.

Table 3-6-1: Wake Up Device and Events

These device/events can wake up the computer.....from this state
Power switch	Sleeping mode or power off mode
RTC alarm	Sleeping mode or power off mode
PCI Card (PME)	Sleeping mode or power off mode
Modem	Sleeping mode or power off mode
IR command	Sleeping mode
USB	Sleeping mode
PS/2 keyboard	Sleeping mode
PS/2 mouse	Sleeping mode

Table 3-6-2: Effect of Pressing the Power Switch

If the system is in this state.....and the power switch is pressed forthe system enters this state
Off	Less than four seconds	Power on
On	More than four seconds	Soft off/Suspend
On	Less than four seconds	Fail safe power off
Sleep	Less than four seconds	Wake up

ACPI Suspend Type:

Two options are available: S1 (POS) or S3 (STR). The default setting is *S1 (POS)*. Generally, ACPI has six states: System S0 state, S1 state, S2 state, S3 state, S4 state, S5 state. S1 and S3 states are described below:

The S1 (POS) State (POS means Power On Suspend):

While the system is in the S1 sleeping state, its behavior is as described below:

- The processor is not executing instructions. The processor's complex context is maintained.
- Dynamic RAM context is maintained.
- Power Resources are in a state compatible with the system S1 state. All Power Resources that supply a System Level reference of S0 are in the OFF state.
- Devices states are compatible with the current Power Resource states. Only devices which solely reference Power Resources which are in the ON state for a given device state can be in that device state. In all other cases, the device is in the D3 (off) state.
- Devices that are enabled to wake the system and that can do so from their current device state can initiate a hardware event which transitions the system state to S0. This transition causes the processor

to continue execution where it left off.

To transition into the S1 state, the operating software does not have to flush the processor's cache.

The S3 (STR) State (STR means Suspend to RAM):

The S3 state is logically lower than the S2 state and is assumed to conserve more power. The behavior of this state is defined as follows:

- Processor is not executing instructions. The processor complex context is not maintained.
- Dynamic RAM context is maintained.
- Power Resources are in a state compatible with the system S3 state. All Power Resources that supply a System Level reference of S0, S1, or S2 are in the OFF state.
- Devices states are compatible with the current Power Resource states. Only devices which solely reference Power Resources which are in the ON state for a given device state can be in that device state. In all other cases, the device is in the D3 (off) state.
- Devices that are enabled to wake the system and that can do so from their current device state can initiate a hardware event which transitions the system state to S0. This transition causes the processor to begin execution at its boot location. The BIOS performs initialization of core functions as required to exit an S3 state and passes control to the firmware resume vector. Please see the ACPI Specification Rev. 1.0 book section 9.3.2 for more details on BIOS initialization.

From the software point of view, this state is functionally the same as the S2 state. The operational difference can be that some Power Resources that could be left ON in the S2 state might not be available to the S3 state. As such, additional devices can be required to be in logically lower D0, D1, D2, or D3 state for S3 than S2. Similarly, some device wake events can function in S2 but not S3.

Because the processor context can be lost while in the S3 state, the transition to the S3 state requires that the operating software flush all dirty cache to DRAM.

*** Above information for system S1 were refer to ACPI Specification Rev. 1.0.**

Modem Use IRQ:

Eight items available: NA → 3 → 4 → 5 → 7 → 9 → 10 → 11 → Back to NA. The default setting is NA. You can specify the IRQ for modem use.

Soft-Off by PWRBTN:

Two items available: Delay 4 Sec or Instant-Off. The default setting is *Instant-Off*. It is activated when the user presses the power button for more than four seconds while the system is in the working state, then the system will transition to the soft-off (Power off by software). This is called the power button over-ride.

State After Power Failure:

This setting lets you set the system action after a power failure. Three options are available: Auto → On → Off. The default setting is *Off*. This item lets you set the system power state when power recovers. If you set it to *Off*, when power returns, whatever state your computer was in before the power failure, the system will always turn off. If you set it to *On*, when power returns, whatever state your computer was in before the power failure, the system will always turn on. If you set it to *Auto*, when the power returns, the computer return to the previous power state.

IRQ/Event Activity Detect:

The following is a list of IRQ's (Interrupt **Re**quests) and list of the events. When an I/O device wants to gain the attention of the operating system, it causes an IRQ or event to occur. When the operating system is ready to respond to the request, it interrupts itself and performs the service.

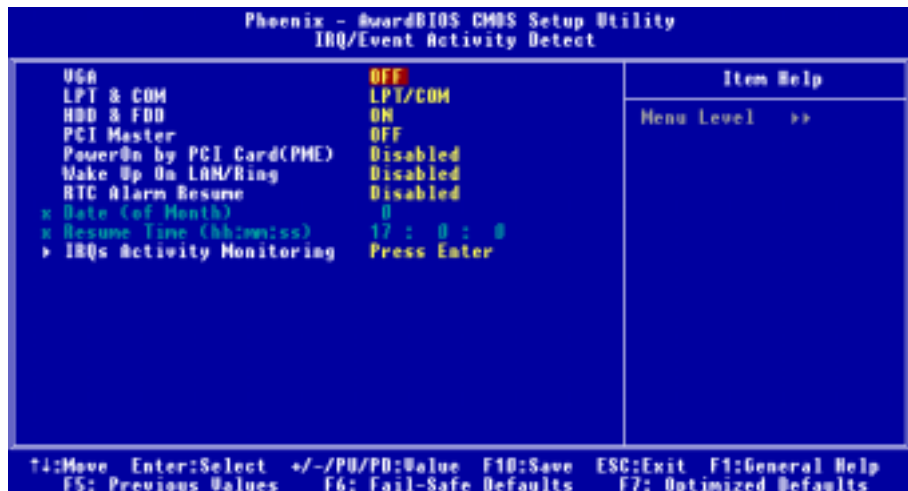

Figure 3-7B. IRQ/Event Activity Detect Setup Menu

VGA:

Two items available: OFF or ON. The default setting is *OFF*. When set to *ON*, any event occurring at a VGA port will awaken a system that has powered down.

LPT & COM:

Four items are available: NONE → LPT → COM → LPT/COM. The default setting is *LPT/COM*. When set to *LPT/COM*, any event occurring at a LPT (printer) or COM (serial) port will awaken a system that has powered down.

HDD & FDD:

Two items are available: OFF or ON. The default setting is *ON*. When set to *ON*, any event affecting a hard disk drive or floppy drive port will awaken a system that has powered down.

PCI Master:

Two items are available: OFF or ON. The default setting is *OFF*. When set to *ON*, any event affecting the PCI Master signal will awaken a system that has powered down.

PowerOn by PCI Card (PME):

Two items are available: Disabled or Enabled. The default setting is *Disabled*. When set to *Enabled*, any event affecting PCI card (PME) will awaken a system that has powered down.

Wake Up On LAN/Ring :

Two items are available: Disabled or Enabled. The default setting is *Disabled*. When set to *Enabled*, any event affecting the LAN or modem ring will awaken a system that has powered down. The effective signal must come from WOL or WOR.

RTC Alarm Resume:

Two items are available: Disabled or Enabled. The default setting is *Disabled*. When set to *Enabled*, you can set the date and time at which the RTC (real-time clock) alarm awakens the system from Suspend mode.

☛ Date (of Month) / Resume Time (hh:mm:ss):

You can set the Date (month) Alarm and Time Alarm (hh:mm:ss). Any event occurring will awaken a system that has powered down.

IRQs Activity Monitoring:

The following is a list of IRQ's (Interrupt **Re**quests). When an I/O device wants to gain the attention of the operating system, it causes an IRQ to occur. When the operating system is ready to respond to the request, it interrupts itself and performs the service.

When one of the specified events occurs, the count down for entry into the power saving mode goes back to zero. Since the computer will enter a power saving mode only after a specified inactivity delay (time specific for Doze, Standby and Suspend modes) and after there has been no activity during this time period, any event will cause the computer to re-count the time elapsed. Resume events are operations or signals that cause the computer to resume time counting.



Figure 3-7C. IRQ Activity Monitoring Setup Menu

All Interrupt Event:

Two items available: Off or Manual. The default setting is *Manual*. When you set this item to *Manual*, the following IRQ events will be available for adjustment.

When set to *Disabled*, activity will neither prevent the system from going into a power management mode nor awaken it. Each item has two options: Enabled → Disabled.

- IRQ3 (COM 2): The default setting is *Enabled*.
- IRQ4 (COM 1): The default setting is *Enabled*.
- IRQ5 (LPT 2): The default setting is *Enabled*.
- IRQ6 (Floppy Disk): The default setting is *Enabled*.
- IRQ7 (LPT 1): The default setting is *Enabled*.
- IRQ8 (RTC Alarm): The default setting is *Disabled*.
- IRQ9 (IRQ2 Redir): The default setting is *Disabled*.
- IRQ10 (Reserved): The default setting is *Disabled*.
- IRQ11 (Reserved): The default setting is *Disabled*.
- IRQ12 (PS/2 Mouse): The default setting is *Enabled*.
- IRQ13 (Coprocessor): The default setting is *Enabled*.
- IRQ14 (Hard Disk): The default setting is *Enabled*.
- IRQ15 (Reserved): The default setting is *Disabled*.

3-7. PnP/PCI Configurations Setup Menu

In this menu, you can change the INT# and IRQ# of the PCI bus and other hardware settings.



Figure 3-8A. PnP/PCI Configurations Setup Menu

Force Update ESCD:

Two options are available: Disabled or Enabled. The default setting is *Disabled*. Normally, you should leave this field Disabled. Select Enabled to reset Extended System Configuration Data (ESCD) when you exit Setup if you have installed a new add-on and the system reconfiguration has caused a serious conflict that prevents the operating system from booting.

Computer Knowledge: ESCD (Extended System Configuration Data)

The ESCD contains the IRQ, DMA, I/O port, memory information of the system. This is a specification and a feature specific to the Plug & Play BIOS.

Resources Controlled By:

When resources are controlled manually, assign each system interrupt as one of the following types, depending on the type of device using the interrupt:

Legacy ISA devices compliant with the original PC AT bus specification require a specific interrupt (such as IRQ4 for serial port 1). *PCI PnP* devices comply with the Plug and Play standard, whether designed for the PCI or legacy ISA bus architecture.

Two options are available: Auto (ESCD) or Manual. The default setting is *Auto (ESCD)*. The Award Plug and Play BIOS has the capability to automatically configure all boot and Plug and Play compatible devices. If you select Auto (ESCD), all of the interrupt request (IRQ) fields become unselectable, as the BIOS automatically assigns them.

IRQ Resources:

If you have trouble in assigning the interrupt resources automatically, you can select *Manual* to set which IRQs assigned to which PCI device or reserve it. See the screen shot below.

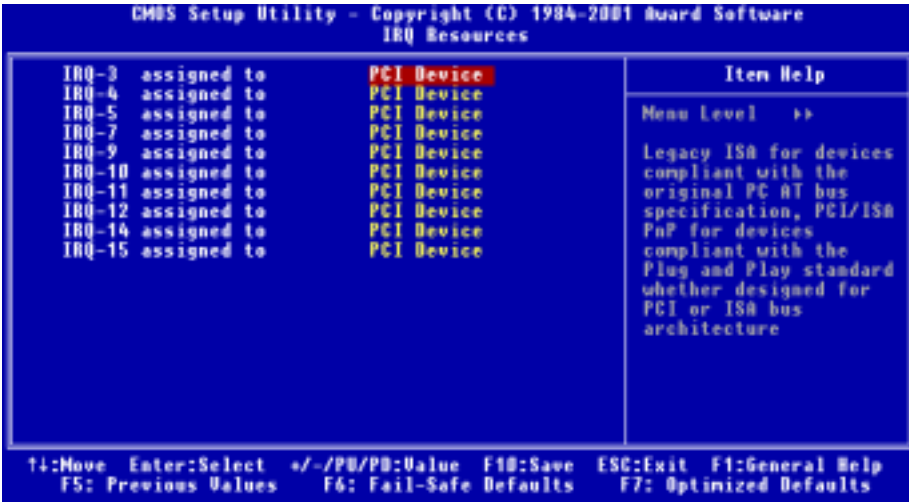

Figure 3-8B. IRQ Resources Setup Menu

PCI/VGA Palette Snoop:

Two options are available: Disabled or Enabled. The default setting is *Disabled*. This option allows the BIOS to preview VGA Status, and to modify the information delivered from the Feature Connector of the VGA card to the MPEG Card. This option can set the display inversion to black after you have used the MPEG card.

Assign IRQ For VGA:

Two options are available: Disabled or Enabled. The default setting is *Enabled*. Name the interrupt request (IRQ) line assigned to the USB/VGA/ACPI (if any) on your system. Activity of the selected IRQ always awakens the system.

You can assign an IRQ for the either PCI or AGP VGA or *Disabled*.

Assign IRQ For USB:

Two options are available: Disabled or Enabled. The default setting is *Enabled*. If you need free up another IRQ, you can choose to disable this item to an IRQ. However, some situations in Windows® 95 may cause the USB port to malfunction or experience other problems!

PIRQ 0 Use IRQ No. ~ PIRQ 3 Use IRQ No.:

Eleven options are available: Auto, 3, 4, 5, 7, 9, 10, 11, 12, 14, 15. Default setting is *Auto*. This item allows the system to automatically specify the IRQ number for the device installed on PCI slots. This means that the system can specify the fixed IRQ number for the device installed on the PCI slots (PCI slot 1 to PCI slot 6). This is a useful function for when you want to fix the IRQ for a specific device.

For example, if you want to move your hard disk to another computer and don't want to re-install Windows® NT or Windows® 2000, you can simply specify the IRQ for the device installed on the new computer to fit the original computer settings.

This feature is for the operating system that will record and fix the PCI configuration status if you want to change it.

For the relations between the hardware layout of PIRQ (the signals from the VIA VT8233 chipset), INT# (means PCI slot IRQ signals) and devices, please refer to the table below:

SIGNALS	PCI Slot 1	PCI Slot 2	PCI Slot 3	PCI Slot 4	PCI Slot 5	PCI Slot 6
PIRQ 0 Assignment	INT A	INT B	INT B	INT D	INT C	INT D
PIRQ 1 Assignment	INT B	INT D	INT A	INT A	INT D	INT B
PIRQ 2 Assignment	INT C	INT C	INT D	INT B	INT A	INT C
PIRQ 3 Assignment	INT D	INT A	INT C	INT C	INT B	INT A

- USB used INT D.
- Each PCI slot has four INT#s (INT A ~ INT D), and the AGP slot has two INT# (INTA and INT B).

Note

- PCI slot 1 shares IRQ signals with the AGP slot.
- PCI-4 and USB controllers share an IRQ.
- If you want to install two PCI cards into those PCI slots that share IRQ with one another at the same time, you must make sure that your OS and PCI devices' driver supports the IRQ sharing function.
- PCI slot 5 shares IRQ signals with the HPT 372 IDE controller (supports Ultra DMA 133). The driver for HPT 372 IDE controller supports IRQ sharing with other PCI devices. But if you install a PCI card that doesn't allow IRQ sharing with other devices into PCI slot 5, you may encounter problems. Furthermore, if your Operating System doesn't allow peripheral devices to share IRQ signals with each other, such as Windows® NT for example, you can't install a PCI card into PCI slot 5. **(KX7-333R Only)**
- HPT 372 IDE controller is designed to support high-speed and high performance mass storage devices. Thus, we suggest that you don't connect non-disk devices that use ATA/ATAPI interfaces, such as a CD-ROM, to HPT 372 IDE connector (IDE3 & IDE4). **(KX7-333R Only)**

3-8. PC Health Status

You can set the warning and shutdown temperatures for your computer system, and you can check the fan speeds and power supply voltages of your computer system. The features are useful for monitoring all the important parameters within your computer system. We call it the *PC Health Status*.

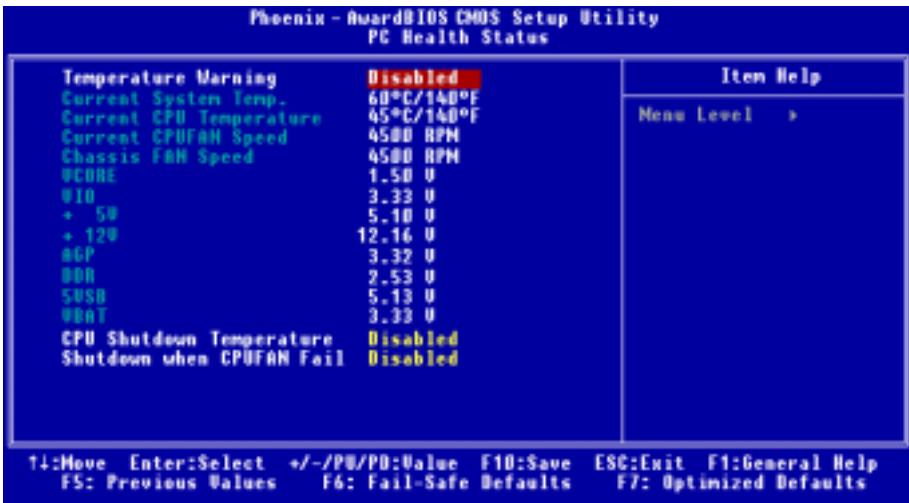

Figure 3-9. PC Health Status Screen Shot

Temperature Warning:

Eight options are available: Disabled → 50°C/122°F → 53°C/127°F → 56°C/133°F → 60°C/140°F → 63°C/145°F → 66°C/151°F → 70°C/158°F. The default setting is *Disabled*. You can set the processor warning temperature here. If the processor temperature exceeds the settings value, the system will give you an alarm message or sound to remind you that the processor is overheating.

All Voltages, Fans Speed and Thermal Monitoring:

These items list the current states of the CPU and environment (using TCPU1 and TSYS1 to detect them.) temperatures as well as fan speeds (CPU fan and chassis fan). It can't be changed by the user.

The following items list the voltage states of the system power. It is also unchangeable.

CPU Shutdown Temperature:

Five options are available: Disabled → 60°C/140°F → 65°C/149°F → 70°C/158°F → 75°C/167°F. The default setting is *Disabled*. You can set the processor shutdown temperature here. If the processor temperature exceeds the settings value, system will force to shutdown to protect the processor not overheat.

Shutdown when CPUFAN Fail:

Two options are available: Disabled or Enabled. The default setting is *Disabled*. If you set it to *Enabled*, if CPUFAN out of order, system will force to shutdown to protect the processor not overheat.

Note

The hardware monitoring features for temperatures, fans and voltages will occupy the I/O address from 294H to 297H. If you have a network adapter, sound card or other add-on cards that might use those I/O addresses, please adjust your add-on card I/O address, to avoid the use of those addresses.

3-9. Load Fail-Safe Defaults

When you press <Enter> on this item you get a confirmation dialog box with a message similar to:

Load Fail-Safe Defaults (Y/N)? **N**

Pressing “Y” loads the BIOS default values for the most stable, minimal-performance system operations.

3-10. Load Optimized Defaults

When you press <Enter> on this item you get a confirmation dialog box with a message similar to:

Load Optimized Defaults (Y/N)? **N**

Pressing “Y” loads the default values that are factory settings for optimal performance system operations.

3-11. Set Password

Set Password: Can enter but do not have the right to change the options of the setup menus. When you select this function, the following message will appear at the center of the screen to assist you in creating a password.

ENTER PASSWORD:

Type the password, up to eight characters in length, and press <Enter>. The password typed now will clear any previously entered password from CMOS memory. You will be asked to confirm the password. Type the password again and press <Enter>. You may also press <Esc> to abort the selection and not enter a password.

To disable a password, just press <Enter> when you are prompted to enter the password. A message will confirm the password will be disabled. Once the password is disabled, the system will boot and you can enter Setup freely.

PASSWORD DISABLED.

When a password has been enabled, you will be prompted to enter it every time you try to enter Setup. This prevents an unauthorized person from changing any part of your system configuration. Additionally, when a password is enabled, you can also require the BIOS to request a password every time your system is rebooted. This would prevent unauthorized use of your computer. You determine when the password is required within the BIOS Features Setup Menu and its Security option. If the Security option is set to *System*, the password will be required both at boot and at entry to Setup. If set to *Setup*, prompting only occurs when trying to enter Setup.

3-12. Save & Exit Setup

Pressing <Enter> on this item asks for confirmation:

Save to CMOS and EXIT (Y/N)? Y

Pressing “Y” stores the selections made in the menus in CMOS - a special section of memory that stays on after you turn your system off. The next time you boot your computer, the BIOS configures your system according to the Setup selections stored in CMOS. After saving the values the system is restarted again.

3-13. Exit Without Saving

Pressing <Enter> on this item asks for confirmation:

Quit without saving (Y/N)? Y

This allows you to exit Setup without storing in CMOS any change. The previous selections remain in effect. This exits the Setup utility and restarts your computer.

Chapter 4. RAID Setting Guide

For detail RAID introduce and concept, you can found it on our WEB site “**Technological Terms**”, or you can search the concerning information on Internet. We do not description it on this manual.

4-1. The features of RAID on the KX7-333R

The KX7-333R supports Striping (RAID 0), Mirroring (RAID 1), or Striping/Mirroring (RAID 0+1) operation. For the striping operation, the identical drives can read and write data in parallel to increase performance. The Mirroring operation creates a complete backup of your files. Striping with Mirroring operation offers both high read/write performance and fault tolerance although requiring 4 hard disks in order to do so.

4-2. RAID SETUP on the KX7-333R

Enter Advanced BIOS Features in the BIOS setup. Change the settings of “**First Boot Device**”, “**Second Boot Device**” and “**Third Boot Device**” to read *ATA133RAID*. See Figure 4-1.

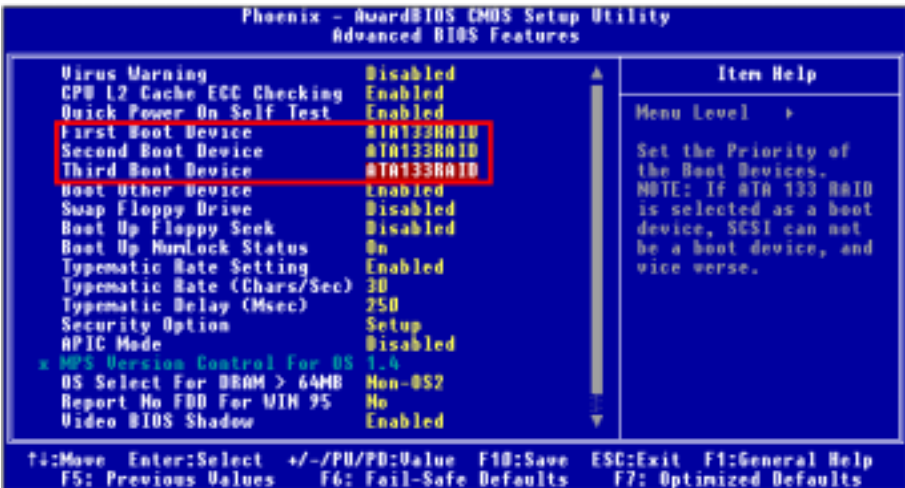

Figure 4-1. RAID settings in BIOS

4-3. The BIOS Setting Menu



Reboot your system. Press **<CTRL>** and **<H>** key while booting up the system to enter the BIOS setting menu. The main menu of BIOS Setting Utility appears as below:

For selecting the option in the menu, you may:

- Press **F1** to view array status.
- Press **↑ ↓** (up, down arrow) to choose the option you want to confirm or to modify.
- Press **Enter** to confirm the selection.
- Press **Esc** to return to top menu.

NOTE

If you want to create a RAID 0 (striping) array or RAID 0+1 array, all data in your hard disk will first be erased! Please backup the hard disk data before creating a RAID array. If you want to create a RAID 1 (mirroring) array, please be sure which hard disk is the source disk and which one is the destination disk. If you make a mistake, you may copy the blank data to the source disk, which will result in both hard disks becoming blank!

4-3-1. OPTION 1: Create Array

This item allows you to create a RAID array.

After you had selected the function from the main menu, press the <Enter> key to enter the sub menu as shown below:

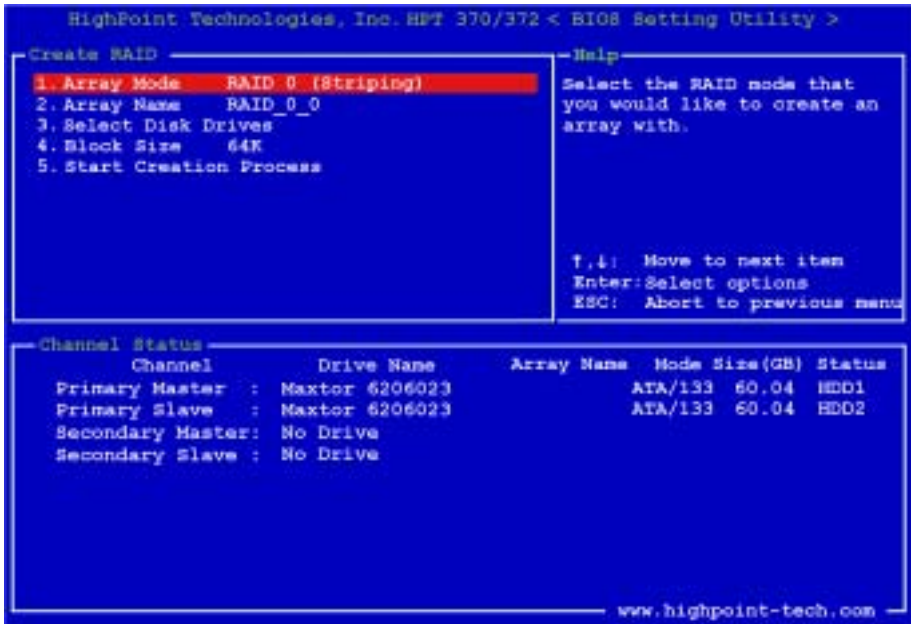

Array Mode:

This item allows you to select the appropriate RAID mode for the desired array. There are four modes to choose.

Note

It is highly recommended to attach hard disks with the same brand and same model when defining a RAID array.

• **RAID 0 (Striping) for Performance:**

This item is recommended for high performance usage. Requires at least 2 disks.

• **RAID 1 (Mirroring) for Data Protection:**

This item is recommended for data security usage. Requires at least 2 disks.

• **RAID 0/1 (Mirrored Striping):**

This item is recommended for data security and high performance usage. Allows Mirroring with a Strip Array. Require four drives.

JBOD (Volume):

This item is recommended for high capacity without redundancy or performance features usage.
Requires at least 2 disks.

Array Name:

You can give a name of your array here.

Select Disk Drives:

This item allows you to select the disk drives to be used with the RAID array.

Block Size:

This item allows you to select the block size of the RAID array. There are eight options available: 16K, 32K, 64K, 128K, 256K, 512K, 1M and 2M.

Start Creation Process:

After you have made your selection, choose this item and press <Enter> to start creation.

4-3-2. OPTION 2: Delete Array

This item allows you to remove a RAID Array on this onboard IDE RAID controller.

Note: After you have made and confirmed this selection, all the data stored in the hard disk will be lost. (The entire partition configuration will be deleted too.)

4-3-3. OPTION 3: Create/Delete Spare

Create Spare:

In the menu zone, select item “3. Create/Delete Spare” and press <Enter> to confirm.

If you are not creating the RAID system yet, screen will show you the warning message, tell you the current system do not create the RAID system. If you choose create the RAID system, then you can select the spare disk you want to create.

In the validated channel status zone, select the spare disk to be added and press <Enter> to confirm.

Delete Spare:

In the menu zone, select item “**3. Create/Delete Spare**” and press <Enter> to confirm.

In the validated channel status zone, select the spare disk to be removed and press <Enter> to confirm.

Note

You can create more than one spare disk in the system, if you want to remove them, do the steps mentioned in “**Delete Spare**” several times, then you can delete all the spare disks you created.

4-3-4. OPTION 4: Select Boot Disk

```

HighPoint Technologies, Inc. HPT 370/372 < BIOS Setting Utility >

Main Menu -----Help-----
1. Create Array
2. Delete Array
3. Create/Delete Spare
4. Select Boot Disk

F1: View Array Status
↑,↓: Move to next item
Enter: Confirm the selection
ESC: Exit from the utility

Channel Status -----
Channel      Drive Name      Array Name      Mode Size(GB) Status
(*) Primary Master : Maxtor 6206023      ATA/133  60.04  HDD1
( ) Primary Slave  : Maxtor 6206023      ATA/133  60.04  HDD2
Secondary Master: No Drive
Secondary Slave : No Drive

www.highpoint-tech.com

```

This item allows you to select the boot disk among the hard disk(s).

Use the up/down arrow to select the menu option to “**Select Boot Disk**” and press <Enter>. In the Channel Status, select the channel you would like to set as bootable disk and press <Enter>, an asterisk appears in the parentheses to indicate that the channel has been selected.

Tips

We suggest you to set the RAID function use “**RAID Management Software**” provide on the product CD-ROM, it will give you more convenience and more help information to show you how to create the RAID system. The detailed of software operation, you can refer the software “**Help**” menu.



Chapter 5. HPT 372 Driver Installation

Here we will show you the driver installation procedure under various operating systems.

5-1. DOS®

This IDE RAID BIOS supports DOS® 5.x (or above) and Windows® 3.1x without the software driver.

5-2. Windows® 98 SE

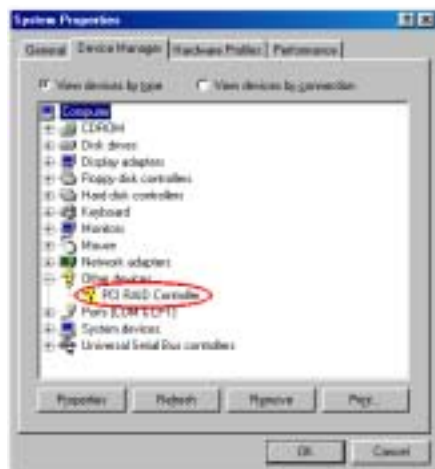

Step 1: After the Windows® 98 SE operating system has been installed and rebooted successfully, go to the “Control Panel” → “System Properties” → “Device Manager”. You can see the driver is not yet installed, and there is a device named “? PCI Mass Storage Controller” under “Other devices”.

Step 2: Insert the KX series CD into your CD-ROM drive. It should execute the program automatically. If not, you can go to the CD location and execute the execution file at the main directory of the CD. After it has been executed, you will see the screen below.



Step 3: Move the cursor to “HPT 37X Driver” and click on it. You will go to the next screen.



Step 4: The “InstallShield Wizard” shows up, and it will go to the next screen for a while.



Step 5: You will now see the welcome screen and its dialogue box. Click “Next>” to go on.



Step 8: Choose “Yes, I want to restart my computer now.” in the check box and click “Finish” restart your computer to finish the drivers update.



Step 6: The program will start to install the drivers and show you the percentage of files installed.



Step 9: After rebooting the system, go to the “Control Panel” → “System Properties” → “Device Manager”. Now you can see that the new driver is installed under the item “SCSI controllers”.



Step 7. Windows has completed installing the driver. Click “Finish” to end the installation.

5-3. Windows® 2000

Step 1: Insert the KX series CD into your CD-ROM drive. It should execute the program automatically. If not, you can go to the CD location and execute the execution file at the main directory of the CD. After it has been executed, you will see the screen below.



Step 2: Move the cursor to “HPT 37X Driver” and click on it. You will go to the next screen.



Step 3: The “InstallShield Wizard” shows up, and it will go to the next screen for a while.



Step 4: You will now see the welcome screen and its dialogue box. Click “Next>” to go on.



Step 5: The “Digital Signature Not Found” menu show up. Click “Yes” to go on.



Step 6: Windows has completed installing the driver. Click “Finish” to end the installation.



Step 7: Choose “Yes, I want to restart my computer now.” in the check box and click “Finish” restart your computer to finish the driver update.



Step 8: The “Digital Signature Not Found” menu appears. Click “Yes” to continue.



Step 9: Go to the “Control Panel” → “System Properties” → “Device Manager”. Now you can see that the driver is installed under the item of “SCSI and RAID controllers”.

Installing the driver (During a fresh Windows® 2000 installation)

Note: Follow the standard procedures for installing Windows® 2000.

1. During the first part of the setup procedure, Windows® 2000 will prompt you to press “F6” key to specify an additional device. Press “F6” key, and let Windows continue on with setup. It will continue to scroll through various device listings for several minutes. It will then prompt you to press the “S” key to add a device.
2. Press “S” key, and insert the HPT 372 driver diskette. Press <Enter> when prompted and allow Windows® 2000 to install the HPT 372 drivers.
3. Windows® 2000 will continue and complete the installation procedure.

Chapter 6. HPT 372 RAID Management Software Installation Guide for Windows® 2000

In order to enable the on-screen monitoring function displaying disk array device information, you may install the “HPT 37X RAID Administrator” onto your system. The main features of this administrator are described below:

1. It can let you monitor the status of HDDs that are connected on HPT 372 controller. It can show the RAID types and status on screen.
2. It can directly create any mode of the RAID function in a Windows environment, making it easier and more user friendly than creating the RAID function in BIOS mode.

Please insert the KX series CD into your CD-ROM drive. It should execute the program automatically. If not, you can go to the CD location and execute the execution file from the main directory of the CD. After it is executed, you will see the screen shot below.



Step 1: Move the cursor to “HPT 37X RAID Administrator” and click on it to go to the next step.



Step 2: The “InstallShield Wizard” shows up, and it will go to the next screen for a while.



Step 3: You will now see the welcome screen and its dialogue box. Click “Next>” to go on.

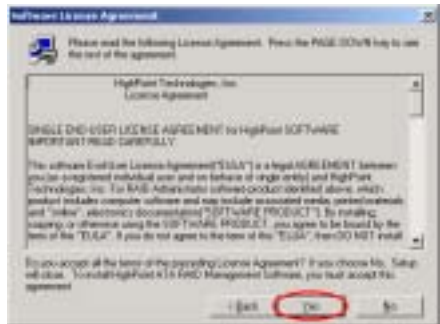

Step 4: The software license agreement screen shows up, read it and then click “Yes” to go on.



Step 5: Now you can choose the folder for the destination location you want. We suggest that you use the default folder as the destination location. When you are sure of the folder, click “**Next>**” to go on.



Step 6: Now you can select the program folder. The setup wizard will add program icons to those program folders listed. Click “**Next>**” to go on.



Step 7: The system will start copying files. You can see the percentage bar on the screen.

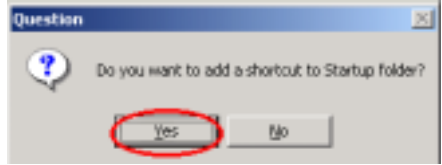

Step 8: Program ask you want to add a shortcut to startup folder or not? We suggestion you choose “**Yes**”.



Step 9: When the installation is completed, and if you don't want to lunch readme file. Click “**Finish**” to end the setup.

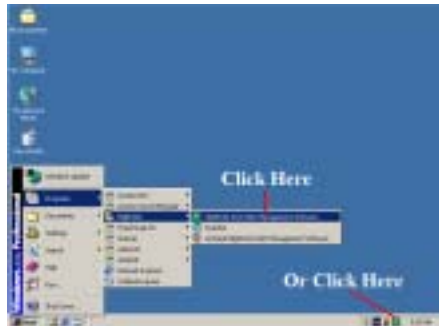

Step 10: After the system restart, you can run this “**HighPoint ATA RAID Management Software**” program show at above.



This screen show you the first screen you will see when you starting the software.



This is the “View” Menu screen.



This is the “Configuration” Menu screen.



For detailed information of this software, you can refer to the “Help” menu. It will provide you all the information of this software that you need to know.



This is the “Management” Menu screen.



Appendix A. VIA 4 in 1 Drivers Installation for Windows® 98 SE & Windows® 2000

After you've installed Windows® 98 SE or Windows® 2000, you will need to install the VIA 4 in 1 drivers. Step by step instructions on how to do this are found in the following section.

Note

After installing Windows® 98 SE & Windows® 2000, the quality of your display will be poor because it will be set to 640*480 and 16 colors. For the best screen capture quality, install the VGA drivers and set the desktop to 800*600 using True Color.

Note

Under Windows® 2000 operating system you have to install the service pack 2 (SP2) or latest service pack to get the best system performance. You can download SP2 at Microsoft® WEB site.

Note

Details of the Windows® 98 SE or Windows® 2000 operating system will not be mentioned in this manual. If you have any problems with Windows® 98 SE or Windows® 2000 installation, operations, or settings, please refer to your Windows® 98 SE or Windows® 2000 user's manual or other databases provided by Microsoft® Corporation.

Insert the KX series CD into your CD-ROM drive, it should execute the program automatically. If not, you can go to the CD location and execute the execution file at the main directory of the CD. After it has been executed you will see the screen below.



Step 1: Move the cursor to "VIA 4in1 Driver" and click on it. You will go to the next screen.



Step 2: The "InstallShield Wizard" shows up, and it will go to the next screen for a while.

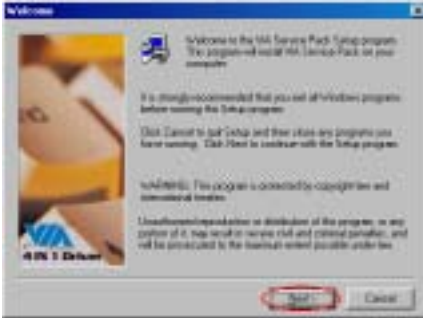

Step 3: You will now see the welcome screen and its dialogue box. Click the “**N**ext>” to go on.



Step 4: The service pack readme screen will appear. Click the “**Y**es” button to go on.



Step 5: You can choose “**N**ormally Install” or “**Q**uickly Install” to install the VIA 4-in-1 drivers. If you choose “**Q**uickly Install” mode, this driver will automatically detect and install the latest 4-in-1 drivers.

For users who are upgrading VIA Drivers, we recommend installing the 4-in-1 using the

“**Q**uickly Install” mode, as it will automatically detect and update the necessary drivers. The following step we will describe the “**N**ormally Install” mode procedure.



Step 6: This setup program will install four kinds of drivers. Please check which drivers you want to install. When you choose the items, please click the “**N**ext>” button to continue. (**Windows® 98 SE**)



Step 6: This setup program will install three kinds of drivers. Please check which drivers you want to install. When you choose the items, please click the “**N**ext>” button to continue. (**Windows® 2000**)



Step 7: Choose the “Install VIA ATAPI Vendor Support Driver” then click the “Next>” button to go on. (Windows® 98 SE)



Step 9: Choose “Install VIA AGP VxD in Turbo mode”, and then click the “Next>” button. (Windows® 98 SE)

Note: The difference between “Normal” & “Turbo” mode

Installing in “turbo” mode will give your graphics card enhanced speed and performance while “normal” mode offers increased system stability.

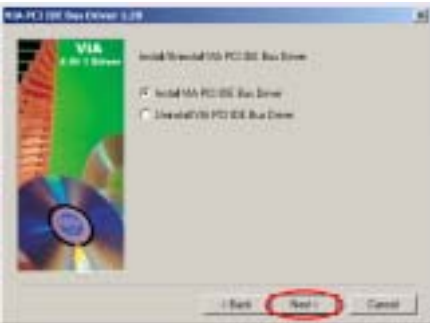

Step 7: Choose the “Install VIA PCI IDE Bus Driver” then click the “Next>” button to go on. (Windows® 2000)



Step 8: Choose “Install AGP 4X/133 Driver”, then click the “Next>” button. (Windows® 2000)



Step 8: Choose “Click to enable DMA Mode” then click “Next>” button. (Windows® 98 SE)



Step 10: Choose “**Install VIA IRX1 Routing Miniport Driver**”, and then click the “**Next>**” button. (**Windows® 98 SE**)

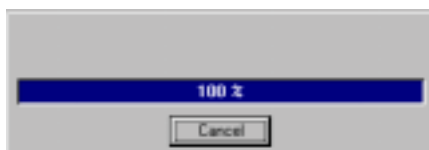

Step 11: The installer will show the install progress percentage. (**Windows® 98 SE**)

Step 9: The installer will show the install progress percentage. (**Windows® 2000**)



Step 12: When the installation is complete, the installer will ask you to restart your computer. We suggest that you choose “**Yes, I want to restart my computer now.**” then click the “**Finish**” button to restart your computer to finish the driver updates. (**Windows® 98 SE**)

Step 10: When the installation is complete, the installer will ask you to restart your computer. We suggest that you choose “**Yes, I want to restart my computer now.**” Then click the “**Finish**” button to restart your computer to finish the driver update. (**Windows® 2000**)

*** The descriptions below are all for Windows® 98 SE.**

When your computer system restarts, Windows® 98 SE starts the update process and several new hardware devices will be found and updated. When restarting Windows® 98 SE, the CD-ROM drives will fail to be found in the updating process. If the prompt dialogue box asks you to put the Windows® 98 SE CD into the CD-ROM drive, just ignore this message and let it go to the next process.

Step 13: You can then check the “System Properties” see that the devices are properly installed. (Windows® 98 SE)

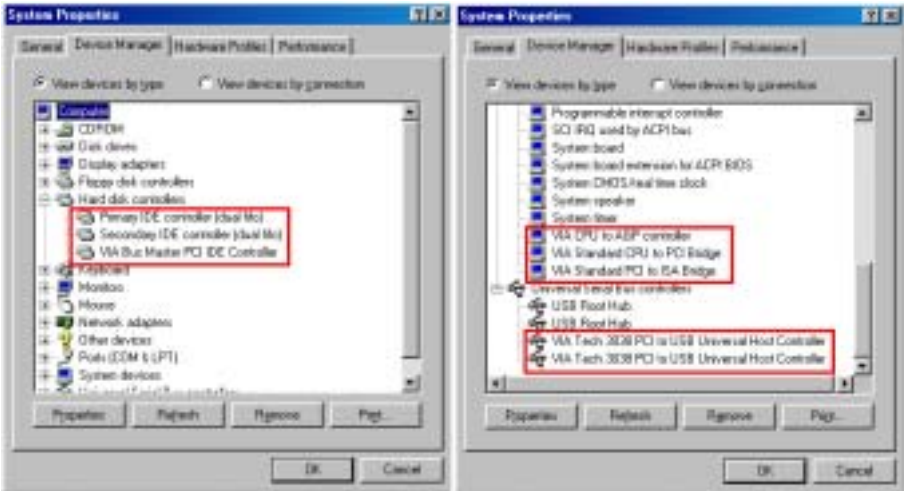

Step 11: You can then check the “Device Manager” to see that the devices are properly installed. (Windows® 2000)

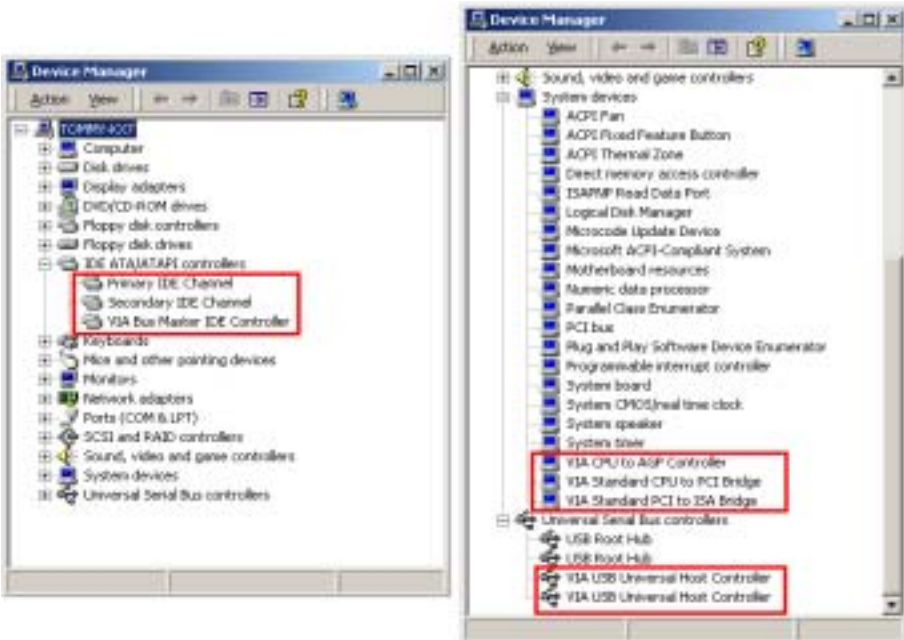



Appendix B. Installing The Hardware Monitor System

The Hardware Monitor System is a self-diagnostic system for PCs. It will protect PC hardware by monitoring several critical items including power supply voltage, CPU and system fan speeds, and CPU and system temperatures. These items are important for the operation of the system; errors may result in permanent damage to the PC. Once any item is out of its normal range, a warning message will pop up and remind the user to take proper measures.

The following description will tell you how to install the Hardware Monitor System and use it. Insert the KX series CD into your CD-ROM drive. It should execute the program automatically. If not, you can go to the CD location and execute the execution file from the main directory of this CD. After it is executed, you will see the screen below.



Click “Utility” button.



Click “Hardware Monitor” button to start install the hardware monitor system utility.



Then wizard will extract the files need to install.



You will see the install shell wizard active.

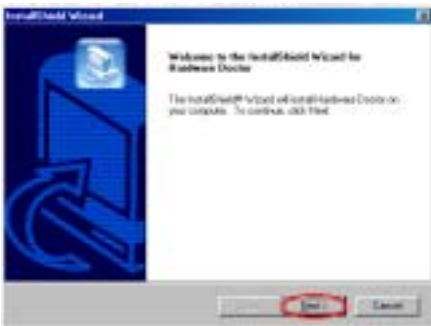

The welcome screen and its dialogue box will appear. Click the "Next" button to go on.



Now you can choose the destination location where you want to install the drivers. We suggest that you use the default folder as the destination location. After checking the folder click “**Next>**” button.



You can choose the name of the program folder. We suggest you use the default program folder name. After checking the program folder name then click “**Next>**” button.

Program will start to install drivers the system needs.

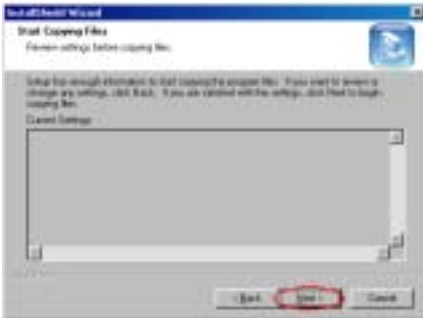

The wizard will prepare to start install the program file.

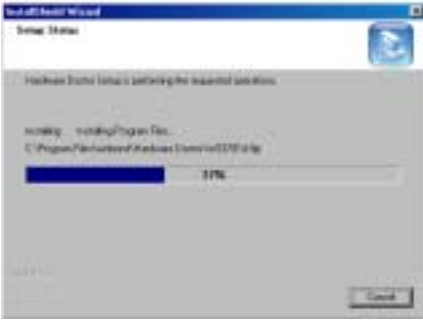

The installer will show the install progress percentage.



When the installation is complete, the installer will ask you to restart your computer. We suggest that you choose “**Yes, I want to restart my computer now.**” then click the “**Finish**” button to restart your computer to finish the driver update.

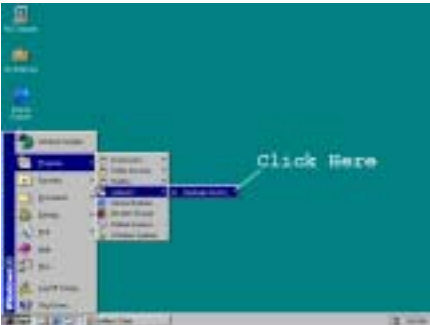

You can select the program from Start toolbar, and then choose Programs. You will see the item called “**Winbond**” → “**Hardware Doctor**”. Click it, and you will be able to see the screen below.

This screen shows the hardware monitor system screen. It shows information about system temperature, voltages and fan speed. Some items can let you set the warning range; you can optimize values by setting them in accordance your system.

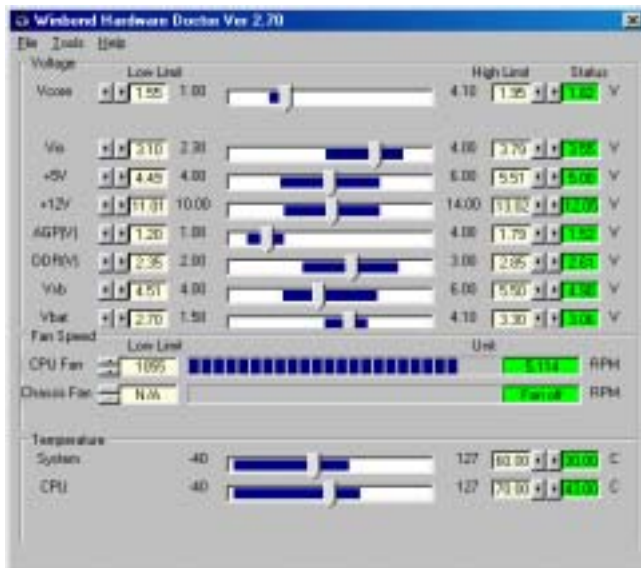



Appendix C. BIOS Update Guide

We will use the SE6 motherboard as an example. All other models follow the same process. (The motherboard photo we show you below is SX7-533)

1. Know your motherboard's PCB version number. You can find it at the front or back of the motherboard. Each motherboard always has the label (Bar code sticker) at a different place on the PCB to show the PCB version. (As shown in the photo below, just for example)



2. Know the current BIOS ID.



For example, in this case, the current BIOS ID is “00”. If you already have the latest BIOS, no any update action is necessary. If your BIOS is not the latest BIOS, go on to the next step.

3. Download the correct BIOS file from our Web site.

You can click the “**Download**” button on the green line, then go to our download center and choose the correct BIOS file and download it.



4. Double click the download file-it will self-extract to awdf flash.exe and .bin files.

5. Make a bootable floppy disk and copy the necessary files onto it.



You may make a floppy disk bootable either in Explorer or in the DOS prompt mode.

```
[c:\]>format a: /s
```

After formatting and transferring the system to the floppy disk, copy two files into it. One is the BIOS flash utility “awdf^lash.exe” and the other is the decompressed BIOS “.bin” file.

6. Boot off floppy disk.

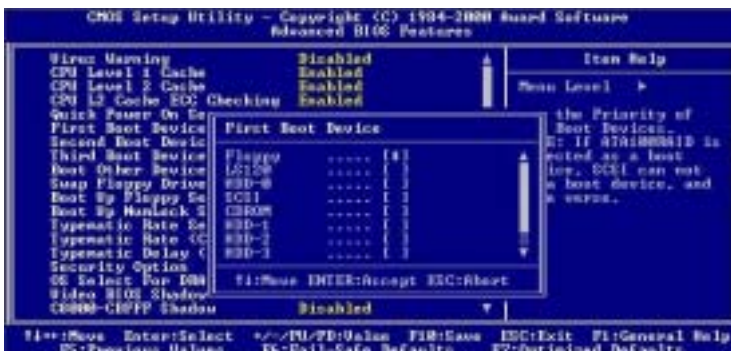

Please set the first boot sequence as “**floppy**” in BIOS and boot off the floppy disk.

7. Flash the BIOS in pure DOS mode.

```
A:\>awdf flash se6_sw.bin /cc /cd /cp /py /sn /cks /r_
```

After successfully booting off of the floppy, execute the flash utility according to these instructions.

Note

We strongly recommend you use the above parameters following “**awdf flash**” to flash your BIOS. **DO NOT** just type “**awdf flash se6_sw.bin**” without the above parameters following the .bin file.

Note

The Award flash utility can't be completed under a Windows[®] 95/98 or Windows[®] NT, Windows[®] 2000, Windows[®] XP, Windows[®] ME environment, you must be in a pure DOS environment.

You should check which BIOS file is to be used with your motherboard, don't flash with the wrong BIOS file. Otherwise, you may cause system malfunctions.

Note

Please do not use the Award flash memory writer version that earlier than Version 7.52C to flash your KX7-333/KX7-333R motherboard BIOS. Otherwise, it may cause flash fail or un-anticipate problems.

Note

During the updating, the progress will be measured by white blocks. The last four *blue* blocks of the flash update process represent the “**BIOS boot block**”. The BIOS boot block is used to prevent the BIOS from becoming corrupt during programming. It should not be programmed every time. If this “**BIOS boot block**” remains intact when the BIOS becomes corrupt during programming, then you can boot from a bootable floppy next time you boot your computer. This allows you to flash your BIOS again without the need for technical support from the dealer.

Appendix D. Troubleshooting (Need Assistance?)

Motherboard Troubleshooting:

Q & A:

Q: Do I need to clear the CMOS before I use a new motherboard to assemble my new computer system?

A: Yes, we highly recommend that you clear the CMOS before installing a new motherboard. Please move the CMOS jumper from its default 1-2 position to 2-3 for a few seconds, and then back. When you boot up your system for the first time, follow the instructions in the user's manual to load the optimized defaults.

Q: If my systems hang when I update the BIOS or set the wrong CPU parameters, what should I do?

A: Whenever you update the BIOS or if the system hangs due to wrong CPU parameters setting, always clear CMOS jumper before booting up again.

Q: How can I get a quick response to my request for technical support?

A: Be sure to follow the guidelines as stated in the "Technical Support Form" section of this manual.

If you have a problem during operation, in order to help our technical support personnel quickly determine the problem with your motherboard and give you the answers you need, before filling in the technical support form, eliminate any peripheral that is not related to the problem, and indicate it on the form. Fax this form to your dealer or to the company where you bought the hardware in order to benefit from our technical support. (You can refer to the examples given below)



Example 1: With a system including: motherboard (with processor, DDR DRAM, etc.) HDD, CD-ROM, FDD, graphic adapter, MPEG-2 card, SCSI adapter, audio card, etc. After the system is assembled, if you cannot boot up, check the key components of the system using the procedure described below. First remove all interface cards except the VGA card and try to reboot.

☛ **If you still cannot boot up:**

Try installing another brand/model VGA card and see if the system will start. If it still does not start, note the VGA card model, motherboard model, Bios identification number, CPU on the technical support form (refer to main instructions), and describe the problem in the problem description space provided.

☛ **If you can boot up:**

Insert the interface cards you have removed back into the system, one by one and try to start the system each time you insert a card, until the system will not start. Keep the VGA card and the interface card that caused the problem inserted on the motherboard, remove any other cards or peripheral, and start again. If you still cannot start, note the information related to both cards in the add-on Card space provided, and don't forget to indicate the motherboard model, version, BIOS identification number, CPU (refer to main instructions), and give a description of the problem.



Example 2: With a system including: motherboard (with processor, DDR DRAM, etc.) HDD, CD-ROM, FDD, graphic adapter, MPEG-2 card, SCSI adapter, audio card, etc. After assembly and after having installed the audio card driver, when you restart the system, when it runs the audio card driver, it resets automatically. This problem may be due to the audio card driver. During the starting DOS... procedure, press SHIFT (BY-PASS) key, to skip CONFIG.SYS and AUTOEXEC.BAT; edit CONFIG.SYS with a text editor, and in function the line that loads the audio card driver, add a remark REM, in order to disable the audio card driver. See the example below.

```
CONFIG.SYS:
DEVICE=C:\DOS\HIMEM.SYS
DEVICE=C:\DOS\EMM386.EXE HIGHSCAN
DOS=HIGH, UMB
FILES=40
BUFFERS=36
REM DEVICEHIGH=C:\PLUGPLAY\DWCFGMG.SYS
LASTDRIVE=Z
```

Restart the system. If the system starts and does not reset, you can be sure that the problem is due to the Sound Card Driver. Write down the Sound Card model, motherboard model, BIOS identification number on the technical support file (refer to main instructions), and describe the problem in the space provided.

☺☺☺ We will show you how to fill the “**Technical Support Form**”.

🌀 Instructions 🌀

To fill in this “**Technical Support Form**”, refer to the step-by-step instructions given below:

- 1* **Model Name:** Note the model number given in your user’s manual.
For example: KX7-333, KX7-333R, SD7-533, KR7A, KR7A-RAID, etc.
- 2* **Motherboard PCB Version:** Note the motherboard PCB version labeled on the motherboard slot or back side as “**Rev: *.***”.
For example: REV: 1.01
- 3* **BIOS ID & Part Number:** See *Appendix C* for detailed information.
4. **DriverVersion:** Note the driver version number indicated on the device driver disk or CD-ROM (if have) as “**Release *.***” (or Rev. *.* , Version *.*). For example:

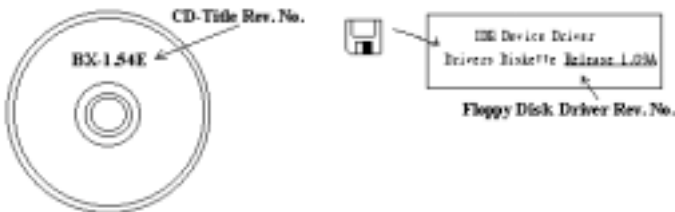

-
- 5* **OS/Applications:** Indicate the operating system and the applications you are running on the system.
For example: Windows® 98 SE, Windows® 2000, Windows® XP, etc.
- 6* **Processor Type:** Indicate the brand and the speed (MHz) of your CPU.
Example: (A) In the “**Brand**” space, write “**AMD**”, in the “**Specifications**” space, write “**Athlon™ 1 GHz**”.
7. **Hard Disk Drive:** Indicate the brand and specifications of your HDD(s), specify if the HDD is using IDE1 or IDE2. If you know the disk capacity, indicate it and check (“✓”) “”; in case you give no indication, we will consider that your HDD is “ IDE1” Master.
For example: In the “**Hard Disk Drive**” space, check the box, in the “**Brand**” space, write “**SEAGATE**”, in the “**Specifications**” space, write “**Darracuda ATA2 ST330631A (30 GB)**”.
8. **CD-ROM Drive:** Indicate the brand and specifications of your CD-ROM drive. Specify if it uses IDE1 or IDE2, and check (“✓”) “”; in case you give no indication, we will consider that your CD-ROM is “ IDE2” Master.
For example: In the “**CD-ROM Drive**” space, check the box, in the “**Brand**” space, write “**Pioneer**”, in the “**Specifications**” space, write “**DVD-16**”.
9. **System Memory (DDR SDRAM):** Indicate the brand and specifications (DDR DIMM) of your system memory. Examples: Density, Description, Module Components, Module Part Number, CAS Latency, Speed (MHz). For example:
In the “**Brand**” space, write “**Micron**”, in the “**Specifications**” space, write:
Density: 128 MB, **Description:** SS 16 Megx72 2.5V ECC Gold, **Module Components:** (9) 16 Megx 8, **Module Part Number:** MT9VDDT1672AG, **CAS Latency:** 2, **Speed (MHz):** 200 MHz.
Please give us the detailed information of your DDR DIMM module, as it will help us to simulate the problems you met.
10. **Add-On Card:** Indicate which add-on cards you are *absolutely sure* are related to the problem.
If you can’t identify the problem’s origin, indicate all the add-on cards inserted into your system. Remember to identify which card insert on which slot.
For example: Creative SB Value sound card insert on PCI slot 3.
11. **Problem Description:** Please tell us problem you met. The more detailed, the better as our engineers can help to find the solution more quickly. If the problem is random occurrence, it may be hard to simulate the problem and may take more time to find a solution.

Note

Items between the “*” are absolutely necessary.

RAID Troubleshooting

Q & A:

Q: May I use hard drives with different capacity or transfer mode?

A: In order to get optimized performance, we suggest using hard drives with the same model.

Q: How to assign a booting device?

A: You may press <Ctrl> <H> to assign a booting device in RAID BIOS (See Chapter 4 for detailed information).

Q: Why can't I see correct capacity in FDISK utility?

A: This is a well-known issue of Windows® 95/98's FDISK utility. If an IBM 75GB hard disk DTLA 307075 only gets 7768MB in Windows® 95/98's FDISK utility, please contact Microsoft® for a latest version of FDISK utility. For windows® 2000, there is no such a 64GB issue.

<http://www.storage.ibm.com/techsup/hddtech/welcome.htm>

Q: How to create a striping and mirror array (RAID 0+1)?

A: You need four HDD drives, every two of them on the same channel/cable build a striping array. Then create a mirror array by these two striping arrays (See Chapter 4 for detailed information).

1. Press <Ctrl> <H> to setup configuration
2. Choose item 1 to Create RAID.
3. Choose item 1 to set Array Mode as Striping and Mirror (RAID 0+1).
4. Choose item 2 to Select Disk Drives. There are two striping arrays built automatically and you only have to enter twice.
5. Choose item 4 to Start Creation Process.
6. Press <Esc> to finish setting and leave RAID BIOS.

Q: How to rebuild a mirror array when one of the drives corrupts?

A: You need to delete previous array setting, duplicate the data, then rebuild a new array setting (See Chapter 4 for detailed information).

1. Press <Ctrl> <H> to setup configuration
2. Choose item 2 to Delete Array.
3. Choose item 3 to Rebuild Mirror Array.
4. Choose sub item 1 to Select Source Disk, the one with data on it.
5. Choose sub item 2 to Select Target Disk, the brand new and empty one.
6. Choose sub item 3 to Start Duplication Process.
7. After duplication process completes, press <Esc> to leave RAID BIOS.

Q: Why I see “NO ROM BASIC SYSTEM HALTED” when booting?

A: There isn't any activated primary partition in you system. Please use FDISK or any other utilities to create/set one.

Do & Don't:

1. **Do** always use the same model drives to achieve best quality and performance. Different firmware has different timing characteristic, thus may somewhat decrease the RAID performance.
2. If you have two drives, do connect them on two different channels as master drive please.
3. When attach drives to the RAID card, do make sure the master/slave jumper settings are correct please. If there is only one drive on one channel/cable, do set it as master or single drive.
4. **Do** always use 80 conductor cables please.
5. **Don't** connect any ATAPI devices (CD-ROM, LS-120, MO, ZIP etc.) on the RAID card please.
6. For the best performance result, please do use the Ultra DMA 66/100/133 Hard Disks.



Appendix E. How to Get Technical Support

(From our website) <http://www.abit.com.tw>

(In North America) <http://www.abit-usa.com>

(In Europe) <http://www.abit.nl>

Thank you for choosing ABIT products. ABIT sells all our products through distributors, resellers and system integrators, we have no direct sales to end-users. Before sending email for tech support please check with your resellers or integrators if you need any services, they are the ones who sold you your system and they should know best as to what can be done, how they serve you is a good reference for future purchases.

We appreciate every customer and would like to provide the best service to you. Providing fast service to our customers is our top priority. However we receive many phone calls and a huge amount of email from all over the world. At the present time it is impossible for us to respond to every single inquiry. Therefore it is quite possible that if you send an email to us that you may not receive a response.

We have done many compatibility tests and reliability tests to make sure our products have the best quality and compatibility. In case you need service or technical support, please understand the constraint we have and **always check with the reseller who sold the product to you first.**

To expedite service, we recommend that you follow the procedures outlined below before contacting us. With your help, we can meet our commitment to provide the best service to the **greatest number of ABIT customers:**

1. **Check the Manual.** It sounds simple, but we have taken a lot of care in making a well-written and thorough manual. It is full of information that doesn't only pertain to motherboards. The CD-ROM included with your board will have the manual as well as drivers. If you don't have either one, go to the Program Download Area of our website or FTP server.
2. **Download latest BIOS, software or drivers.** Please go to our Program Download area on our website to check to see if you have the latest BIOS. They are developed over periods of time to fix bugs or incompatibilities. **Also please make sure you have the latest drivers from your peripheral cards makers!**
3. **Check the ABIT Technical Terms Guide and FAQ on our website.** We are trying to expand and make the FAQs more helpful and information rich. Let us know if you have any suggestions. For hot topics check out our HOT FAQ!
4. **Internet Newsgroups.** They are a great source of information and many people there can offer help. ABIT's Internet News group, **alt.comp.peripherals.mainboard.abit**, is an ideal forum for the public to exchange information and discuss experiences they have had with ABIT products. Many times you will see that your question has already been asked before. This is a public Internet news group and it is reserved for free discussions, Here is a list of some of the more popular ones:

alt.comp.peripherals.mainboard.abit

comp.sys.ibm.pc.hardware.chips

alt.comp.hardware.overclocking

alt.comp.hardware.homebuilt

alt.comp.hardware.pc-homebuilt

Ask your reseller. Your ABIT authorized distributor should be able to provide the fastest solution to your technical problem. We sell our products through distributors who sell to resellers and stores. Your reseller should be very familiar with your system configuration and should be able to solve your problem much more efficiently than we could. After all, your reseller regards you as an important

customer who may purchase more products and who can urge your friends to buy from him or her as well. They integrated and sold the system to you. They should know best what your system configuration is and your problem. They should have reasonable return or refund policies. How they serve you is also a good reference for your next purchase.

- 5. Contacting ABIT.** If you feel that you need to contact ABIT directly you can send email to the ABIT technical support department. First, please contact the support team for the branch office closest to you. They will be more familiar with local conditions and problems and will have better insight as to which resellers offer what products and services. Due to the huge number of emails coming in every day and other reasons, such as the time required for problem reproduction, we will not be able to reply to every email. Please understand that we are selling through distribution channels and don't have the resources to serve every end-user. However, we will try to do our best to help every customer. Please also remember that for many of our technical support team English is a second language, you will have a better chance of getting a helpful answer if your question can be understood in the first place. Be sure to use very, simple, concise language that clearly states the problem, avoid rambling or flowery language and always list your system components. Here is the contact information for our branch offices:

**In North America and South America please contact:
ABIT Computer (USA) Corporation**

46808 Lakeview Blvd.
Fremont, California 94538, U.S.A.
sales@abit-usa.com
technical@abit-usa.com
Tel: 1-510-623-0500
Fax: 1-510-623-1092

**In the UK and Ireland:
ABIT Computer Corporation Ltd.**

Unit 3, 24-26 Boulton Road
Stevenage, Herts
SG1 4QX, UK
abituksales@compuserve.com
abituktech@compuserve.com
Tel: 44-1438-228888
Fax: 44-1438-226333

**In Germany and Benelux (Belgium, Netherlands, Luxembourg) countries:
AMOR Computer B.V. (ABIT's European Office)**

Van Coehoornstraat 7,
5916 PH Venlo, The Netherlands
sales@abit.nl
technical@abit.nl
Tel: 31-77-3204428
Fax: 31-77-3204420

All other territories not covered above please contact:

Taiwan Head Office

When contacting our headquarters please note we are located in Taiwan and we are 8+ GMT time. In addition, we have holidays that may be different from those in your country.

ABIT Computer Corporation

No. 323, YangGuang St., Neihu, Taipei, 114, Taiwan

sales@abit.com.tw

market@abit.com.tw

technical@abit.com.tw

Tel: 886-2-87518888

Fax: 886-2-87513381

RMA Service. If your system has been working but it just stopped, but you have not installed any new software or hardware recently, it is likely that you have a defective component. Please contact the reseller from whom you bought the product. You should be able to get RMA service there.

- 6. Reporting Compatibility Problems to ABIT.** Because of tremendous number of email messages we receive every day, we are forced to give greater weight to certain types of messages than to others. For this reason, any compatibility problem that is reported to us, giving detailed system configuration information and error symptoms, will receive the highest priority. For the other questions, we regret that we may not be able to reply directly. But your questions may be posted to the internet news group in order that a larger number of users can have the benefit of the information. Please check the news group from time to time.
- 7.** Listed below are some chipset vendors' WEB site addresses for your reference:

ALi's WEB site: <http://www.ali.com.tw/>

AMD's WEB site: <http://www.amd.com/>

Highpoint Technology Inc.'s WEB site: <http://www.highpoint-tech.com/>

Intel's WEB site: <http://www.intel.com/>

SiS' WEB site: <http://www.sis.com.tw/>

VIA's WEB site: <http://www.via.com.tw/>

Thank you, ABIT Computer Corporation

<http://www.abit.com.tw>

