Federal Communications Commission (F.C.C) Statement

This device complies with Part 15 of the FCC Rules. Operation of this device is subject to the following two conditions: (1) this device may not cause harmful interference, and (2) this device must accept any interference received, including interference that may cause undesired operation.

Accessories: This device has been tested and found to comply with the limits of a Class B digital device, the accessories associated with this equipment are as follows:

1. Shielded serial cable. (Can be obtained from multiple retail outlets)
2. Shielded printer cable. (Can be obtained from multiple retail outlets)
3. Shielded video cable. (Can be obtained from multiple retail outlets)
4. Shielded power cord. (Provided by manufacturer)

These accessories are required to be used in order to ensure compliance with FCC Rules. It is the responsibility of the user to provide and use these accessories properly.

This equipment has been tested and found to comply with the limits of a Class B digital device, pursuant to Part 15 of the FCC Rules. These limits are designed to provide reasonable protection against harmful interference in a residential installation. This equipment generates, uses and can radiate radio frequency energy and, if not installed and used in accordance with the instructions, may cause harmful interference to radio communications. However, there is no guarantee that interference will not occur in a particular installation. If this equipment does cause harmful interference to radio or television reception, which can be determined by turning the equipment off and on, the user is encouraged to try to correct the interference by one or more of the following measures:

1. Reorient / Relocate the receiving antenna.
 2. Increase the separation between the equipment and receiver.
 3. Connect the equipment into an outlet on a circuit different from that to which the receiver is connected.
 4. Consult the dealer or an experienced radio/TV technician for help.
-

Caution: Changes or modifications not expressly approved by the manufacturer could void the user's authority to operate the equipment.

Disclaimer

The Vendor makes no representations or warranties with respect to the contents hereof and specially disclaims any implied warranties of merchantability or fitness for any purpose. Further the Vendor reserves the right to revise this publication and to make changes from time to time in the contents hereof without obligation to notify any party beforehand.

Duplication of this publication, in part or in whole, is not allowed without first obtaining the Vendor's approval in writing.

Trademarks and Remarks

MS-DOS, Windows, Windows NT, and Windows 9X are products of Microsoft Corp, with its ownership of trademark, and are distributed by the Vendor under a license agreement.

All trademarks used in this manual are the property of their respective owners.

Copyright(C) 1992
All Rights Reserved

Canadian D.O.C. Statement

This digital apparatus does not exceed the Class B limits for radio noise emissions from digital apparatus as set out in the radio interference regulations of the Canadian Department of Communications.

And

Le present appareil numerique n'emet pas de bruits radioelectriques depassant les limites appliques aux appareils numeriques de Class B prescripts Dan le regalement usr le brouillage radioelectrique edict par le minister Des Communications du Canada.

Contents

Introduction	1-1
1 Motherboard Description	1-2
1.1 Features	1-2
1.1.1 Hardware	1-2
1.1.2 Software	1-4
1.1.3 Attachments	1-4
1.2 Motherboard Installation	1-5
1.2.1 Layout of Motherboard	1-5
1.3 Motherboard Connectors	1-6
1.3.1 Front Panel Connectors (J11)	1-6
1.3.2 Back Panel Connectors	1-7
1.4 CPU Installation/Jumper Setting	1-8
1.4.1 CPU Installation Procedure	1-8
1.4.2 CPU Voltage Selection (JP1 / JP11)	1-9
1.4.3 CPU Clock Selection (JP2)	1-11
1.5 Jumper Settings	1-17
1.5.1 CMOS Function Selection (JP4)	1-17
1.5.2 CPU Cooling Fan Power Connector (J1)	1-19
1.5.3 Wake-On-LAN Header (JP6)	1-20
1.5.4 Wake-On-Internal Modem (JP5)	1-21
1.6 DRAM Installation	1-22
1.6.1 DIMM	1-22

Contents

1.6.2 How to install a DIMM Module.....	1-23
2. BIOS Setup.....	2-1
2.1 Main Menu.....	2-3
2.2 Standard CMOS Setup Menu.....	2-5
2.3 BIOS Features Setup.....	2-10
2.4 Chipset Features Setup.....	2-16
2.5 Power Management Setup.....	2-20
2.6 PNP / PCI Configuration Setup.....	2-24
2.7 Load Setup Defaults.....	2-27
2.8 Integrated Peripherals Setup	2-28
2.9 Supervisor / User Password Setting	2-32
2.10 IDE HDD Auto Detection.....	2-34
2.11 Save & Exit Setup.....	2-35
2.12 Exit Without Saving.....	2-36
2.13 Application Software	2-37
2.14 IDE Driver Setup	2-38
2.15 AGP Driver Setup	2-41
2.15.1 System requirements Windows 95:	2-41
2.15.2 Installation Instructions Windows 95:.....	2-41
2.15.3 Uninstallation Instructions Windows 95 and.....	2-42
2.16 Serial and Parallel Interface ports	2-43
3. Trouble Shooting	3-1

Introduction

System Overview

Thanks for buying this product! This manual was written to help you start using this product as quickly and smoothly as possible. Inside you will find adequate explanations to solve most problems. In order for this reference material to be of greatest use, refer to the “expanded table of contents” to find relevant topics.

This board incorporates the system board, ISA I/O, and PCI IDE into one board that provides a total PC solution. The motherboard, a Pentium™ microprocessor based PC/AT system, supports a 512KB cache with ISA Bus and PCI Local Bus to support upgrades to your system performance. It is ideal for multi-tasking and fully supports MS-DOS, Windows, Windows NT, Novell, OS/2, Windows9x, UNIX, SCO UNIX etc. This manual also explains how to install the motherboard for operation and how to setup your CMOS configuration with the BIOS setup program.

1 Motherboard Description

1.1 Features

1.1.1 Hardware

CPU

- Pentium™ processor P54C/CT/CS/CQS, MMX™; Cyrix6x86™ 6x86/6x86MII processor; AMD-K5™ /AMD-K6™ / AMD-K6™ -2 processor; idt Win™ Chip /idtWin™ Chip-2 processor .
- Provides 321-pin ZIF socket (socket 7).

Speed

- Supports CPU bus clock 60/66/75/83/95/100 MHz.
- supports 30/33 MHz PCI Bus speed.
(when processors running at 75/83/95/100MHz, the clock generator will be divided it by 2.5 or 3 which makes PCI bus speed become 33 MHz respectively)
- I/O clock 8 MHz for ISA Bus.
- Supports 60/66 MHz AGP Bus speed.

DRAM Memory

- Supports 168-pin DIMM module sockets.
- Supports DRAM memory 8MB to 384MB on board.
- Supports Symmetrical DRAM.
- Supports 3 banks DIMM, 3.3V Unbuffered Synchronous DRAM.

Cache Memory

- Supports 512K Pipelined Burst SRAM.

Flash Memory

- Supports PnP function for better system compatibility.
- Allows you to easily upgrade system BIOS.

Shadow RAM

- A memory controller that provides shadow RAM and supports 8-bit ROM BIOS.

Green Function

- Supports power management operation via BIOS.
- Power down timer from 1 Min to 1 Hour.
- Wakes up by any key press or mouse activity.
- Ringins resume on internal / external modem supported.
- Power-On by keyboard or PS/2 mouse (optional).

BUS Slots

- Provides two 16-bit ISA Bus slots.
- Four 32-bit PCI Bus Master slots.
- One AGP slot.

PCI Enhanced IDE Built-in On Board

- Supports 4 IDE hard disk drives.
- Supports Ultra DMA/33, Bus Master Mode.
- Supports IDE interface with CD-ROM.
- Supports high capacity hard disk drives.
- Supports LBA mode.
- Supports PIO modes up to Mode 4 Timings, and Multiword DMA Mode 0,1,2 with Independent Timing of up to 4 Drives.
- Supports booting from LS-120 "Super Disk" or Iomega ZIP 100MB disk.

ISA I/O Built-in Onboard

- Supports one multi-mode Parallel Port:
 - (1) Standard & Bidirection Parallel Port (SPP).
 - (2) Enhanced Parallel Port (EPP).
 - (3) Extended Capabilities Port (ECP).
- Supports two serial ports, 16550 UART with 16 byte FIFO.

- Supports one Infrared transmission (IR) port.
- Supports PS/2 Mouse , PS/2 Keyboard.
- Supports 360KB, 720KB, 1.2MB, 1.44MB and 2.88MB floppy disk drives.

Universal Serial Bus

- Supports two Universal Serial Bus (U.S.B) Ports.
- Supports 48MHz USB.

Platform

- ATX.

Dimension

- 20 cm X 30.5 cm (W x L)

1.1.2 Software**BIOS**

- AWARD legal friendly BIOS.
- Supports PnP functions.

Operating System

- Offers the highest performance for MS-DOS, OS/2, Windows, Windows NT, Windows 9x, Novell, UNIX, SCO UNIX etc.

1.1.3 Attachments

- HDD Cable
- FDD Cable
- Flash Memory Writer for BIOS Update (optional)
- IDE Driver & AGP Driver
- Back I/O Panel for ATX case. (optional)

1.2 Motherboard Installation

1.2.1 Layout of Motherboard

Model No.M5ALA Ver:2.0

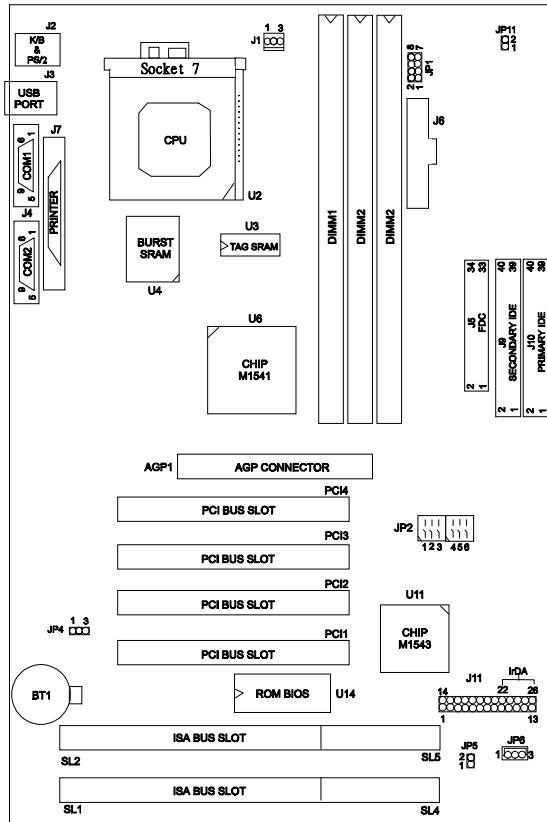

1.3 Motherboard Connectors

1.3.1 Front Panel Connectors (J11)

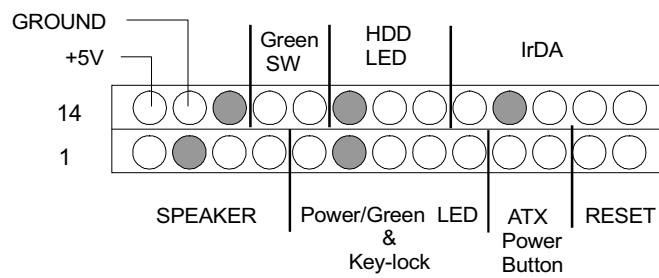

Pin No.	Assignment	Function	Pin No.	Assignment	Function
1	Speaker	Speaker Connector	14	+5V	VCC
2	NC		15	Ground	Ground
3	Ground		16	No Connection	NC
4	+5V		17	Green Control	Green
5	Power LED(+)	Power/Green LED & Keylock	18	Ground	Switch
6	No Connection		19	No Connection	NC
7	LED(-)		20	HDD LED(-)	HDD
8	Key lock		21	HDD LED(+)	LED
9	Ground	ATX Power Button	22	+5V	IrDA Connector
10	Power Switch		23	No Connection	
11	Standby Voltage		24	IRRX	
12	Reset Control		25	Ground	
13	Ground		26	IRTX	

1.3.2 Back Panel Connectors

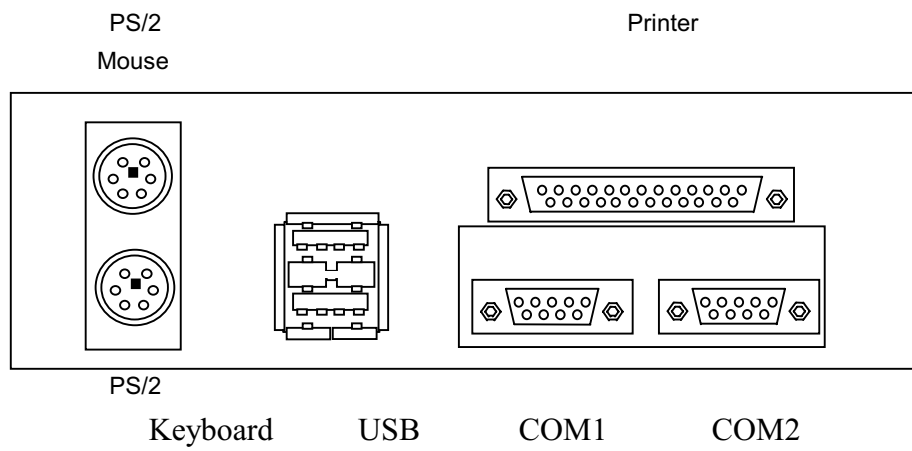

1.4 CPU Installation/Jumper Setting

1.4.1 CPU Installation Procedure

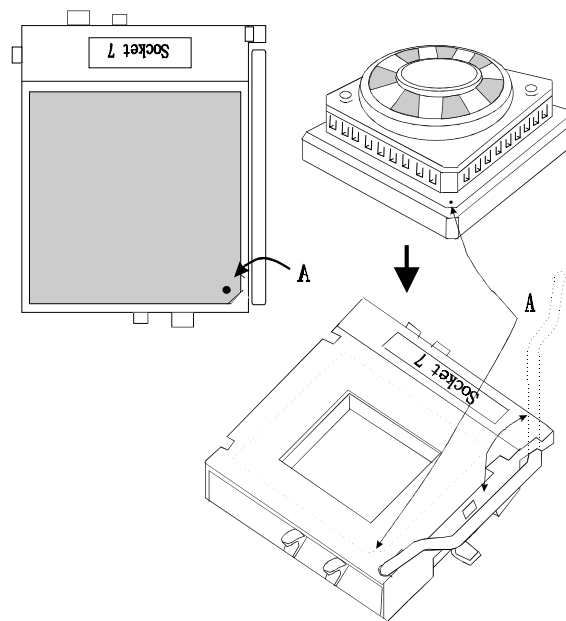

1. Pull the lever sideways away from the socket then raise the lever up to a 90-degree angle.
2. Locate Pin A in the socket and look for the white dot or cut edge in the CPU. Match Pin A with the white dot/cut edge then insert the CPU.
3. Press the lever down to complete the installation.

1.4.2 CPU Voltage Selection (JP1/JP11)

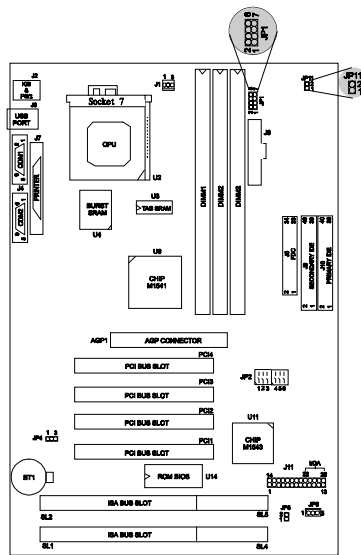

CPU TYPE	CPU Voltage		JP1	JP11
	CORE	I / O		
Single Voltage INTEL™ P54C/CQS/CT Cyrix™ 6x86 AMD™ K5 idt Win™ Chip	3.5V	3.5V	1-2 closed 3-4 closed 5-6 closed 7-8 closed	open

CPU TYPE	CPU Voltage		JP1	JP11
	CORE	I / O		
Dual Voltage				
INTEL™ P55C/MMX™	2.1V	3.3V	1-2 closed 3-4 open 5-6 open 7-8 open	open
	2.2V	3.3V	1-2 open 3-4 closed 5-6 open 7-8 open	open
Cyrix™ 6x86L/6x86MII	2.8V	3.3V	1-2 open 3-4 open 5-6 open 7-8 closed	open
	2.9V	3.3V	1-2 closed 3-4 open 5-6 open 7-8 closed	open
AMD™ K6 / K6 -2	3.2V	3.3V	1-2 open 3-4 open 5-6 closed 7-8 closed	open
	3.3V	3.3V	1-2 closed 3-4 open 5-6 closed 7-8 closed	open
	2.2V	3.45V	1-2 open 3-4 closed 5-6 open 7-8 open	closed
	2.7V	3.3V	1-2 closed 3-4 closed 5-6 closed 7-8 open	open

1.4.3 CPU Clock Selection (JP2)

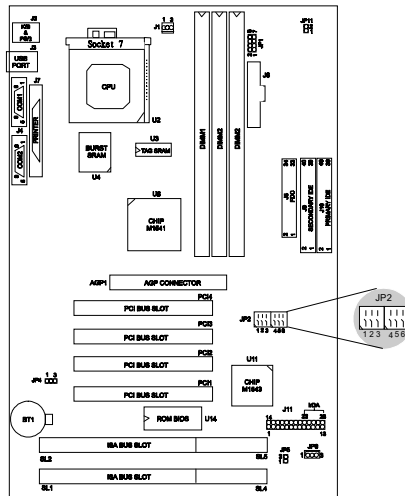

(a) CPU Bus Clock and Multiplier Selection

JP2(1) ON & JP2(2) ON & JP2(3) ON	:Bus Clock = 60MHz
JP2(1) OFF & JP2(2) ON & JP2(3) ON	:Bus Clock = 66MHz
JP2(1) ON & JP2(2) ON & JP2(3) OFF	:Bus Clock = 75MHz
JP2(1) OFF & JP2(2) ON & JP2(3) OFF	:Bus Clock = 83MHz
JP2(1) ON & JP2(2) OFF & JP2(3) OFF	:Bus Clock = 95MHz
JP2(1) OFF & JP2(2) OFF & JP2(3) OFF	:Bus Clock = 100MHz
JP2(4) ON & JP2(5) OFF & JP2(6) OFF	: Multiplier = 2
JP2(4) ON & JP2(5) ON & JP2(6) OFF	: Multiplier = 2.5
JP2(4) OFF & JP2(5) ON & JP2(6) OFF	: Multiplier = 3
JP2(4) OFF & JP2(5) OFF & JP2(6) OFF	: Multiplier = 3.5
JP2(4) ON & JP2(5) OFF & JP2(6) ON	: Multiplier = 4
JP2(4) ON & JP2(5) ON & JP2(6) ON	: Multiplier = 4.5
JP2(4) OFF & JP2(5) ON & JP2(6) ON	: Multiplier = 5

(b) INTEL CPU

CPU Speed	Bus Clock & Multiplier	JP2(1)	JP2(2)	JP2(3)	JP2(4)	JP2(5)	JP2(6)
120MH	60MHz x 2	ON	ON	ON	ON	OFF	OFF
133MH	66MHz x 2	OFF	ON	ON	ON	OFF	OFF
150MH	60MHz x 2.5	ON	ON	ON	ON	ON	OFF
166MH	66MHz x 2.5	OFF	ON	ON	ON	ON	OFF
200MH	66MHz x 3	OFF	ON	ON	OFF	ON	OFF
233MH	66MHz x 3.5	OFF	ON	ON	OFF	OFF	OFF
266MH	66MHz x 4	OFF	ON	ON	ON	OFF	ON

(c) AMD-K5™ CPU

CPU Speed	JP2 (1)	JP2 (2)	JP2 (3)	JP2 (4)	JP2 (5)	JP2 (6)
PR-120	ON	ON	ON	ON	OFF	OFF
PR-133	OFF	ON	ON	ON	OFF	OFF
PR-166	OFF	ON	ON	ON	ON	OFF
PR-200	OFF	ON	ON	OFF	ON	OFF

(d) AMD-K6™ CPU

CPU Speed	Bus Clock & Multiplier	JP2 (1)	JP2 (2)	JP2 (3)	JP2 (4)	JP2 (5)	JP2 (6)
166MHz	66MHz x 2.5	OFF	ON	ON	ON	ON	OFF
200MHz	66MHz x 3	OFF	ON	ON	OFF	ON	OFF
233MHz	66MHz x 3.5	OFF	ON	ON	OFF	OFF	OFF
266MHz	66MHz x 4	OFF	ON	ON	ON	OFF	ON
300MHz	66MHz x 4.5	OFF	ON	ON	ON	ON	ON

(e) AMD-K6™ -2 CPU

CPU Speed	Bus Clock & Multiplier	JP2 (1)	JP2 (2)	JP2 (3)	JP2 (4)	JP2 (5)	JP2 (6)
250MHz	100 x 2.5	OFF	OFF	OFF	ON	ON	OFF
300MHz	100 x 3	OFF	OFF	OFF	OFF	ON	OFF
333MHz	66 x 5	OFF	ON	ON	OFF	ON	ON
333MHz	95 x 3.5	ON	OFF	OFF	OFF	OFF	OFF
350MHz	100 x 3.5	OFF	OFF	OFF	OFF	OFF	OFF

(f) Cyrix 6x86™ / 6x86L™ CPU

CPU Speed	Bus Clock & Multiplier	JP2(1)	JP2(2)	JP2(3)	JP2(4)	JP2(5)	JP2(6)
PR-150+ 120MHz	60MHz x 2	ON	ON	ON	ON	OFF	OFF
PR-166+ 133MHz	66MHz x 2	OFF	ON	ON	ON	OFF	OFF
PR-200+ 150MHz	75MHz x 2	ON	ON	OFF	ON	OFF	OFF

(g) Cyrix 6x86MII™ CPU

CPU Speed	Bus Clock & Multiplier	JP2 (1)	JP2 (2)	JP2 (3)	JP2 (4)	JP2 (5)	JP2 (6)
PR-150+ 120MHz	60MHz x 2	ON	ON	ON	ON	OFF	OFF
PR-166+ 133MHz	66MHz x 2	OFF	ON	ON	ON	OFF	OFF
PR-166+ 150MHz	60MHz x 2.5	ON	ON	ON	ON	ON	OFF
PR-200+ 150MHz	75MHz x 2	ON	ON	OFF	ON	OFF	OFF
PR-200+ 166MHz	66MHz x 2.5	OFF	ON	ON	ON	ON	OFF
PR-233+ 166MHz	83MHz x 2	OFF	ON	OFF	ON	OFF	OFF
PR-200+ 180MHz	60MHz x 3	ON	ON	ON	OFF	ON	OFF
PR-233+ 188MHz	75MHz x 2.5	ON	ON	OFF	ON	ON	OFF
PR-233+ 200MHz	66MHz x 3	OFF	ON	ON	OFF	ON	OFF
PR-266+ 208MHz	83MHz x 2.5	OFF	ON	OFF	ON	ON	OFF
PR-300+ 225MHz	75MHz x 3	ON	ON	OFF	OFF	ON	OFF
PR-300+ 233MHz	66MHz x 3.5	OFF	ON	ON	OFF	OFF	OFF
PR-333+ 263MHz	75MHz x 3.5	ON	ON	OFF	OFF	OFF	OFF

(h) idt-Win™ Chip CPU

CPU Speed	Bus Clock & Multiplier	JP2 (1)	JP2 (2)	JP2 (3)	JP2 (4)	JP2 (5)	JP2 (6)
180MHz	60MHz x 3	ON	ON	ON	OFF	ON	OFF
200MHz	66MHz x 3	OFF	ON	ON	OFF	ON	OFF

(i) idt-Win™ Chip CPU WINCHIP2



CPU Speed	Bus Clock & Multiplier	JP2 (1)	JP2 (2)	JP2 (3)	JP2 (4)	JP2 (5)	JP2 (6)
200MHz	66MHz x 3	OFF	ON	ON	OFF	ON	OFF

1.5 Jumper Settings

A jumper is two or more pins which may be covered by a plastic jumper cap, allowing you to select different system options.

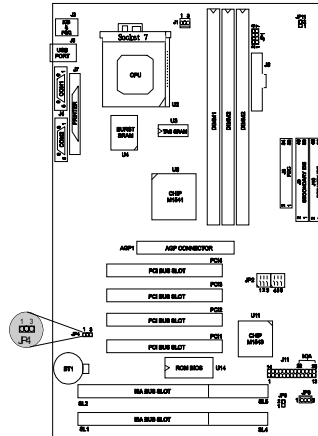
1.5.1 CMOS Function Selection (JP4)

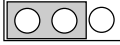

JP4	Assignment
1 3  1-2 Closed	Normal Operation
1 3  2-3 Closed	Clear CMOS Data
1 3  Open	Onboard Battery Disabled

Note : Please follow the procedure as below to clear BIOS Password if your password is lost or forgotten.

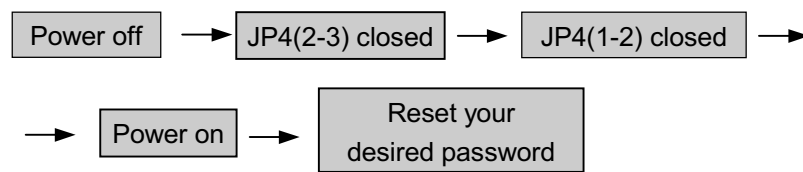

1.5.2 CPU Cooling Fan Power Connector (J1)

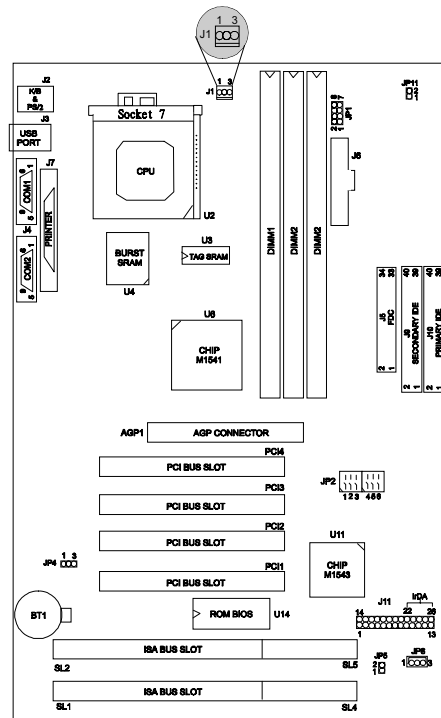

Pin No.	Assignment
1	Control
2	+12 V
3	GND

1.5.3 Wake-On-LAN Header (JP6)

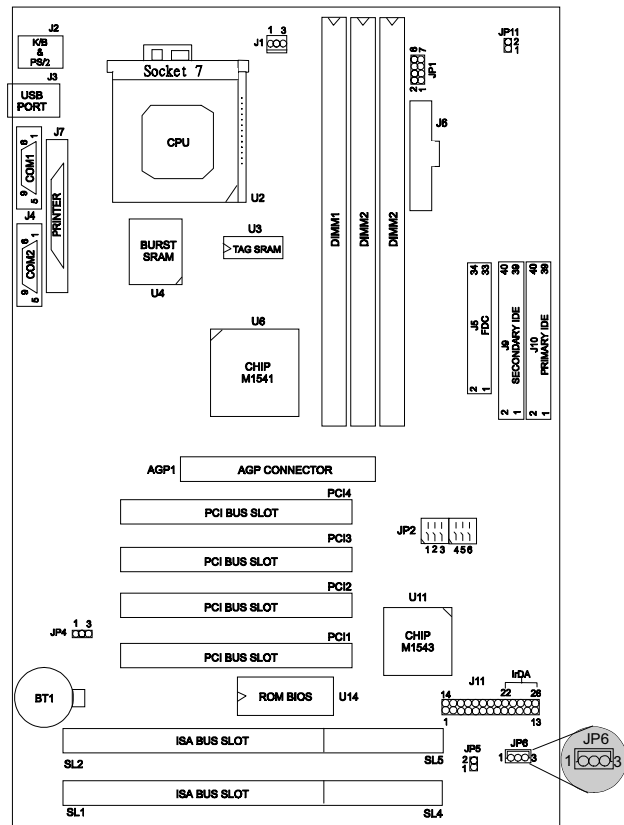

Pin No.	Assignment
1	+5 VSB
2	Ground
3	MP-Wakeup

1.5.4 Wake-On-Internal Modem (JP5)

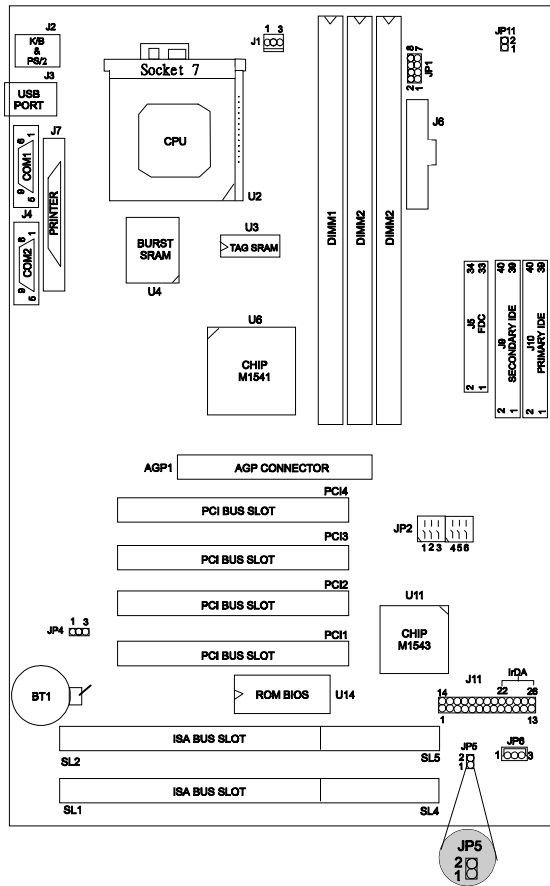

Pin No.	Assignment
1	Wakeup signal
2	GND

1.6 DRAM Installation

1.6.1 DIMM

DRAM Access Time : 3.3V Unbuffered SDRAM 15ns required.

DRAM Type : 8MB/16MB/32MB/64MB DIMM Module (168pin)

Total Memory Size	Bank 0	Bank 1	Bank 2
	DIMM 1	DIMM 2	DIMM 3
8M	8M x 1 pc	----	----
16M	16M x 1 pc	----	----
32M	32M x 1 pc	----	----
64M	64M x 1 pc	----	----
128M	128M x 1 pc	----	----
24M	8M x 1 pc	8M x 1 pc	8M x 1 pc
32M	16M x 1 pc	8M x 1 pc	8M x 1 pc
48M	32M x 1 pc	8M x 1 pc	8M x 1 pc
80M	64M x 1 pc	8M x 1 pc	8M x 1 pc
40M	8M x 1 pc	16M x 1 pc	16M x 1 pc
48M	16M x 1 pc	16M x 1 pc	16M x 1 pc
64M	32M x 1 pc	16M x 1 pc	16M x 1 pc
96M	64M x 1 pc	16M x 1 pc	16M x 1 pc
72M	8M x 1 pc	32M x 1 pc	32M x 1 pc
80M	16M x 1 pc	32M x 1 pc	32M x 1 pc
96M	32M x 1 pc	32M x 1 pc	32M x 1 pc
128M	64M x 1 pc	32M x 1 pc	32M x 1 pc
136M	8M x 1 pc	64M x 1 pc	64M x 1 pc
144M	16M x 1 pc	64M x 1 pc	64M x 1 pc
160M	32M x 1 pc	64M x 1 pc	64M x 1 pc
192M	64M x 1 pc	64M x 1 pc	64M x 1 pc
384M	128M x 1 pc	128M x 1 pc	128M x 1 pc

**Each Bank can be installed and used individually. The mainboard provides optimal performance and free choices depending on your needs.*

**The list show above for DRAM configuration is just for reference.*

When processor running at 100MHz, PC-100 SDRAM is necessary.

When processor running at 100MHz, the memory for SDRAM only.

1.6.2 How to install a DIMM Module

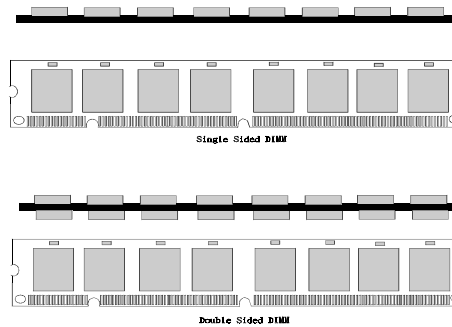

4. The DIMM slot has a “*Plastic Safety Tab*” and the DIMM memory module has an “asymmetrical notch”, so the DIMM memory module can only fit in one direction.
5. Push the tabs out. Insert the DIMM memory modules into the socket at 90-degree angle, then push down vertically so that it will fit into place.
6. The Mounting Holes and plastic tabs should fit over the edge and hold the DIMM memory modules in place.

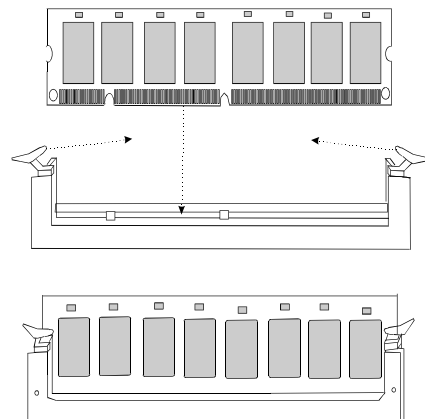

2. BIOS Setup

Entering Setup

Power on the computer and press immediately allowing you to enter Setup. The other way to enter Setup is to power on the Computer, and when the message below appears briefly at the bottom of the screen during the POST (Power On Self Test), press the key or simultaneously press the <CTRL>, <Alt>, and <Esc> keys.

TO ENTER SETUP BEFORE BOOT PRESS CTRL-ALT-ESC OR DEL KEY

If the message disappears before you respond and you still wish to enter Setup, restart the system again by turning it OFF then ON or pressing the "RESET" button on the system case. You may also restart by simultaneously pressing the < CTRL>, <Alt>, and <Delete> keys. If you do not press the keys at the correct time and the system does not boot, an error message will be displayed, and you will again be asked to:

PRESS F1 TO CONTINUE, CTRL-ALT-ESC OR DEL TO ENTER SETUP

Main Menu

The on line description of the highlighted setup function is displayed at the bottom of the screen.

Status Page Setup Menu/Option Page Setup Menu

Press <F1> to pop up a small help window that describes the appropriate keys to use and the possible selections for the highlighted item. To exit the Help Window Press <Esc>.

Control Keys

Up arrow	Move to previous item
Down arrow	Move to next item
Left arrow	Move to the item at left
Right arrow	Move to the item at right
Esc key	Main Menu:make a space Quit and do not save changes into CMOS Status Page Setup Menu and Option Page Setup Menu: Exit current page and return to Main Menu
PgUp key	Increase the numeric value or make changes
PgDn key	Decrease the numeric value or make changes
+ key	Increase the numeric value or make changes
- key	Decrease the numeric value or make changes
F1 key	General help, only for Status Page Setup Menu and Option Page Setup Menu
(Shift) F2 key	Change color to one of 16 colors. F2 to select color forward, (Shift) F2 to select color backward
F3 key	Reserved
F4 key	Reserved
F5 key	Restore the previous CMOS value, only for Option Page Setup Menu
F6 key	Load the default CMOS value from BIOS default table, only for Option Page Setup Menu
F7 key	Load the default
F8 key	Reserved
F9 key	Reserved
F10 key	Save all the CMOS changes, only for Main Menu

2.1 Main Menu

Once you enter AWARD BIOS CMOS Setup Utility, the Main Menu(**Figure 1**) will appear on the screen. The Main Menu allows you to select an item and press <Enter> to accept or enter its sub-menu.

■ **Figure 1. Main Menu**

ROM PCI/ISA BIOS (xxxxxxx)
CMOS SETUP UTILITY
AWARD SOFTWARE, INC.

STANDARD CMOS SETUP	INTEGRATED PERIPHERALS
BIOS FEATURES SETUP	SUPERVISOR PASSWORD
CHIPSET FEATURES SETUP	USER PASSWORD
POWER MANAGEMENT SETUP	IDE HDD AUTO DETECTION
PNP / PCI CONFIGURATION	SAVE & EXIT SETUP
LOAD SETUP DEFAULTS	EXIT WITHOUT SAVING
Esc : Quit	↑ ↓ → ← : Select Item
F10 : Save & Exit Setup	(Shift) F2 : Change Color
Time, Date, Hard Disk Type...	

Standard CMOS Setup

This setup page includes all the items in a standard compatible BIOS.

BIOS Features Setup

This setup page includes all the items for the BIOS special enhanced features.

Chipset Features Setup

This setup page includes all the items for chipset special features.

Power Management Setup

This setup page includes all the items for power management features.

PnP / PCI Configuration

This category specifies the value (in units of PCI bus clocks) of the latency timer for this PCI bus master and the IRQ level for PCI device.

Load Setup Defaults

Chipset defaults indicates the values required by the system for maximum performance. The OEM manufacturer may change to defaults through MODBIN before the binary image burn into the ROM.

Integrated Peripherals

This setup page includes all the items for Integrated Peripherals features.

Supervisor Password / User Password Setting

Change, set, or disable password. It allows you to limit access to the system and Setup, or just to Setup.

IDE HDD Auto Detection

Automatically configure hard disk parameters.

Save & Exit Setup

Save CMOS value changes to CMOS and exit setup.

Exit Without Saving

Abandon all CMOS value changes and exit setup.

2.2 Standard CMOS Setup Menu

The items in the Standard CMOS Setup Menu are divided into categories. Each category includes no, one, or more than one setup item. Use the arrow keys to highlight the item and then use the <PgUp> or <PgDn> keys to select the value you want in each item.

■ Figure 2. Standard CMOS Setup Menu

ROM PCI/ISA BIOS (xxxxxxxx)
STANDARD CMOS SETUP
AWARD SOFTWARE, INC.

Date (mm:dd:yy) : Mon, Aug 3 1998										
Time (hh:mm:ss) : 11 : 37 : 30										
HARD DISKS										
	TYPE	SIZE	CYLS	HEAD	PRECOMP	LANDS	SECTOR	MODE		
Primary Master	: Auto	0	0	0	0	0	0	Auto		
Primary Slave	: Auto	0	0	0	0	0	0	Auto		
Secondary Master	: Auto	0	0	0	0	0	0	Auto		
Secondary Slave	: Auto	0	0	0	0	0	0	Auto		
Drive A	:1.44MB, 3.5 in.									
Drive B	:None									
Video	:EGA/VGA									
Halt On	:All, But Keyboard									
Base Memory		:								0K
Extended Memory		:								0K
Other Memory		:								512K
Total Memory		:								512K
Esc : Quit ↑ ↓ → ← : Select Item PU/PD/+/-:Modify										
F1 : Help (Shift) F2 : Change Color										

Date

The Date format is **<day><month><date><year>**.

Day	The day, from Sun to Sat, is determined by the BIOS and is display-only
Date	The date, from 1 to 31 (or the maximum allowed in the month)
month	The month, Jan through Dec
year	The year, from 1994 through 2079

Time

The time format is **<hour><minute><second>**. The time is calculated based on the 24-hour military-time clock. For example, 2 p.m. is 14:00:00.

Hard Disk Type

This categories identifies the types of hard disk(s) that have been installed in the computer. There are 46 predefined types and a user definable type. Type 1 to Type 45 are predefined. Type "User" is user-definable. Type "Auto" is automatically defined by BIOS.

Press **<PgUp>** or **<PgDn>** to select a numbered hard disk type or type the number and press **<Enter>**. Note that the specifications of your drive must match with the drive table. The hard disk will not work properly if you enter improper information for this category. If your hard disk drive type is not listed, you can use Type "User" to define your own drive type manually.

If you select type "User", related information is asked to be entered for several items. Enter the information directly from the keyboard and press **<Enter>**. This information should be provided in the documentation from your hard disk vendor or the system manufacturer. Most new drives will also have the parameters given on the label on top of the drive.

CYLN	number of cylinders
HEAD	number of heads
WPCOM	write precompensation
SEC	number of sectors
LBA MODE	type of LBA mode
BLK MODE	type of Block mode
PIO MODE	type of PIO
32BIT MODE	type of 32-Bit transfer mode

If a hard disk has not been installed select "NOT Installed" and press <Enter>.

Drive A Type/Drive B Type

The category identifies the types of floppy disk drive A / drive B that have been installed in the computer.

None	No floppy drive installed
360K, 5 1/4	5-1/4 inch PC-type standard drive; 360 kilobyte capacity
1.2M, 5 1/4	5-1/4 inch AT-type high-density drive; 1.2 megabyte capacity
720K, 3 1/2	3-1/2 inch double-sided drive; 720 kilobyte capacity
1.44M, 3 1/2	3-1/2 inch double-sided drive; 1.44 megabyte capacity
2.88M, 3 1/2	3-1/2 inch double-sided drive; 2.88 megabyte capacity

Video

This category selects the type of adapter used for the primary system monitor, and must match your video display card and monitor. Although secondary monitors are supported, you do not have to select the type in Setup.

EGA/VGA	Enhanced Graphics Adapter/Video Graphics Array. For
----------------	-----------------------------------------------------

	EGA, VGA, SEGA, or PGA monitor adapters.
CGA 40	Color Graphics Adapter, power up in 40 column mode
CGA 80	Color Graphics Adapter, power up in 80 column mode
MONO	Monochrome adapter, includes high resolution monochrome adapters

Halt On

The category determines whether the computer will stop if an error is detected during power up.

No errors	Whenever the BIOS detects a non-fatal error the system will be stopped and you will be prompted.
All errors	The system boot will not stop for any error that may be detected.
All, But Keyboard	The system boot will not stop for a keyboard error, it will stop for all other errors.
All, But Diskette	The system boot will not stop for a disk error, it will stop for all other errors.
All, But Disk/Key	The system boot will not stop for a keyboard or disk error, it will stop for all other errors.

Memory

This category is display-only which is determined by POST (Power On Self Test) of the BIOS.

Base Memory

The POST of the BIOS will determine the amount of base (or conventional) memory installed in the system. The value of the base memory is typically 512K for system with 512K memory installed on the motherboard, or 640K for system with 640K or more memory installed on the motherboard.

Extended Memory

The BIOS determines how much extended memory is present during the POST. This is the amount of memory located above 1MB in the CPU's memory address map.

Other Memory

This refers to the memory located in the 640K address space. This is the memory that can be used for different applications. DOS uses this area to load device drivers to keep as much base memory free application programs. The most common use for this area is Shadow RAM.

2.3 BIOS Features Setup

!! WARNING !! The information about BIOS defaults in the manual (Figure 3.4.5.6.8) is just for reference, please refer to the BIOS installed on board, for update information.

■ **Figure 3. BIOS Features Setup Menu**

ROM PCI/ISA BIOS (xxxxxxxx)
 BIOS FEATURES SETUP
 AWARD SOFTWARE, INC.

Virus Warning	: Disabled	Video BIOS Shadow	: Enabled
CPU Internal Cache	: Enabled	C8000-CBFFF Shadow	: Disabled
External Cache	: Enabled	CC000-CFFFF Shadow	: Disabled
Quick Power On Self Test	: Enabled	D0000-D3FFF Shadow	: Disabled
Boot From LAN First	: Disabled	D4000-D7FFF Shadow	: Disabled
Boot Sequence	: A,C,SCSI	D8000-DBFFF Shadow	: Disabled
Swap Floppy Drive	: Disabled	DC000-DFFFF Shadow	: Disabled
Boot Up Floppy Seek	: Enabled		
Boot Up NumLock Status	: On		
Gate A20 Option	: Fast		
Typematic Rate Setting	: Disabled		
Typematic Rate (Chars/Sec)	: 6		
Typematic Delay (Msec)	: 250		
Security Option	: Setup		
Init AGP Display First	: Enabled	ESC : Quit	↑ ↓ → ← : Select Item
PCI/VGA Palette Snoop	: Disabled	F1 : Help	PU/PD/+/- : Modify
OS Select For DRAM > 64MB	: Non-OS2	F5 : Old Values	<Shift> F2 : Color
Report No FDD For WIN 95	: No	F7 : Load Setup Defaults	

Virus Warning

This category flashes on the screen. During and after the system boot up, any attempt to write to the boot sector or partition table of the hard disk drive will halt the system and an error message will appear. In the mean time, you can run an anti-virus program to locate the problem.

Disabled (default)

No warning message to appear when anything attempts to access the boot sector or hard disk partition table.

Enabled

Activates automatically when the system boots up causing a warning message to appear when anything attempts to access the boot sector of hard disk partition table.

CPU Internal Cache

Enabled (default) Enable cache
Disabled Disable cache

External Cache

Cache memory is additional memory that is much faster than conventional DRAM (system memory). Most, but not all, modern PCs have additional (external) cache memory. When the CPU requests data, the system transfers the requested data from the main DRAM into cache memory, for even faster access by the CPU.

Enabled (default) Enable cache
Disabled Disable cache

Quick Power On Self Test

This option enables the level 2 external cache memory.

Enabled Enable quick POST
Disabled (default) Normal POST

Boot Sequence

This option determines which drive the computer searches the OS at boot-up. The settings are "A, C, SCSI", "C, A, SCSI", "C, CDROM, A", "CDROM, C, A", "D, A, SCSI", "E, A, SCSI", "F, A, SCSI", "SCSI, A, C", "SCSI, C, A" or "C only", etc. **The default is "A, C, SCSI".**

Swap Floppy Drive

Switches the floppy disk drive between being designated as A and B. **Default is Disabled.**

Boot Up Floppy Seek

During POST, BIOS will determine if the floppy disk drive installed is 40 or 80 tracks. 360K type is 40 tracks while 720K, 1.2M, and 1.44M are all 80 tracks.

Enabled (default) BIOS searches for the floppy disk drive to determine if it is 40 or 80 tracks. Note that BIOS cannot tell from 720K, 1.2M or 1.44M drive type as they are all 80 tracks.

Disabled BIOS will not search for the type of floppy disk drive by track number. Note that there will not be any warning message if the drive installed is 360K.

Boot Up NumLock Status

On (default)	Numpad is number keys.
Off	Numpad is arrow keys.

Gate A20 Option

Gate A20 refers to the way the system addresses memory above 1MB (extended memory). When set to Fast, the system chipset controls Gate A20. When set to Normal, a pin in the keyboard controller controls Gate A20. Setting Gate A20 to Fast improves system speed, particularly with OS/2 and Windows.

Fast (default)

Typematic Rate Setting

This determines the typematic rate.

Enabled	Enable typematic rate and typematic delay programming.
Disabled (default)	Disable typematic rate and typematic delay programming. The system BIOS will use default value of these 2 items and the default is controlled by keyboard.

Typematic Rate (Chars/Sec)

6	6 characters per second
8	8 characters per second
10	10 characters per second
12	12 characters per second
15	15 characters per second
20	20 characters per second
24	24 characters per second
30	30 characters per second

Typematic Delay (Msec)

Choose the length of delay from the time you press a key and the character repeating. (units are mil-sec)

Security Option

This category allows you to limit access to the system and Setup, or just to Setup.

System

The system will not boot and access to Setup will be denied if the correct password is not entered at the prompt.

Setup (default)

The system will boot, but access to Setup will be denied if the correct password is not entered at the prompt.

PCI / VGA Palette Snoop

Choose Disabled or Enabled. Some graphic controllers which are not VGA compatible take the output from a VGA controller and map it to their display as a way to provide boot information and VGA compatibility.

However, the color information coming from the VGA controller is drawn from the palette table inside the VGA controller to generate the proper colors, and the graphic controller needs to know what is in the palette of the VGA controller. To do this, the non-VGA graphic controller watches for the Write access to the VGA palette and registers the snoop data. In PCI based systems, where the VGA controller is on the PCI bus and a non-VGA graphic controller is on an ISA bus, the Write Access to the palette will not show up on the ISA bus if the PCI VGA controller responds to the Write.

In this case, the PCI VGA controller should not respond to the Write, it should only snoop the data and permit the access to be forwarded to the ISA bus. The non-VGA ISA graphic controller can then snoop the data on the ISA bus. Unless you have the above situation, you should disable this option.

Disabled (default)	Disables the function.
Enabled	Enables the function.

OS Selection for DRAM > 64MB

Allows OS/2 to be used with > 64MB of DRAM. Settings are Non-OS/2 (default) and OS/2. Set to OS/2 if using more than 64MB and running OS/2.

DEFAULT is Non-OS2.

Video BIOS Shadow

Determines whether video BIOS will be copied to RAM for faster execution.

Enabled	Optional ROM is enabled.
Disabled (default)	Optional ROM is disabled.

C8000 - CFFFF Shadow / E8000 - EFFFF Shadow

Determines whether the optional ROM will be copied to RAM for faster execution.

Enabled	Optional ROM is shadowed.
Disabled (default)	Optional ROM is not shadowed.

Note : For C8000 - DFFFF option - ROM on PCI BIOS, BIOS will automatically enable the shadow RAM.

User does not have to select the item.

2.4 Chipset Features Setup

The Chipset Features Setup option is used to change the values of the chipset registers. These registers control most of the system options in the computer.

■ Figure 4. Chipset Feature Setup Menu

ROM PCI/ISA BIOS (xxxxxxx)
 CHIPSET FEATURES SETUP
 AWARD SOFTWARE, INC.

Auto Configuration	: Enabled	
AT Bus Clock	: CLK 2/4	
DRAM Timing	: Normal	
SDRAM CAS Latency	: Auto	
Pipelined Function	: Enabled	
Graphics Aperture Size	: 64MB	
SDRAM Burst X-1-1-1-1-1-1	: Enabled	
DRAM Data Integrity Mode	: Disabled	
Memory Hole At 15M-16M	: Disabled	
Host Read DRAM Command Mode	: By pass	
ISA Line Buffer	: Enabled	
Passive Release	: Enabled	
Delay Transaction	: Disabled	
Primary Frame Buffer	: ALL	
VGA Frame Buffer	: Enabled	
Data Merge	: Disabled	
		ESC : Quit ↑↓ → ← : Select Item
		F1 : Help PU/PD/+/- : Modify
		F5 : Old Values <Shift> F2 : Color
		F7 : Load Setup Defaults

Auto Configuration

Choosing **Enabled** (default) will automatically configure chipset features using default settings. Choose Disable to customize setup.

AT Bus Clock

You can set the speed of the AT bus in terms of a fraction of the CPU clock speed, or at the fixed speed of 7.16MHz.

CLK 2/4 (default)

DRAM Timing

The value in this field depends on performance parameters of the installed memory chips (DRAM). Do not change the value from the factory setting unless you install new memory that has a different performance rating from the original DRAMs.

Normal (default)

SDRAM CAS Latency

When synchronous DRAM is installed, the number of clock cycles of CAS latency depends on the DRAM timing. Do not reset this field from the default value specified by the system designer.

Auto (default)

Pipelined Function

When Enabled, the controller signals the CPU for a new memory address before all data transfers for the current cycles are complete, resulting in faster performance.

Enabled (default)

Graphics Aperture Size

Select the size of Accelerated Graphics Port (AGP) aperture. The aperture is a portion of the PCI memory address range dedicated

for graphics memory address space. Host cycles that hit the aperture range are forwarded to the AGP without any translation.

64MB (default)
4M, 8M, 16M, 32M, 128M, 256M

DRAM Data Integrity Mode

Select Parity or ECC (error-correcting code), according to the type of installed DRAM.

Disabled (default)

Memory Hole At 15M-16M

You can reserve this area of system memory for ISA adapter ROM. When this area is reserved, it cannot be cached. The user information of peripherals that need to use this area of system memory usually discusses their memory requirements.

Disabled (default)

ISA Line Buffer

The PCI to ISA Bridge has an 8-byte bi-directional line buffer for ISA or DMA bus master memory reads from or writes to the PCI bus. When Enabled., an ISA or DMA bus master can prefetch two doublewords to the line buffer for a read cycle.

Enabled (default)

Passive Release

When Enabled, CPU to PCI bus accesses is allowed during passive release. Otherwise, the arbiter only accepts another PCI master access to local DRAM.

Enabled (default)

Delay Transaction

The chipset has an embedded 32-bit posted write buffer to support delay transactions cycles. Select Enabled to support compliance with PCI specification version 2.1.

Disabled (default)

Primary Frame Buffer

Select a size for the PCI frame buffer. The size of the buffer should not impinge on local memory.

2 MB (default)

VGA Frame Buffer

When Enabled, a fixed VGA frame buffer from A000h to BFFFh and a CPU-to-PCI write buffer are implemented.

Enabled (default)

Data Merge

This field controls the data-merge feature for frame buffer cycles. When Enabled, the controller checks the eight CPU data Enable signals to determine if data bytes read from the PCI bus by the CPU can be merged.

Disabled (default)

2.5 Power Management Setup

■ Figure 5. Power Management Setup Menu

ROM PCI/ISA BIOS (xxxxxxx)
POWER MANAGEMENT SETUP
AWARD SOFTWARE, INC.

Power Management : Disabled	** PM Events **
PM Control by APM : Yes	Bus Master : Disabled
MODEM Use IRQ : 3	Primary HDD : Disabled
Video Off Option : Suspend -> Off	Secondary HDD : Disabled
Video Off Method : DPMS Support	Video I / O : Disabled
	Floppy : Disabled
** PM Monitor **	COM Ports : Enabled
HDD Power Down : Disabled	Keyboard : Enabled
Doze Mode : Disabled	LPT Ports : Disabled
Standby Mode : Disabled	
Suspend Mode : Disabled	
Power Button : Install-off	
PWR On by Ring : Disabled	
PWR On by Alarm : Disabled	
	ESC : Quit ↑ ↓ → ← : Select Item
	F1 : Help PU/PD/+/- : Modify
	F5 : Old Values <Shift> F2 : Color
	F7 : Load Setup Defaults

Power Management

Disable (Min. Saving) Global Power Management will be disabled.

User Define Users can configure their own

	power management.
(Max. Saving)	
Min Saving	Pre-defined timer values are used such that all timers are at their MAX value.
Max Saving	Pre-defined timer values are used such that all timers are at their MIN value.

PM Control by APM

No	System BIOS will ignore APM when Power Management is on.
Yes	System BIOS will wait for APM's prompt before it enters any PM mode.

MODEM Use IRQ

Set the interrupt request (IRQ) line assigned to the modem (if any) on your system. Activity of the selected IRQ always awakens the system.

3 (default)

Video Off Option

Selects the power-saving modes during which the monitor goes blank:

Always On	Monitor remains on during power-saving modes.
Suspend → Off (default)	Select this option if your monitor supports the Display Power Management Signaling (DPMS) standard of the Video Electronics Standards Association (VESA). Use the software supplied for your

Blank Screen

video subsystem to select video power management values. System only writes blanks to the video buffer.

Video Off Method**Blank Screen**

The system BIOS will only blank the screen when disabling video.

V/H SYNC+Blank

In addition to the above, BIOS will also turn off the V-SYNC & H-SYNC signals from VGA card to monitor.

DPMS

This function is enabled only for a VGA card supporting DPMS.

HDD Power Down

After the selected period of drive inactivity, the hard disk drive powers down while all other devices remain active.

Disabled (default)

Doze Mode

This option specifies how long the CPU is continuously idle before entering the doze mode. When the system is in Doze mode, the screen will be blank.

Standby Mode

After selected period of system inactivity, the fixed disk drive and video shut-off while all other devices still operate at full speed.

Disabled (default)

Suspend Mode

This options allows the user to indicate how long the system will be idle before entering the suspend mode, which turns off the CPU and saves the energy of the system.

Power Button

This item allows you to set the “off-function” of the power button by software control. The default : Delay 4 Sec, Instant Off.

Instant Off (default)

PWR On by Ring

An input signal on the serial Ring Indicator (RI) line (in other words, an incoming call on the modem) awakens the system from a soft off state.

Disabled (default)

PWR On by Alarm

When set to Enabled RTA Alarm Resume, you can set the date (of month) and timer (hh:mm:ss), to any date occurring, at which a system that has been powered down will awaken.

Disabled (default)

2.6 PNP / PCI Configuration Setup

■ Figure 6. PNP / PCI Configuration Setup Menu

ROM PCI/ISA BIOS (xxxxxxx)
 PNP / PCI FUNCTION SETUP
 AWARD SOFTWARE, INC.

PNP OS Installed : No Resources Controlled BY : Manual Reset Configuration Data : Disabled IRQ-3 assigned to : PCI / ISA PnP IRQ-4 assigned to : PCI / ISA PnP IRQ-5 assigned to : PCI / ISA PnP IRQ-7 assigned to : PCI / ISA PnP IRQ-9 assigned to : PCI / ISA PnP IRQ-10 assigned to : PCI / ISA PnP IRQ-11 assigned to : PCI / ISA PnP IRQ-12 assigned to : PCI / ISA PnP IRQ-14 assigned to : PCI / ISA PnP IRQ-15 assigned to : PCI / ISA PnP DMA-0 assigned to : PCI / ISA PnP DMA-1 assigned to : PCI / ISA PnP DMA-3 assigned to : PCI / ISA PnP DMA-5 assigned to : PCI / ISA PnP DMA-6 assigned to : PCI / ISA PnP DMA-7 assigned to : PCI / ISA PnP	Assign IRQ For VGA : Enabled ESC : Quit ↑↓ → ← : Select Item F1 : Help PU/PD/+/- : Modify F5 : Old Values <Shift> F2 : Color F7 : Load Setup Defaults
----------------------------------------------------------------------------------------------------------------------------------------------------------------------------------------------------------------------------------------------------------------------------------------------------------------------------------------------------------------------------------------------------------------------------------------------------------------------------------------------------------------------------------------------------------------------------------------------------------------------------------------------------------------------------------------------------------------------------------	----------------------------------------------------------------------------------------------------------------------------------------------------------------------------------------------------------------------------

PnP OS Installed

When set to YES, BIOS will only initialize the PnP cards used for booting (VGA, IDE, SCSI). The rest of the cards will be initialized by the PnP operating system like Windows™95. When set to NO, BIOS will initialize all the PnP cards. Therefore for non-PnP operating system (DOS, Netware™), this option must set to "NO".

Resources Controlled By “Auto” or “Manual”

By Choosing “Auto” the system BIOS will detect the system resource and automatically assign the relative IRQ and DMA channel for each peripheral.

By Choosing “Manual”(default), the user will need to assign IRQ & DMA for add-on cards. Be sure that there are no IRQ/DMA and I/O ports conflict.

Resources Configuration Data

The system BIOS supports the PnP feature so the system needs to record which resource is assigned and protect resources from conflict. Every peripheral device has a node which is called ESCD. This node records which resources are assigned to it. The system needs to record and update ESCD to the memory locations. These locations (4K) are reserved at the system BIOS.

If Disabled (default) is chosen, the system’s ESCD will update only when the new configuration varies from the last one.

If Enabled is chosen, the system is forced to update ESCDs and then is automatically set to the “Disabled” mode.

IRQ-3	assigned to : PCI / ISA PnP
IRQ-4	assigned to : PCI / ISA PnP
IRQ-5	assigned to : PCI / ISA PnP
IRQ-7	assigned to : PCI / ISA PnP
IRQ-9	assigned to : PCI / ISA PnP
IRQ-10	assigned to : PCI / ISA PnP
IRQ-11	assigned to : PCI / ISA PnP
IRQ-12	assigned to : PCI / ISA PnP
IRQ-14	assigned to : PCI / ISA PnP
IRQ-15	assigned to : PCI / ISA PnP
DMA-0	assigned to : PCI / ISA PnP
DMA-1	assigned to : PCI / ISA PnP
DMA-3	assigned to : PCI / ISA PnP
DMA-5	assigned to : PCI / ISA PnP
DMA-6	assigned to : PCI / ISA PnP

DMA-7 assigned to : PCI / ISA PnP

The above settings will be shown on the screen only if "Manual" is chosen for the Resources Controlled By function.

Legacy is the term which signifies that a resource is assigned to the ISA Bus and provides for non PnP ISA add-on cards. PCI / ISA PnP signifies that a resource is assigned to the PCI Bus or provides for ISA PnP add-on cards and peripherals.

2.7 Load Setup Defaults

Chipset defaults indicate the values required by the system for maximum performance.

■ **Figure 7. Load Setup Defaults Screen**

ROM PCI/ISA BIOS (xxxxxxx)
 CMOS SETUP UTILITY
 AWARD SOFTWARE, INC.

STANDARD CMOS SETUP	INTEGRATED PERIPHERALS
BIOS FEATURES SETUP	SUPERVISOR PASSWORD
CHIPSET FEATURES SETUP	USER PASSWORD
POWER MANAGEMENT SETUP	IDE HDD AUTO DETECTION
PCI & PCI CONF	SETUP
LOAD SETUP DE	SAVING
Load SETUP Defaults (Y/N) ? N	
Esc : Quit	↑ ↓ → ← : Select Item
F10 : Save & Exit Setup	(Shift) F2 : Change Color
Load SETUP Defaults except Standard CMOS SETUP	

If you wish to load the SETUP Defaults, change the prompt to <Y> and press <ENTER>.

2.8 Integrated Peripherals Setup

■ Figure 8. Integrated Peripherals Setup Menu

ROM PCI/ISA BIOS (xxxxxxx)
INTEGRATED PERIPHERALS
AWARD SOFTWARE, INC.

On-Chip Primary IDE : Enabled	Onboard FDC Controller : Enabled
Master PIO : Auto	Onboard Serial Port 1 : 3F8/IRQ4
Slave PIO : Auto	Onboard Serial Port 2 : 2F8/IRQ3
Master Ultra DMA : Auto	UR2 Mode : Normal
Slave Ultra DMA : Auto	
On-Chip Secondary IDE : Enabled	Onboard Parallel Port : 378/IRQ7
Master PIO : Auto	Parallel Port Mode : SPP
Slave PIO : Auto	
Master Ultra DMA : Auto	
Slave Ultra DMA : Auto	
IDE HDD Block Mode : Enabled	
On-Chip USB Controller : Disabled	
ESC : Quit ↑↓ → ← : Select Item F1 : Help PU/PD/+/- : Modify F5 : Old Values <Shift> F2 : Color F7 : Load Setup Defaults	

On-Chip Primary IDE / Secondary PCI IDE

The integrated peripheral controller contains an IDE interface with support for two IDE channels. Select Enabled to activate each channel separately.

Enabled (default)

IDE HDD Block Mode

Block mode is also called block transfer, multiple commands, or multiple sector read/write. If your IDE hard drive supports block mode (most new drives do), select "Enabled" for automatic detection of the optimal number of block read/write per sectors the drive can support.

Enabled (default)

Onboard FDC Controller

Enabled / Disabled The system has an onboard Super I/O chip with a FDD controller that supports 2 FDDs for 360K / 720K / 1.2M / 1.44M / 2.8M. Choose "Enabled" to use the onboard FDD controller for accessing the FDD. Otherwise choose "Disabled" to use the off-board FDD controller.

Onboard Serial Port 1

Disabled / (3F8 / IRQ4) / (2F8 / IRQ3) / (3E8 / IRQ4) / (2E8 / IRQ3)

Onboard Serial Port 2

Disabled / (3F8 / IRQ4) / (2F8 / IRQ3) / (3E8 / IRQ4) / (2E8 / IRQ3)
The system has an Onboard Super I/O chipset with 2 serial ports.
The Onboard serial ports can be selected as:

Disabled	
3F8 / IRQ4	COM1 uses IRQ4
2F8 / IRQ3	COM2 uses IRQ3
3F8 / IRQ4	COM3 uses IRQ4
2F8 / IRQ3	COM4 uses IRQ3

Onboard Parallel Port

Disabled/	There is a built-in parallel port on the onboard Super I/O chipset that provides standard, ECP, and EPP features. It has the following options:
(3BC/IRQ7)/	
(278 /IRQ5)/	
(378 /IRQ7)	

Disable

(3BC/IRQ7)Line Printer port 0
 (278 / IRQ5)Line Printer port 2
 (378 / IRQ7)Line Printer port 1

UR2 Mode

Select an operating mode for the second serial port:

Normal (default)	RS-232C serial port
IrDA SIR	IrDA-compliant serial infrared port
IrDA MIR	1 MB / sec infrared port
IrDA FIR	Fast Infrared standard
Sharp IR	4-Mb/s data transmission

Onboard Parallel Mode

SPP : Standard Parallel Port
 EPP : Enhanced Parallel Port
 ECP : Extended Capability Port

To operate the onboard parallel port as Standard Parallel Port only, choose "SPP." To operate the onboard parallel port in the ECP and SPP modes simultaneously, choose "ECP/SPP." By choosing "ECP" the onboard parallel port will operate in ECP mode only. Choosing "ECP/EPP" will allow the onboard parallel port to support both the ECP and EPP modes simultaneously. The ECP mode

has to use a DMA channel, so choose the onboard parallel port with the ECP feature. After selecting it the following message will appear: "ECP Mode Use DMA". At this time the user can choose between DMA channels 3 or 1. The onboard parallel port is EPP Spec. compliant so after the user chooses the onboard parallel port with the EPP function, the following message will be displayed on the screen: "Parallel port EPP Type." At this time either EPP 1.7 spec. or EPP 1.9 spec. can be chosen.

Parallel Port Mode

Select an operating mode for the onboard parallel (printer) port. Select Normal, Compatible, or SPP unless you are certain your hardware and software both support one of the other available modes.

SPP (default)

2.9 Supervisor / User Password Setting

■ Figure 9. Supervisor Password Setting

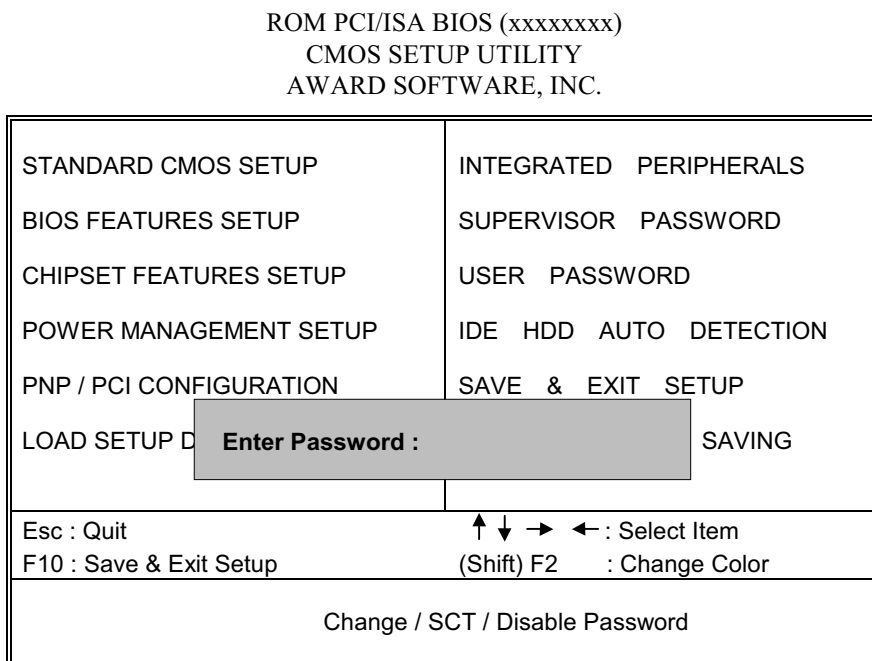

When you select this function, the following message will appear at the center of the screen to assist you in creating a password.

ENTER PASSWORD

Type the password, up to eight characters, and press <Enter>. The password you type now will clear any previously entered password

from CMOS memory. You will be asked to confirm the password. Type the password again and press <Enter>. You may also press <ESC> to abort the selection and not enter a password. To disable password, just press <Enter> when you are prompted to enter password. A message will confirm that you wish to disable the password. Once the password is disabled, the system will boot and you can enter setup freely.

PASSWORD DISABLED

If you select "System" at the Security Option of BIOS Features Setup Menu, you will be prompted for the password every time the system is rebooted or any time you try to enter Setup. If you select "Setup" at Security Option of BIOS Feature Setup Menu, you will be prompted only when you try to enter Setup.

2.10 IDE HDD Auto Detection

Automatically configure hard disk parameters. The parameters shown below are only examples.

■ **Figure 10. Auto Configuration with Optimal Settings Screen**

ROM PCI/ISA BIOS (xxxxxxx)
CMOS SETUP UTILITY
AWARD SOFTWARE, INC.

HARD DISKS	TYPE	SIZE	CYLS	HEAD	PRECOMP	LAND	SECTOR	MODE
Primary Master	:User	343	665	16	65535	664	63	NORMAL

Select Primary Slave Option (N=Skip) N							
OPTIONS	SIZE	CYLS	HEAD	PRECOMP	LANDZ	SECTOR	MODE
1(Y)	0	0	0	0	0	0	NORMAL

Note : Some Oses (like SCO-UNIX) must use "NORMAL" for installation

ESC : Skip

When you enter this utility, the screen asks you to select a specific hard disk for Primary Master. If you accept a hard disk detected by the BIOS, you can enter "Y" to confirm and then press <Enter> to check next hard disk. This function allows you to check four hard disks and you may press the <Esc> after the <Enter> to exit this function and go back to the Main Menu.

2.11 Save & Exit Setup

Save CMOS value changes to CMOS and exit setup.

■ **Figure 11. Save & Exit Setup Screen**

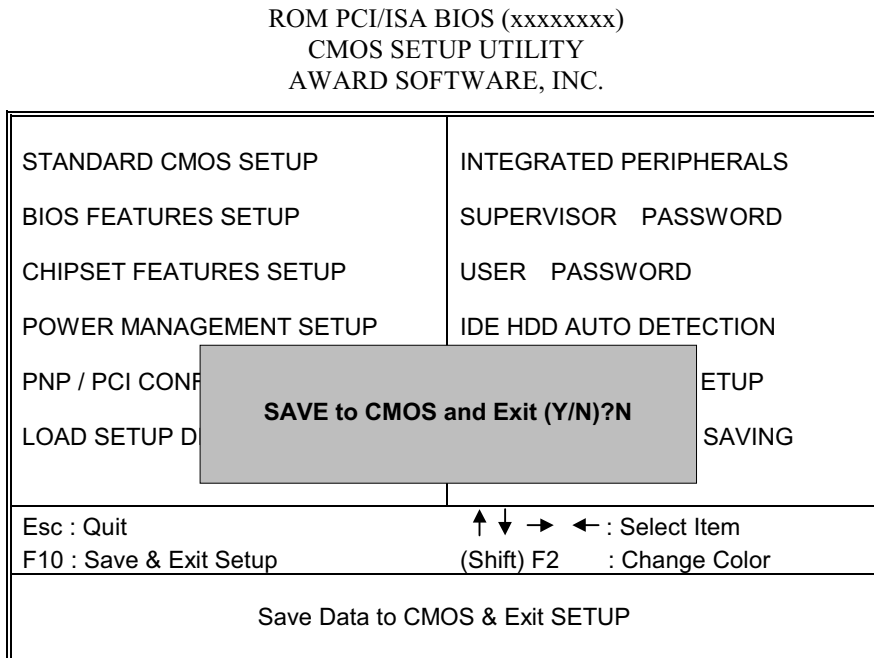

Pressing **<N>** and **<ENTER>** will return you to the Main Menu.

Pressing **<Y>** and **<ENTER>** will save the system parameters and continue with the booting process.

2.12 Exit Without Saving

Abandon all CMOS value changes and exit setup.

■ **Figure 12. The Save Settings and Exit Screen**

ROM PCI/ISA BIOS (xxxxxxxx)
CMOS SETUP UTILITY
AWARD SOFTWARE, INC.

STANDARD CMOS SETUP	INTEGRATED PERIPHERALS
BIOS FEATURES SETUP	SUPERVISOR PASSWORD
CHIPSET FEATURES SETUP	USER PASSWORD
POWER MANAGEMENT SETUP	IDE HDD AUTO DETECTION
PNP / PCI CONF	TUP
LOAD SETUP DE	AVING
Quit Without Saving (Y/N)?N	
Esc : Quit	↑ ↓ → ← : Select Item
F10 : Save & Exit Setup	(Shift) F2 : Change Color
Abandon All Data & Exit SETUP	

Pressing **<N>** and **<ENTER>** will return you to the Main Menu.

Pressing **<Y>** and **<ENTER>** will continue with booting process without saving any system parameters.

2.13 Application Software

- Please use the "BIOS Utility" diskette to setup Flash Memory.
- The diskette contains the intelligent installation utility **AWDFLASH.EXE**, displayed below.

■ **Figure 13. Flash Memory Writer**

FLASH MEMORY WRITER Vxx Copyright (C) 1992-1994 Award Software, Inc.,	
For xx-xxxxxxxxxxxxxxxxxxx Flash Type -	DATE: xx/xx/xxxx
File Name to Program:	<input type="text"/>
Error Message :	Do You Want To Save Bios (Y/N)?

2.14 IDE Driver Setup

How to install drivers:

One of the two methods listed below can be used to install the driver:

I. Use **INSTALL.BAT** under Windows 95 environment.

OR

II. Use the following sequence step by step:

.Click the start button. Choose settings, then **'Control Panel'** Double-Click **'Add New Hardware'**.

.Click **'Next'**.

.Switch to **'No'** - don't let Windows search for your new hardware, and click **'Next'**.

.Select **'Hard disk controllers'** and click **'Next'**.

.Click the button **'Have Disk'** (or press **Alt+H**).

.Make sure the disk for installation is in drive A(or drive B), and then click **'OK'**.

.A **'Select Device'** dialog box will be displayed.

.Select the device that you wish to install and click **'Next'**.

.After this installation procedure is complete, restart the computer.

How to uninstall drivers :

Use **UNINSTAL.BAT** under Windows 95 environment.

Attention :

1. When Win95 install the IDE driver software for primary and secondary channel, please **DO NOT RESTART COMPUTER after yet. Finish primary channel, then** let Win95 continue to install software for secondary channel. After secondary channel is finished, **RESTART COMPUTER** to let new installed IDE driver to take effect.
2. If you have any DOS Real-mode driver on your system, then will be conflict with the ALi Bus Master IDE Driver and Real-mode ATAPI CD-ROM or IDE device driver. ALL REFERENCES TO REAL-MODE DRIVERS (IDE or ATAPI) IN THE AUTOEXEC.BAT AND CONFIG.SYS SHOULD BE REMOVED.
3. Sometimes, the ALi IDE controller has already been installed with the standard driver provided by Microsoft. In order to use ALi IDE controller with the driver we provided, it is necessary to remove the standard driver from "**Control Panel / System/ Device Manager**".
4. This version support Ultra DMA/33 feature.
5. If you found the CD-ROM cannot be recognized by Windows 95 after you installed Ali bus master driver, please run
"X:\WIN95\PATCH\W95PATCH.EXE"
(X : is the floppy drive where this disk located).

2.15 AGP Driver Setup

2.15.1 System requirements Windows 95:

1. Microsoft Windows 95 OSR2.1 or later version
2. ALi M1541 AGP Driver (AgartD.VXD)
3. AGP VGA Card with Driver
4. Direct X5

Windows 98:

1. Microsoft Windows 98
2. ALi M1541/M1621 AGP Driver (ALiPCIMP.PCI)
3. AGP VGA Card with Driver

2.15.2 Installation Instructions Windows 95:

1. Install Windows 95 OSR2 or later version.
2. Upgrade Windows 95 to version OSR2.1 by running USBSUPP.EXE. You can get this file from Microsoft (www.microsoft.com).
3. Install Microsoft DirectX 5.0 version or later You can get this driver from Microsoft.
4. Install ALi M1541 AGP Driver
 - Run this setup program named "setup.exe".
 - This program will detect the Windows version automatically and modify the registry to load the proper driver.
5. Install the VGA driver for Windows 95.

Windows 98:

1. Install Windows 98.
2. Install ALi M1541/M1621 AGP Driver
 - Run this setup program named "setup.exe".
 - This program will detect the Windows version automatically and modify the registry to load the proper driver.
3. Install the VGA driver.

2.15.3 Uninstallation Instructions Windows 95 and Windows 98:

1. Open "Control Panel" folder
2. Invoke "Add\Remove Programs" icon
3. Choose "uninstall ALi M1541/M1621 drivers" item
4. Click on "Add/Remove" button to remove drivers.

2.16 Serial and Parallel Interface Ports

This system equipped with two serial ports and one parallel port. Both types of interface ports will be explained in this chapter.

The Serial Interface Port

The serial interface port is sometimes referred to as a RS-232 port or an asynchronous communications port. Mice, printers, modems and other peripheral devices can be connected to a serial port. The serial port can also be used to connect your computer with another computer system. If you wish to transfer the contents of your hard disk to another system it can be accomplished by using each machine's serial port.

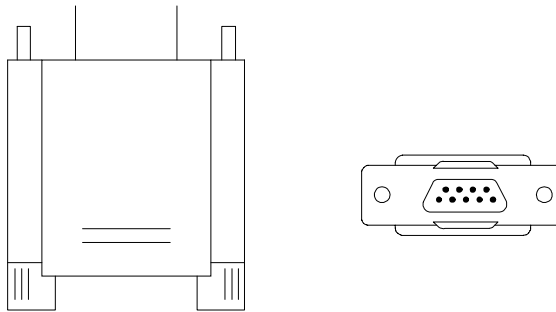

The serial ports on this system have two types of connectors, one 9-pin and one 25-pin. Some older computer systems and peripherals may only have a 25-pin connector. Should you need to connect your 9-pin serial port to a 25-pin serial port, you can purchase a 9-to-25 pin adapter.

Connectivity

The many ways that a serial port can be used make it necessary to be familiarized with the pinout diagram. The following chart gives you the function of each pin on the 9-pin connector. This information can be used when configuring certain software programs to work with the serial port.

Signal	Name	DB9 PIN	DB25 PIN
DCD	Data Carrier Detect	1	8
RX	Receive Data	2	3
TX	Transmit Data	3	2
DTR	Data Terminal Ready	4	20
GND	Signal Ground	5	7
DSR	Data Set Ready	6	6
RTS	Request to Send	7	4
CTS	Clear to Send	8	5
RI	Ring Indicator	9	22

Special Applications

There are two types of serial devices that can be connected to a serial port. One of the devices is called the “DTE” (Data Terminal Equipment) and the other device is called the “DCE” (Data Communications Equipment). If a modem is connected to a computer, for example, the modem is called the DCE and the computer is called the DTE. In situations such as this, the pins on the serial ports can be connected straight through.

In instances when there are two DTE devices connected together, such as a computer and a printer, a special adapter called a “Null Modem” is needed to make communication between the two devices possible.

When using the serial port to communicate between devices, one problem in particular may arise. Some manufacturers use one set of signals to begin communication with another device and other manufacturers do not use these signals to begin communication. If you encounter a communication problem that cannot be resolved using a null modem, it can generally be assumed that one device is using the initialization signals and the other device is not. This can usually be resolved by wiring the RTS, CTS, and DCD pins together.

Serial Ports/COM Ports

The two serial ports on the computer are called COM1 and COM2, respectively. If you wish, two more serial ports can be added onto the computer using optional hardware. Should you choose to add the extra Serial ports (COM ports), they would be called COM3 and COM4.

When using serial ports to communicate with a peripheral devices, be sure to assign only one COM port number to each device. For example, if a printer and a scanner are both connected to your computer through serial ports the printer must be assigned one COM port (i.e. COM1) and the scanner must be assigned the other COM port (i.e. COM2). No two devices can be assigned to one COM port. Each peripheral must have its own COM port.

NOTE: Four serial ports may be installed on the computer. However, no more than two ports can be used simultaneously.

*If you have installed an internal modem, be careful not to assign a COM port number that has already been assigned to another device. This error is common.

When installing a device that is going to require the use of a serial port, use a diagnostic program to find out which ports are available. It may be necessary to remove expansion cards that have serial ports in order to check their jumper settings. The jumper settings will indicate which COM port the card has been assigned. Checking the expansion card will eliminate mistakes in overlapping COM ports. Once you have completed the installation of peripheral devices using the serial ports, be sure that the communication parameters such as baud rate, parity bit, etc. are matching. If your computer is set for a baud rate of 9600 and your modem is set for a baud rate of 2400, you will not be able to send messages. The manuals that accompany the peripheral devices will inform you on the procedure for setting their parameters. Software manuals will also have instructions on setting parameters.

Parallel Interface Ports

Unlike the serial port, parallel interface ports have been standardized and should not present any difficulty interfacing peripherals to your system. Sometimes called a Centronics port, the parallel port is almost exclusively used with printers. The parallel port on your system has a 25-pin, DB5 connector (see picture below). The pinouts for the parallel port are shown in the table below.

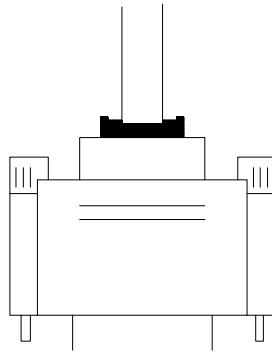
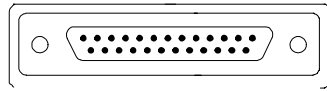

Signal	Pin
-Strobe	1
Data 0	2
Data 1	3
Data 2	4
Data 3	5
Data 4	6
Data 5	7
Data 6	8
Data 7	9
-Ack	10
Busy	11
Paper Empty	12
+Select	13
-Auto FDXT	14
-Error	15
-Init	16
-SLCTN	17
Ground	18
Ground	19
Ground	20
Ground	21
Ground	22
Ground	23
Ground	24
Ground	25
Ground	26

3. Trouble Shooting

PROBLEM

No power to the system at all. Power light does not illuminate, fan inside power supply does not turn on. Indicator light on keyboard does not turn on.

PROBABLE CAUSE	DIAGNOSIS	SOLUTION
Power cable is unplugged.	Visually inspect power cable	Make sure power cable is securely plugged in
Defective power cable.	Visual inspection, try another cable.	Replace cable.
Power supply failure.	Power cable and wall socket are OK, but system is still dead.	Contact technical support.
Faulty wall outlet; circuit breaker or fuse blown.	Plug in device known to work in socket and test	Use different socket, repair outlet, reset circuit breaker or replace fuse.

PROBLEM

System inoperative. Keyboard lights are on, power indicator lights are lit, hard drive is spinning.

PROBABLE CAUSE	DIAGNOSIS	SOLUTION
Expansion card is partially dislodged from expansion slot on the motherboard.	Turn off computer. Take cover off system unit. Check all expansion cards to ensure they are securely seated in slots.	Using even pressure on both ends of the expansion card, press down firmly on expansion card.
Defective floppy disk drive or tape drive.	Turn system off. Disconnect the cables from one of the floppy drives. Turn on the floppy drives. Turn on the system, check to see if the keyboard operates normally. Repeat until you have located defective unit.	Contact Technical Support.
Defective expansion card.	Turn computer off. Remove an expansion card	Make sure expansion card is secure in expansion socket.

PROBLEM

System does not boot from hard disk drive, can be booted from floppy disk drive.

PROBABLE CAUSE	DIAGNOSIS	SOLUTION
Connector between hard drive and system board unplugged.	When attempting to run the FDISK utility described in the HARD DISK section of this manual you get a message, INVALID DRIVE SPECIFICATION.	Check cable running from disk to disk controller board. Make sure both ends are securely plugged in; check the drive type in the Standard CMOS Setup (see HARD DISK section of this manual).
Damaged Hard Disk or Disk Controller.	Format hard disk; if unable to do so the hard disk may be defective.	Contact Technical Support.
Hard Disk directory or FAT is scrambled.	Run the FDISK program, format the hard drive (see HARD DRIVE section of manual). Copy data that was backed up onto Hard Drive.	Backing up the hard drive is extremely important. All Hard Disk are capable of breaking down at any time.

PROBLEM

System only boots from floppy Disk. Hard disk can be read and applications can be used but booting from Hard Disk is impossible.

PROBABLE CAUSE	DIAGNOSIS	SOLUTION
Hard Disk boot program has been destroyed.	A number of causes could be behind this.	Back up data and applications files. Reformat the Hard Drive as described in the Hard Drive section of this manual. Re-install applications and data using backup disks.

PROBLEM

Error message reading "SECTOR NOT FOUND" or other error messages not allowing certain data to be retrieved.

PROBABLE CAUSE	DIAGNOSIS	SOLUTION
A number of causes could be behind this.	Use a file by file backup instead of an image backup in order to backup the Hard Disk.	Back up any salvageable data. Then low level format, partition, and high level format the hard drive (see Hard Disk section of this manual for instructions). Re-install all saved data when completed.

PROBLEM

Disk formatted on IBM PS/2 will not operate with this system.

PROBABLE CAUSE	DIAGNOSIS	SOLUTION
The IBM PS/2 uses a different format than other computers.	IBM PS/2 disk format will not work in an AT type computer.	Format disk in the AT type computer insert disk into the IBM PS/2 and copy the files you wish.

PROBLEM

After installing an expansion card (network card, tape drive card, etc.) the system no longer works properly.

PROBABLE CAUSE	DIAGNOSIS	SOLUTION
No power to monitor.	All or part of the system may be inoperable. The new card may work but a mouse or COM port may not work	Change the interrupt or RAM address on the new expansion card. See the documentation that came with the new card in order to change pin settings. Many expansion devices come with proprietary software that will assist you in doing this.

PROBLEM

Screen message says "Invalid Configuration" or "CMOS Failure."

PROBABLE CAUSE	DIAGNOSIS	SOLUTION
Incorrect information entered into the configuration (setup) program.	Check the configuration program. Replace any incorrect information.	Review system's equipment . Make sure correct information is in setup.

PROBLEM

Screen is blank.

PROBABLE CAUSE	DIAGNOSIS	SOLUTION
No power to monitor.		Check the power connectors to monitor and to system. Make sure monitor is connected to display card, change I/O address on network card if applicable
Monitor not connected to computer.		See instructions above.
Network card I/O address conflict.		See instructions above.

PROBLEM

PROBABLE CAUSE	DIAGNOSIS	SOLUTION
Memory problem, display card jumpers not set correctly.		Reboot computer. Reinstall memory, make sure that all memory modules are installed in correct sockets. Check jumper and switch settings on display card. See display card section for information on settings.
Computer virus.		Use anti-virus programs (McAfee, E-Prot, etc) to detect and clean viruses.

PROBLEM

Screen goes blank periodically.

PROBABLE CAUSE	DIAGNOSIS	SOLUTION
Screen saver is enabled.		Disable screen saver.

PROBLEM

Keyboard failure.

PROBABLE CAUSE	DIAGNOSIS	SOLUTION
Keyboard is disconnected.		Reconnect keyboard. Check keys again, if no improvement replace keyboard.

PROBLEM

No color on screen.

PROBABLE CAUSE	DIAGNOSIS	SOLUTION
Faulty Monitor.		If possible, connect monitor to another system. If no color replace monitor.
CMOS incorrectly set up.		Call technical support.

PROBLEM

Floppy drive light stays on.

PROBABLE CAUSE	DIAGNOSIS	SOLUTION
Floppy Drive cable not connected correctly.		Reconnect floppy cable making sure PIN1 on the Floppy Drive corresponds with PIN1 on Floppy cable connector.

PROBLEM

Error reading drive A:

PROBABLE CAUSE	DIAGNOSIS	SOLUTION
Bad floppy disk.		Try new floppy disk
Floppy disk not formatted		Format floppy disk (type FORMAT A:type ENTER)>

PROBLEM

C: drive failure.

PROBABLE CAUSE	DIAGNOSIS	SOLUTION
SETUP program does not have correct information.		Boot from drive A: using DOS system disk. Input correct information to SETUP program.
Hard Drive cable not connected properly.		Check Hard Drive cable.

PROBLEM

Cannot boot system after installing second hard drive.

PROBABLE CAUSE	DIAGNOSIS	SOLUTION
Master/Slave jumpers not set correctly.		Set Master/Slave jumpers correctly.
Hard Drives not compatible / different manufacturers.		Run SETUP program and select correct drive types. Call Drive manufacturers for compatibility with other drives.

PROBLEM

Missing operating system on hard drive.

PROBABLE CAUSE	DIAGNOSIS	SOLUTION
CMOS setup has been changed.		Run setup and select correct drive type.

PROBLEM

Certain keys do not function.

PROBABLE CAUSE	DIAGNOSIS	SOLUTION
Keys jammed or defective.		Replace keyboard.

PROBLEM

Keyboard is locked, no keys function.

PROBABLE CAUSE	DIAGNOSIS	SOLUTION
Keyboard is locked.		Unlock keyboard

10/07/1998
MADE IN TAIWAN
R.O.C