

**TS-APM3
TS-APL3
USER'S MANUAL
Intel® Socket 370 Celeron™ /
Pentium® III FC-PGA Series**

Transcend

***Your Supplier, Your Partner,
Your Friend.***

TS-APM3/TS-APL3 Motherboard

Supporting Intel® Socket 370 Celeron™/Pentium III™ FC-PGA Series Processor

66/100/133 MHz Front Side Bus Frequency

AGP 4X

VIA® P6 ProSavage 133 Chipset

Welcome!!

Congratulations on your purchase of this great value motherboard, with its range of special features and innovative onboard functions, built around the advanced architecture of the new VIA® P6 ProSavage 133 Chipset. More details to follow later in this manual.

Our Website

Please come and visit us at our website on <http://www.transcendusa.com/>. You'll find plenty of interesting information about this and many other quality Transcend products.

Your User's Manual

This User's Manual is designed to help end users and system manufacturers to set up and install the motherboard. All of the information within has been carefully checked for accuracy. However, Transcend Information, Inc. (hereafter referred to as "Transcend") carries no responsibility or liability for any errors or inaccuracies which this manual may contain. This includes references to products and software. In addition, the information and specifications are subject to change without prior notice.

Disclaimer

Transcend provides this manual "as is" without any warranty of any kind, either expressed or implied, including - but not limited to - the implied warranties, conditions of merchantability or fitness for a particular purpose. Transcend, its management, employees, distributors and agents are free of liability for any indirect special, incidental or consequential damages, including loss of profits, loss of business, etc. This freedom from liability remains in effect even if Transcend has been advised of the possibility of such damages arising from any defect or error in this manual or product.

Trademarks

All brands, product names and trademarks mentioned in this document are the property of their respective owners or companies and are used solely for identification or explanation. It is Transcend policy to respect all product rights.

Copyright

This manual may not, in whole or in part, be photocopied, reproduced, transcribed, translated or transmitted, in any form or language, without the prior written consent of the manufacturer, except for copies retained by the purchaser for personal archiving purposes.

Manual Version: 1.1

Release Date: November, 2000

Copyright © November 2000 Transcend Information, Inc.

Table of Contents

| | |
|---|----------|
| CHAPTER 1 INTRODUCTION | 1 |
| 1.1 Essential Handling Precautions | 1 |
| 1.2 Checklist: Hardware Required for Setup | 2 |
| 1.3 Package Contents | 2 |
| 1.4 Specifications and Features | 3 |
| | |
| CHAPTER 2 HARDWARE INSTALLATION | 5 |
| 2.1 Transcend TS-APM3/TS-APL3 Motherboard | 5 |
| 2.2 Layout of Transcend TS-APM3/TS-APL3 Motherboard | 6 |
| 2.3 CPU Installation | 7 |
| 2.4 66/100/133MHz System Configuration | 9 |
| 2.5 CPU Internal Frequency Ratio Setting | 10 |
| 2.6 Memory Configuration | 11 |
| 2.7 Primary/Secondary IDE Connectors | 12 |
| 2.8 Floppy Disk Drive Connector | 13 |
| 2.9 Fan Power Connectors | 13 |
| 2.10 Wake-on-LAN Connector | 14 |
| 2.11 Wake-on-Modem Connector | 14 |
| 2.12 IrDA-Compliant Infrared Module Connector | 15 |
| 2.13 Panel Connectors | 15 |
| 2.14 Power Connector | 17 |
| 2.15 External Back Panel I/O Ports | 17 |
| 2.16 Clear CMOS Jumper..... | 19 |
| 2.17 Onboard Audio Setting | 19 |
| 2.18 Internal Audio Connectors | 20 |
| 2.19 Internal Serial Port Connector | 21 |

| | | |
|------|-----------------------------------|----|
| 2.20 | Internal USB Port Connector | 22 |
| 2.21 | VIO Adjust Jumper..... | 23 |

CHAPTER 3 BIOS SETUP 24

| | | |
|------|---------------------------------|----|
| 3.1 | BIOS Setup..... | 24 |
| 3.2 | The Main Menu | 24 |
| 3.3 | Standard CMOS Features..... | 26 |
| 3.4 | Advanced BIOS Features..... | 29 |
| 3.5 | Advanced Chipset Features | 33 |
| 3.6 | Integrated Peripherals | 37 |
| 3.7 | Power Management Setup..... | 41 |
| 3.8 | PnP/PCI Configurations | 46 |
| 3.9 | PC Health Status..... | 48 |
| 3.10 | Frequency/Voltage Control | 49 |
| 3.11 | Load Fail-Safe Defaults | 50 |
| 3.12 | Load Optimized Defaults..... | 50 |
| 3.13 | Supervisor Password | 51 |
| 3.14 | User Password..... | 52 |
| 3.15 | Save & Exit Setup..... | 53 |
| 3.16 | Exit Without Saving..... | 53 |

CHAPTER 4 BIOS UPGRADE 54

| | | |
|-----|---|----|
| 4.1 | How to Check Your BIOS File Name and Version | 54 |
| 4.2 | Download the Correct BIOS File from Our Web Site..... | 54 |
| 4.3 | How to Upgrade Your Motherboard BIOS | 55 |



CHAPTER 1 INTRODUCTION

1.1 Essential Handling Precautions

IMPORTANT. Read this page before unpacking your motherboard!

- **Power Supply**

Be careful! Always ensure that the computer is disconnected from the power supply when working on the motherboard and its components.

- **Static Electricity**

Static electricity may cause damage to the delicate integrated circuit chips on your motherboard. Before handling the motherboard outside of its protective packaging, ensure that there is no static electric charge in your body. A static discharge sufficiently strong enough to damage computer components is not perceptible by a human. To avoid this risk, please observe these simple precautions while handling the motherboard and other computer components:

1. If possible, wear an anti-static wrist strap. This fits around your wrist and is connected to a natural earth ground.
2. Touch a grounded or anti-static surface, or a metal fixture such as a pipe or the chassis of your system, before touching the motherboard.
3. When you have removed the motherboard from its anti-static packaging, try to hold it only by the edges, without touching any components.
4. Avoid contacting the components on add-on cards, motherboards, and modules with the gold-colored connectors which plug into the expansion slots.
5. It is safest to handle system components only by their mounting brackets.
6. Keep components which are not connected to the system in the anti-static packaging whenever possible.

These precautions help to reduce the risk of static build-up and ensure any static discharge is harmless to your equipment.

- **Battery Replacement**

The battery which holds the system settings memory (CMOS RAM) on your motherboard should not require replacement for at least five years, and probably much longer. In picture 2.2, it is located near the center of the motherboard. Incorrect computer time and/or loss of time may indicate a weak motherboard battery.

Please replace your battery only with the same type, or a similar type recommended by the battery manufacturer. If the battery is replaced incorrectly, there is a risk of a short circuit or explosion. Used batteries should be disposed of in accordance with the manufacturer's instructions and local environmental regulations.

• Electric Screwdrivers

To reduce the risk of damage to the motherboard due to excessive torque, avoid setting electric screwdrivers above 7.5 kg/cm.

1.2 Checklist: Hardware Required for Setup

It is advisable to have all of these items of hardware available before you unpack your motherboard from its anti-static packaging and start building your system.

- Computer case and chassis with appropriate power supply.
- Monitor.
- Socket 370 Central Processing Unit (CPU).
- DIMM memory module.
- PS/2 or USB Keyboard.
- PS/2 or USB Mouse.
- Hard Disk Drive.
- Floppy Disk Drive.
- CD-ROM Drive.
- (Optional) External Peripherals: printer, speakers, plotter, modem.
- (Optional) Internal Peripherals: modem, LAN cards.

1.3 Package Contents

This motherboard package should contain the following items. Please check them as soon as you unpack. If you find any damaged or missing items, please contact your retailer.

- TS-APM3/TS-APL3 motherboard
 - 1 x CD-ROM
 - 1 x FDD cable
 - 1 x Ultra DMA/66 cable
 - User 's Manual
 - 1 x External USB connector (Optional)
 - 1 x External COM2 connector (Optional)
-

1.4 Specifications and Features

• CPU

- Supports Intel® Socket 370 Celeron™ Series
- Supports Intel® Pentium III FC-PGA Series

• Chipset

- TS-APM3 : VIA VT8605+686A AGPset
- TS-APM3/B : VIA VT8605+686B AGPset
- TS-APL3 : VIA VT8604+686A AGPset
- TS-APL3/B : VIA VT8604+686B AGPset

• DRAM Memory

- Supports Synchronous DRAM
- Supports Virtual Channel Memory
- 3 x 168-pin DIMM module slots on board
- 8MB~1.5GB memory size
- 8/16/32/64/128/256/512MB SDRAM DIMM
- 64 data bits structure only
- PC100/PC133 SDRAM compliant

• I/O BUS Slot

- 1 x AGP Pro slot (TS-APM3 only)
- 5 x Master/Slave PCI slots (PCI 2.2 compliant)
- 1 x ISA slot (Shared with PCI)
- 1 x AMR slot

• I/O Functions

- Supports PIO Mode 3,4 ATAPI devices and Ultra DMA 33/66/(100,For 686B Only)
 - Supports 2 high speed UART 16550 COM ports
 - Supports SPP/EPP/ECP LPT port
 - Supports 1.44/2.88 MB floppy drive
 - Supports PS/2 Mouse and PS/2 Keyboard
 - Supports IrDA port
 - Supports 4 Universal Serial Bus (USB) ports
 - Supports VGA port
-

- Supports Line-out, Line-in and MIC-in jack.

- Supports Game/MIDI port

- **Build-in AC97 CODEC**

- AC97 2.1 Compliant

- **Award BIOS**

- Support Plug-and-Play, PC98

- Support ACPI, APM, DMI and Green Feature

- **Wake Up Features**

- Supports Wake-on-LAN function

- Remote Ring Wake Up

- Time Wake Up

- **Switching Voltage Regulator**

- Intel® VRM 8.4 compliant

- **Other Features**

- Year 2000 compliant

- Anti-Virus Boot up

- System voltage monitors for CPU Vcore, +2.5V, +3.3V, +5V and +12V

- CPU temperature monitor

- System temperature monitor

- FAN speed monitor

- **PCB Dimensions**

- ATX form factor, 4-layer PCB, 19 cm x 30.5 cm (7.5 inch x 12 inch)

CHAPTER 2 HARDWARE INSTALLATION

2.1 Transcend TS-APM3/TS-APL3 Motherboard

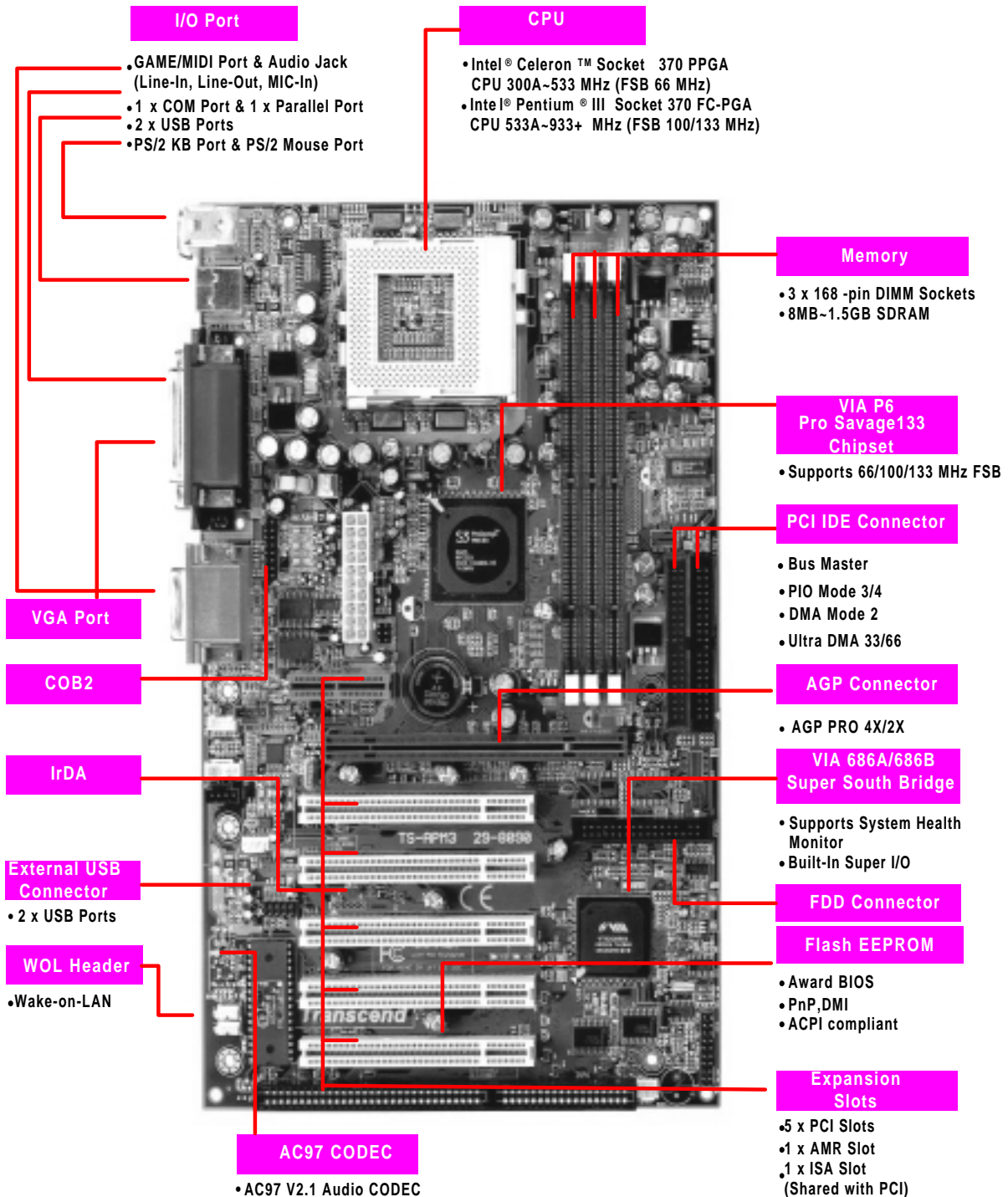

2.2 Layout of Transcend TS-APM3/TS-APL3 Motherboard

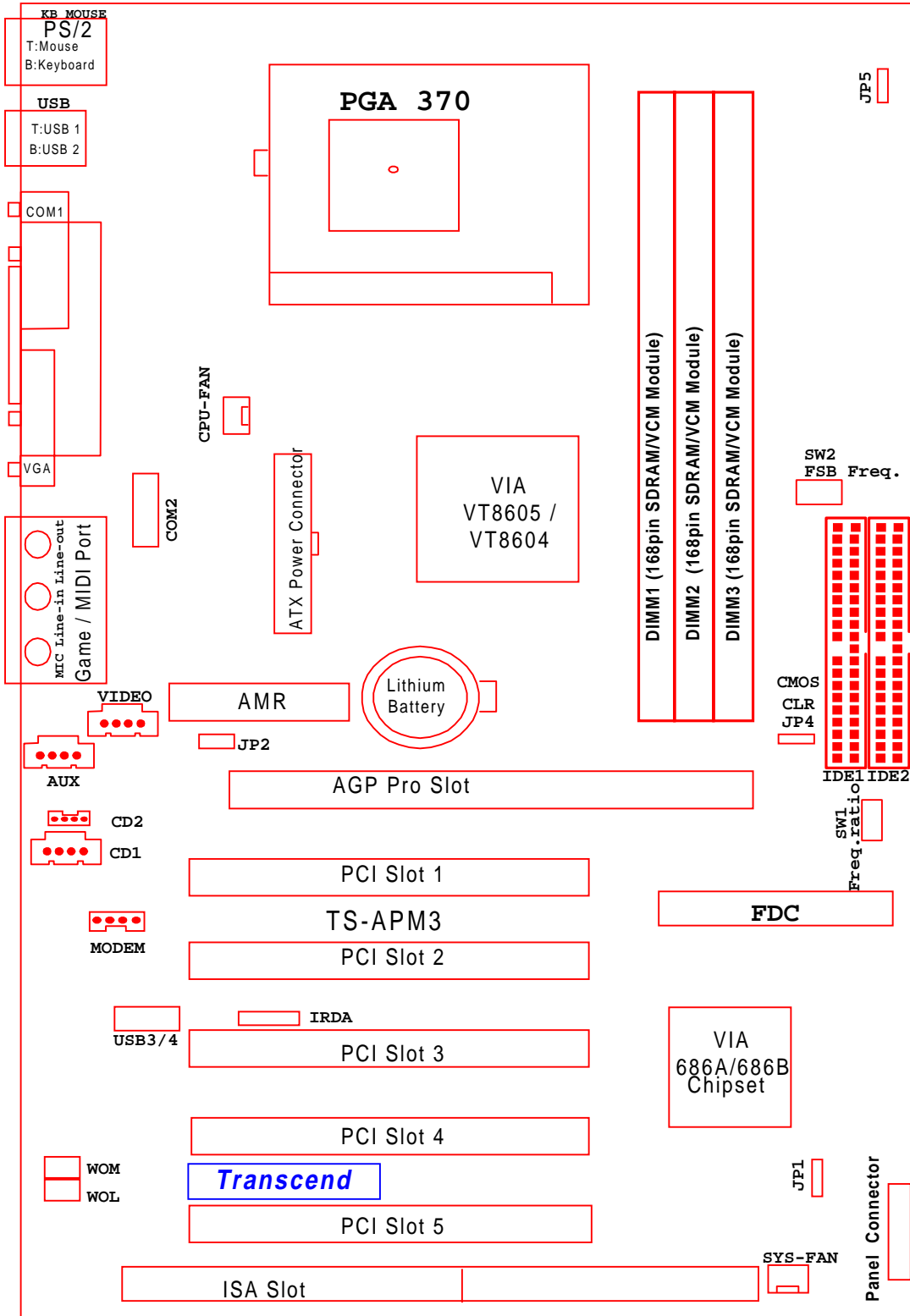

2.3 CPU (Central Processing Unit) Installation

All this point you should be familiar with the handling precautions; checked that you have all of the necessary hardware for building your system; inspected the motherboard package contents; and, looked at the layout of the motherboard. This chapter will take you step-by-step through the process of installing the different hardware devices onto your new Transcend motherboard.

Caution!

- 1. Remember to always make sure the system power is off before installing or removing any devices.**
- 2. Don't forget the static electricity precautions.**
- 3. Be careful! Inserting hardware onto your motherboard incorrectly can damage it.**

The motherboard has a ZIF Socket 370 which houses the CPU. A fan is necessary for the CPU to prevent overheating. If no fan has been supplied with the CPU, purchase and install one before you turn on your system.

WARNING! Be sure that sufficient air circulation is available across the processor's passive heatsink. Without sufficient circulation, the processor could overheat and damage both the processor and the motherboard. You may install an auxiliary fan, if necessary.

Please follow the steps below to install the CPU:

Step 1:

To install the CPU, first turn off your system and remove its cover. Locate the ZIF socket and open it by first pulling the lever sideways away from the socket then upwards at a 90-degree right angle. Insert the CPU in the correct direction, you should have a CPU fan to cover the face of the CPU. With the added weight of the CPU fan, no force is required to insert the CPU. Once completely inserted, close the socket's lever while holding down the CPU.

Step 2:

Next, Connect the CPU's fan cable to the CPU-FAN connector indicated on the diagram below. Ensure that the cable is connected correctly! It will be obvious which way it fits.

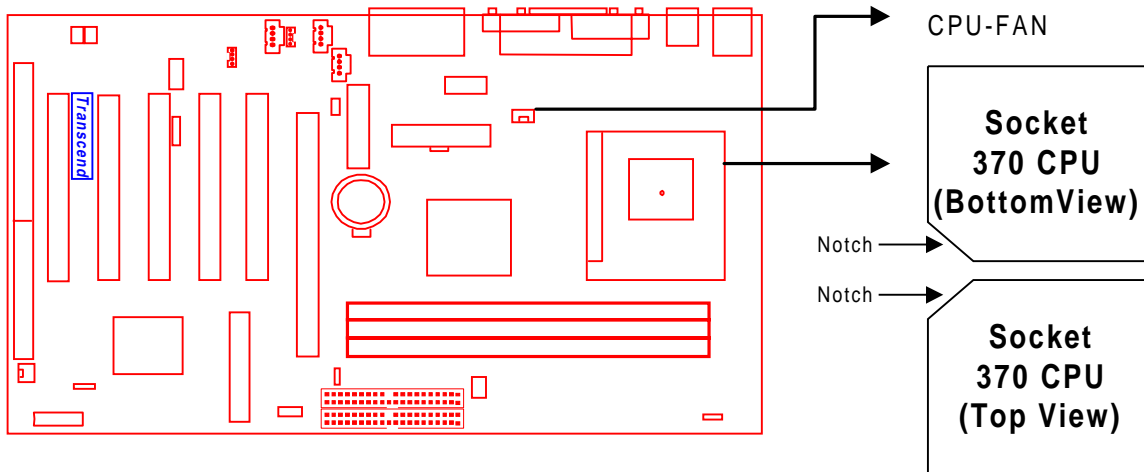

Socket 370 CPU Installation

2.4 66/100/133 MHz System Configuration

The SW2 allows you to set the FSB (Front Side Bus) for 66, 100, or 133 MHz Configuration.

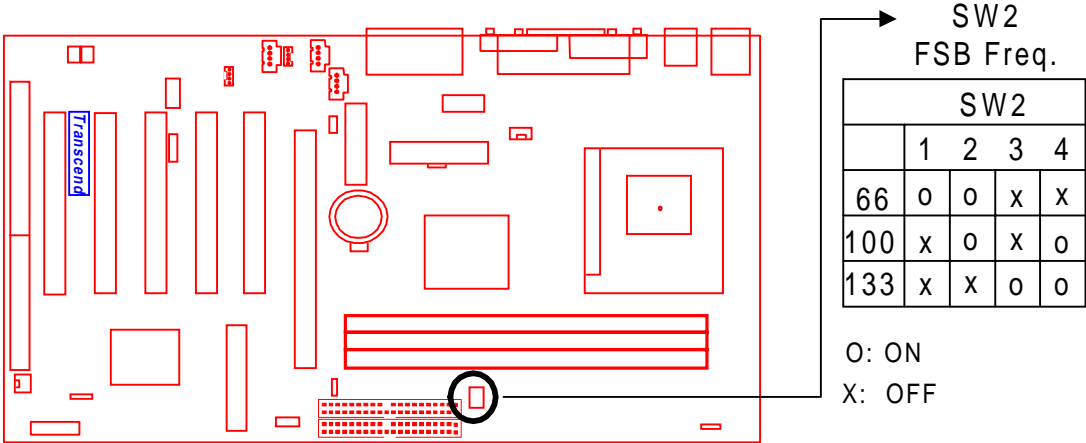

66/100/133 MHz FSB Configuration Jumper

2.5 CPU Internal Frequency Ratio Setting

The switch 1 (SW1) is designated for adjusting the CPU internal frequency ratio. The frequency ratio is defined in the table below. The internal frequency can be calculated by the following formula:

$$\text{CPU internal frequency} = \text{frequency ratio} \times \text{FSB frequency} *$$

* System bus frequency is set in “CPU Host/PCI Clock” of “Frequency / Voltage Control ” in BIOS SETUP MENU (Please refer to page 49).

NOTE: Because Intel® has locked the frequency ratio for new CPUs, setting SW1 to adjust the frequency ratio is useless. However, it is effective for older version CPUs.

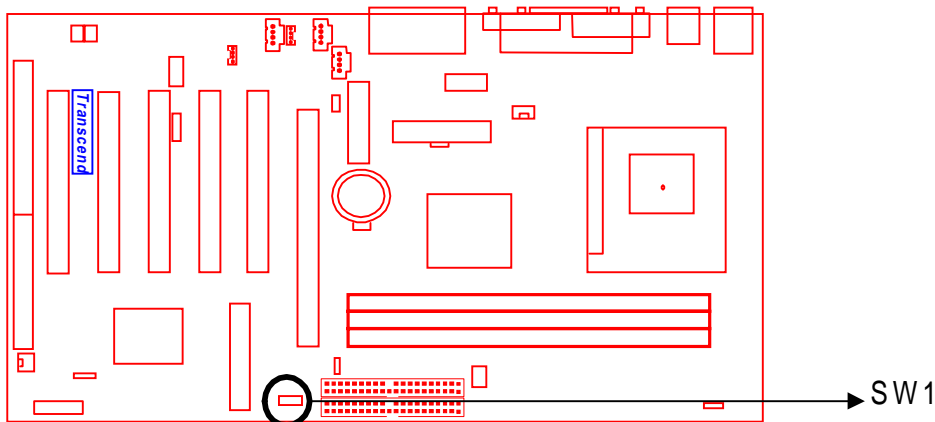

| Freq.-Ratio | SW1 | | | |
|-------------|-----|---|---|---|
| | 1 | 2 | 3 | 4 |
| 3.0 | O | O | X | O |
| 3.5 | O | X | X | O |
| 4.0 | O | O | O | X |
| 4.5 | O | X | O | X |
| 5.0 | O | O | X | X |
| 5.5 | O | X | X | X |
| 6.0 | X | O | O | O |
| 6.5 | X | X | O | O |
| 7.0 | X | O | X | O |
| 7.5 | X | X | X | O |

O: ON
X: OFF

CPU Internal Frequency Ratio Setting

2.6 Memory Configuration

This motherboard must be installed with DIMMs (Dual Inline Memory Modules). The DIMMs must be 3.3 volt synchronous DRAM modules. The VIA P6 ProSavage 133 chipset supports PC100, PC133 and Virtual Channel Memory (VCM). You can install memory in any combination as follows:

| DIMM Location | 168-pin DIMM |
|---------------|---|
| DIMM1 | SDRAM 8,16, 32, 64,128, 256, 512 MBytes |
| DIMM2 | SDRAM 8,16, 32, 64,128, 256, 512 MBytes |
| DIMM3 | SDRAM 8,16, 32, 64,128, 256, 512 MBytes |
| Total Memory | 1.5 GBytes (max.) |

NOTE: Different types of DRAM modules should not be installed on one motherboard at the same time.

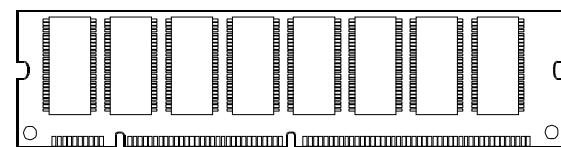
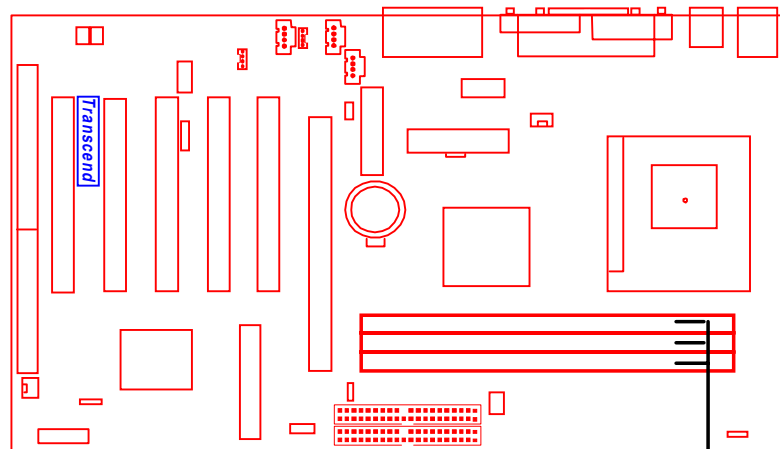

- 168Pin SDRAM / VCM Module (DIMM1)
- 168Pin SDRAM / VCM Module (DIMM2)
- 168Pin SDRAM / VCM Module (DIMM3)

168Pin DIMM Sockets

2.7 Primary/Secondary IDE Connectors (Two 40-pin IDE)

This mainboard supports two 40-pin IDE connectors marked as IDE1 (primary IDE channel) and IDE2 (secondary IDE channel). Each channel supports two IDE devices, for a total of four devices. Connect your Hard Disk (the main one if you are using more than one) to the “Master” connector (at the end of the cable) and connect it to IDE1 (see important note below). If your HDD supports UltraDMA/66, you must use an 80-wire cable, otherwise the HDD won't be able to reach this speed.

If you intend to operate two IDE devices from the same channel, one device must be set to “Master” mode, the other to “Slave” mode. Hard disk drives, CD ROM drives and other IDE devices can be set as either “master” or “slave”, depending on the device's jumper settings. Please refer to the device's user manual for more information.

NOTE: The connectors must be attached properly to the IDE channels. Ensure that the red stripe on one edge of the ribbon cable (this may be faint and could also be a dotted line) is the closest to PIN1 (on the left with the motherboard as oriented in the picture below).

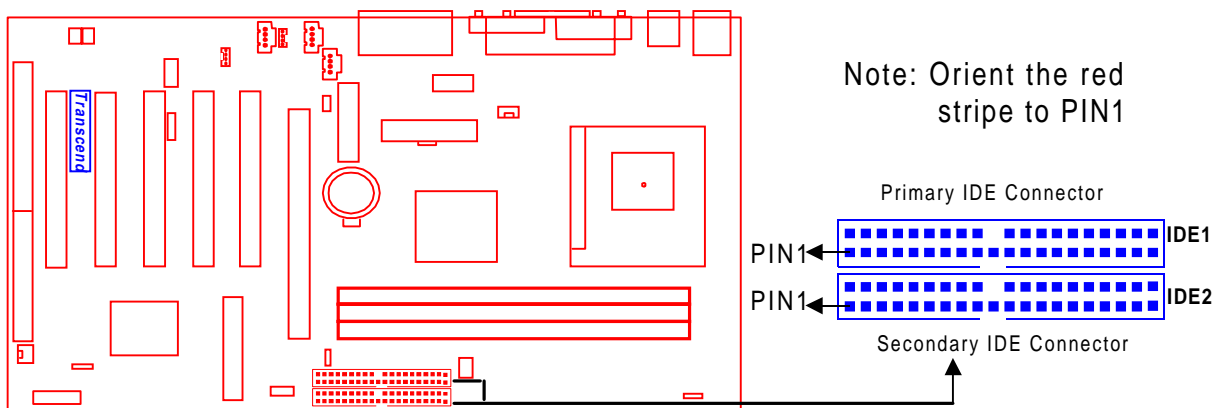

IDE Connectors

2.8 Floppy Disk Drive Connector (34-pin FDC)

This connector supports the provided floppy disk drive ribbon cable. After connecting the single plug end of this cable to the motherboard, connect the two plugs on the other end to the floppy drive.

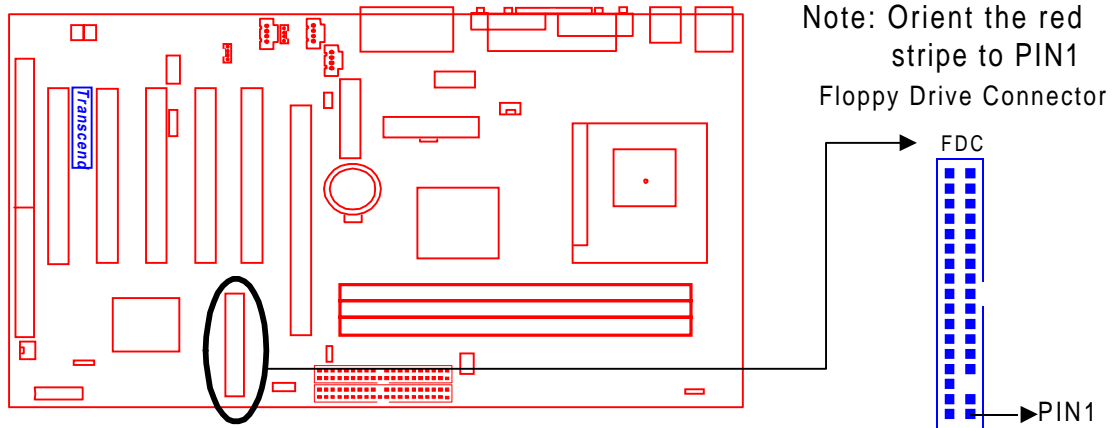

Floppy Disk Drive Connector

2.9 Fan Power Connectors

There are two fan power connectors on the motherboard: the CPU-FAN and the SYS-FAN. Each connector provides +12V power. Make sure the power cables are connected in the right direction damage may occur. These connectors support cooling fans of 500 mA (6W) or less.

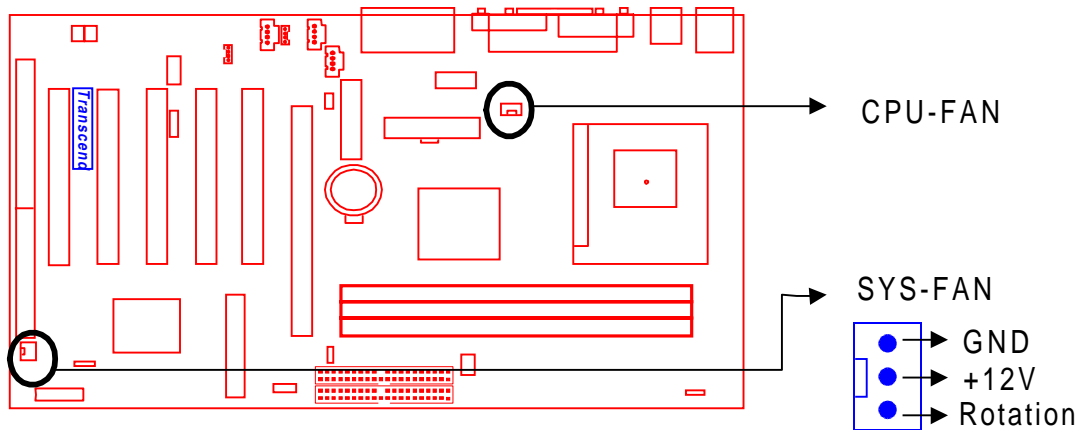

Fan Power Connectors

2.10 Wake-on-LAN Connector (3-pin WOL)

This connector connects to LAN cards with a Wake-on-LAN output. The system can be powered up when a wakeup packet or signal is received from the LAN card.

NOTE: This function requires that the “LAN Wake Up” function in the **POWER MANAGEMENT SETUP** is set to “Enabled” and that your system has an ATX power supply with at least 720mA +5V standby power.

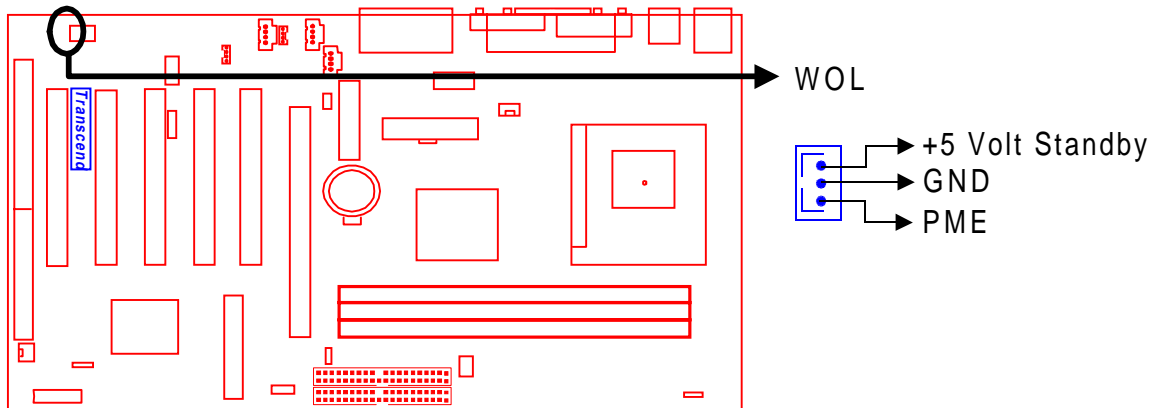

Wake-On-LAN Connector

2.11 Wake-on-Modem Connector (3-pin WOM)

This connector allows the system to be powered up upon receipt of a call via the modem.

NOTE: This function requires a modem which supports the Ring Wake-Up function (see page 44) and that your system has an ATX power supply with at least 720MA+5V standly power.

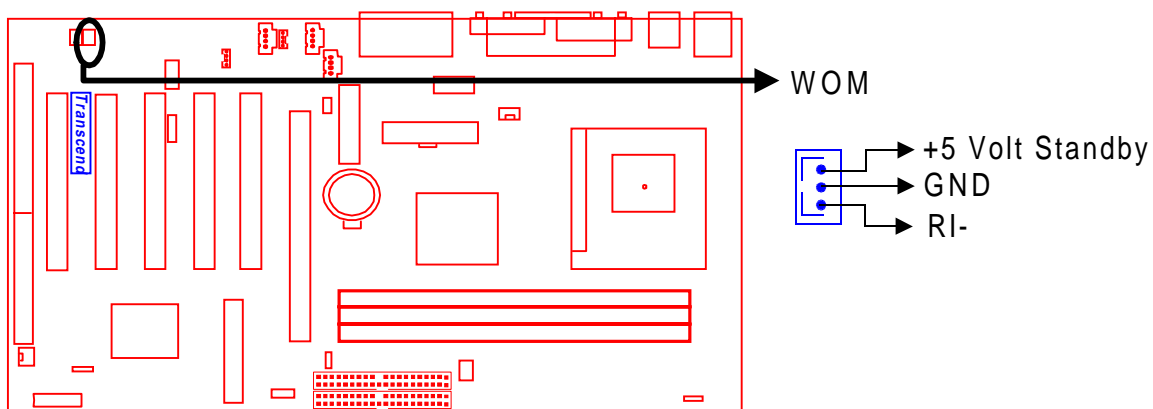

Wake-On-Modem Connector

2.12 IrDA-Compliant Infrared Module Connector (5-pin IrDA)

The IrDA connector can be configured to support a wireless infrared module. With this module and application software such as Laplink or Win95 Direct Cable Connection, the user can transfer files to or from laptops (notebooks), PDAs and printers.

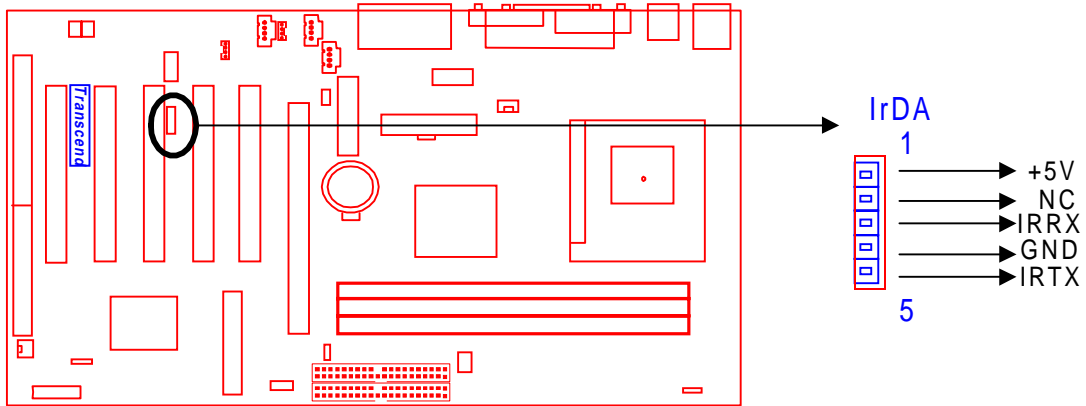

IrDA Connector

2.13 Panel Connectors

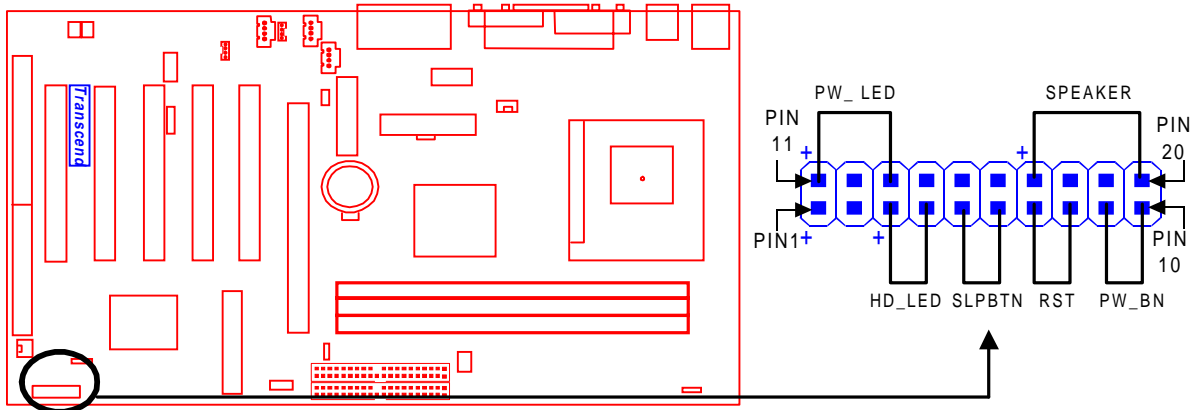

Panel Connectors

HD_LED (2-pin HD_LED)

This 2-pin connector connects to the LED of the hard disk. The LED lights up when the HDD is active.

PIN3 : +5V

PIN4 : GND

Sleep Button Lead (2-pin SLPBTN)

PIN5 : SLPBTN

PIN6 : GND

Reset Switch Lead (2-pin RST)

This 2-pin connector connects to the case-mounted reset switch for rebooting your computer without turning off your power switch.

PIN7 : RST

PIN8 : GND

Software Power-Off Lead (2-pin PW_BN)

Attach the PW_BN Switch of the panel to this connector.

PIN9 : PW_BN

PIN10 : GND

Power LED Lead (3-pin PW_LED)

This 3-pin connector attaches to the power LED.

PIN11 : +5V

PIN12 : NC

PIN13 : GND

Speaker (4-pin SPEAKER)

This 4-pin connector connects to the case-mounted speaker.

PIN17 : +5V

PIN18 : GND

PIN19 : NC

PIN20 : SPK

2.14 Power Connector (20-pin PWR-CONN)

Make sure to plug the ATX power supply connector in the right direction. The pin definition is shown below. Make sure that your ATX power supply can support at least 720mA on the standby lead.

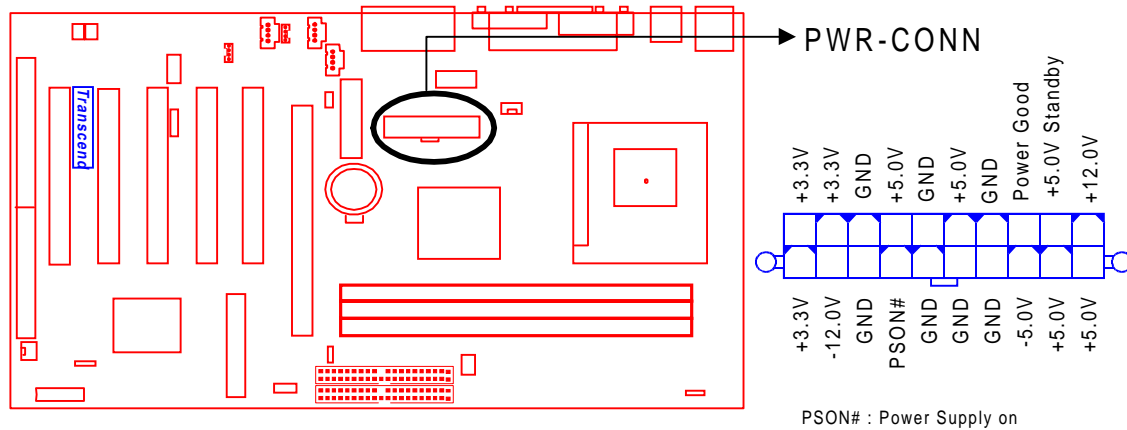

Power Connector

2.15 External Back Panel I/O Ports

There are 10 kinds of external connectors on the motherboard. **The view angle of the drawing shown on next page is from the back panel of the housing.**

1. PS/2 Mouse Port (Green, 6-pin MOUSE)

The onboard PS/2 Mouse port is a 6-pin Mini-Din connector marked "MOUSE"

2. PS/2 Keyboard Port (Purple, 6-pin KB)

The onboard PS/2 Keyboard port is a 6-pin Mini-Din connector marked "KB".

3. Universal Serial Bus (USB) Ports 1 & 2 (Black, two 4-pin USBs)

You can attach USB devices to the USB port. The motherboard contains two USB ports, which are marked as "USB". (USB Ports 3 & 4 are on-board connectors with 2x5 Header.

4. Parallel Port (Burgundy, 25-pin PRN)

The onboard printer port is a 25-pin D-type connector marked "PRN".

5. Serial Port (Turquoise, one 9-pin COM1)

The external back panel serial port is a 9-pin D-type connector marked as “COM1”. (The second onboard serial port “COM2” is an internal 10-pin header connector. See page 21 for the location and details.)

6. Display VGA Port (Blue 15-pin VGA)

The onboard VGA port is a 15-pin D-type connector marked “VGA”.

7. Game Port / MIDI Port (Gold 15-pin GAME)

The onboard Game port / MIDI Port is a 15-pin D-type connector marked “GAME”.

8. Line_out (Lime Green 1/8” LINE_OUT)

The onboard Line_out connector is a 1/8” stereo audio jack marked “LINE_OUT”.

9. Line_in (Light blue 1/8” LINE_IN)

The onboard Line_in connector is a 1/8” stereo audio jack marked “LINE_IN”.

10. MIC_IN (Pink 1/8” MIC_IN)

The onboard MIC_in connector is a 1/8” stereo audio jack connector marked “MIC”.

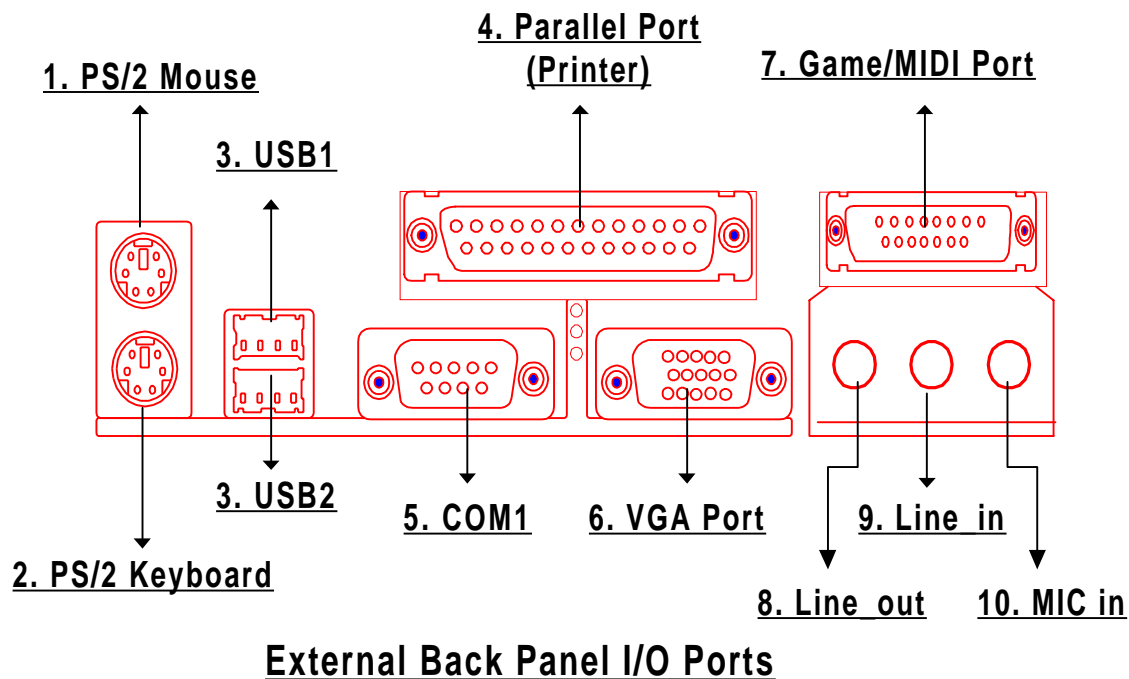

2.16 Clear CMOS Jumper (3-pin JP4)

To clear the CMOS data, you should turn off your computers power and short pin2 and pin3 of JP4.

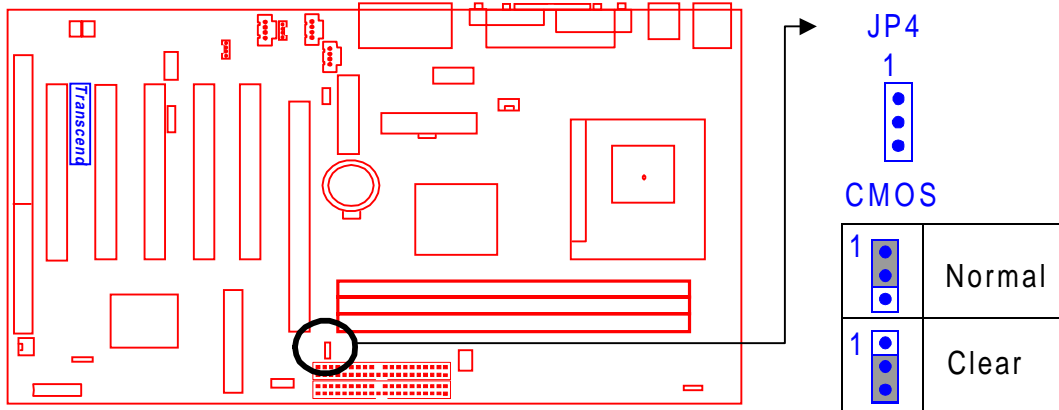

Clear CMOS Jumper

2.17 Onboard Audio Setting (3-Pin JP2)

For an external AMR card, the onboard audio CODEC can be enabled or disabled via this jumper. Please disable the onboard audio CODEC, if you want to use an AMR Sound Card.

Note : If you want to use a PCI Sound Card with audio controller on it, please disable the “OnChip Sound” function in “Advanced Chipset Features” (See Page 35).

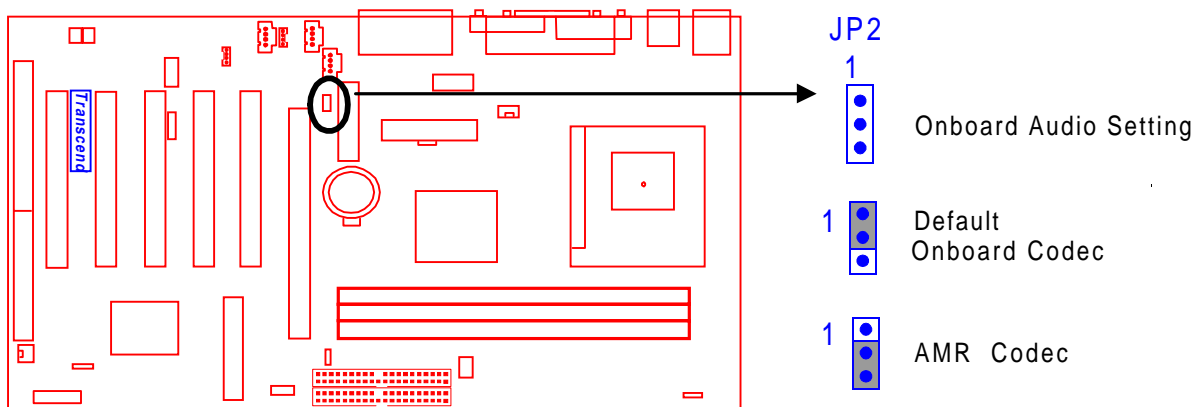

Audio Selection Jumper

2.18 Internal Audio Connectors

These connectors allow you to receive stereo audio input from sound sources such as a CD-ROM, TV tuner, or MPEG card. The MODEM connector allows the onboard audio to interface a voice modem card with a matched connector. It also allows the sharing of mono_in (such as a phone) and mono_out (such as a speaker) between the onboard audio and the voice modem card.

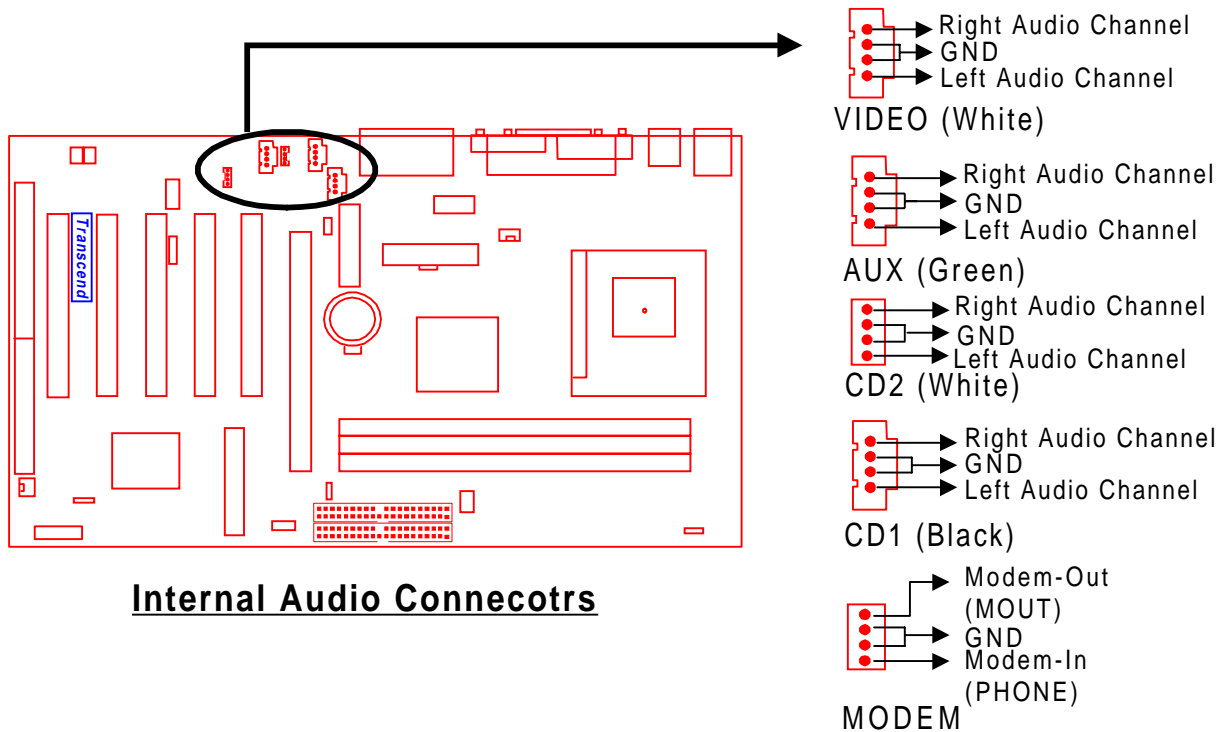

2.19 Internal Serial Port Connector (10-pin COM2)

You can use the provided serial port bracket to add a serial port for additional serial devices. Regarding the onboard COM1, please refer to Section 2.15 “External Back Panel I/O Ports” (page 18).

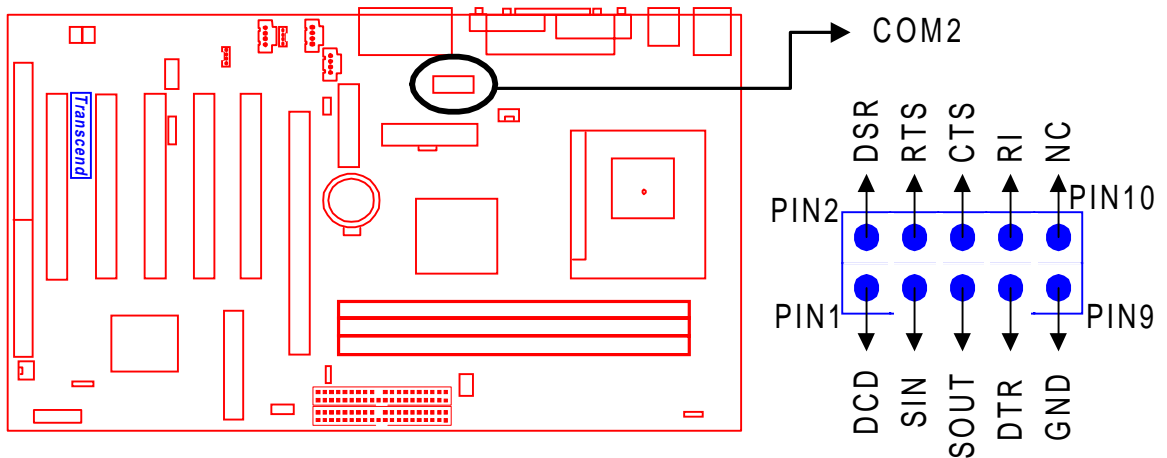

Internal Serial Port Connector COM2

2.20 Internal USB Port Connector (10-Pin USB3/4)

You can use the provided serial port bracket to add a serial port for additional serial devices. Regarding the onboard USB, please refer to Section 2.15 “External Back Panel I/O Ports” (page 17).

NOTE: Please make sure that the two red stripes on the cable are seated on **PIN1** and **PIN2**.

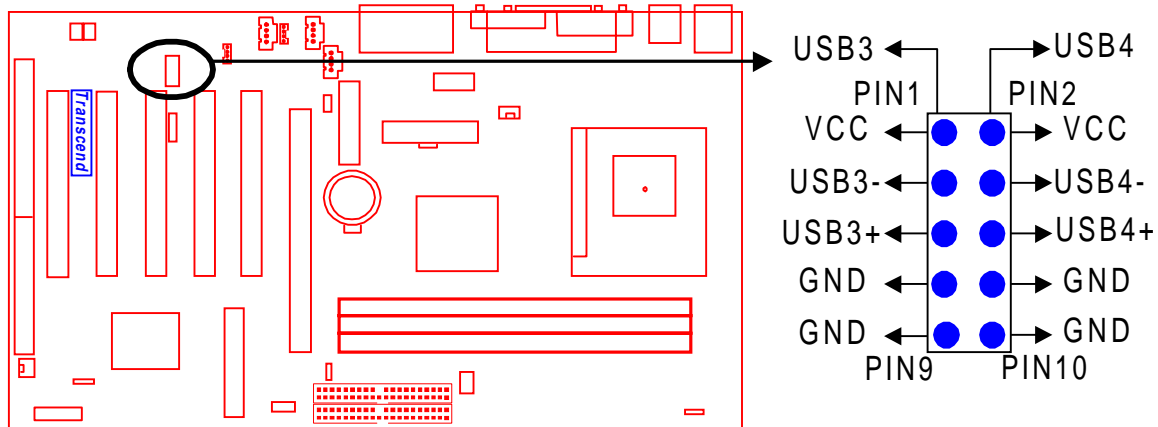

Internal USB Port Connector

2.21 VIO Adjust Jumper (3-pin JP5)

This function allows you to increase VCC3 Voltage for heavy loading.

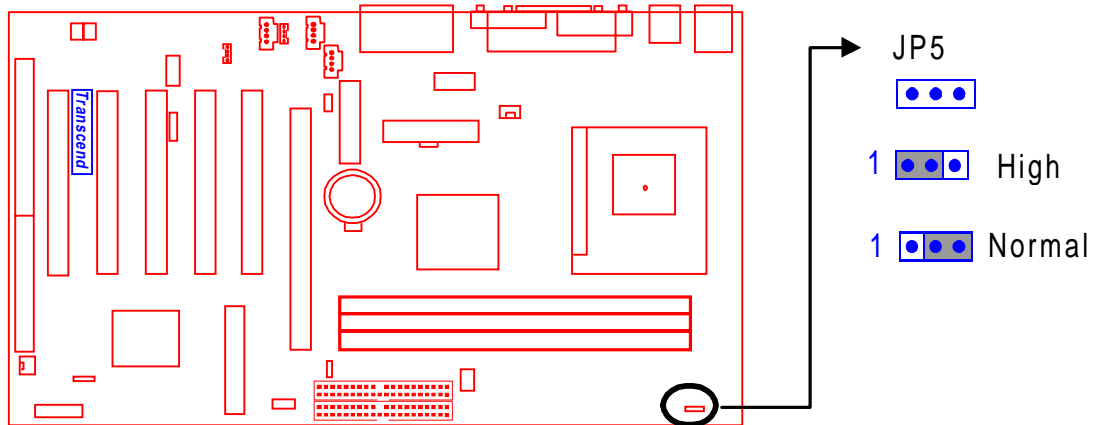

VIO Adjust Jumper

Congratulations! You have now completed Hardware Setup! This means that you can move on to Chapter 3, the BIOS Setup section and turn on your PC.

CHAPTER 3 BIOS SETUP

3.1 BIOS Setup

Award BIOS has a built-in Setup program that allows users to modify the basic system configuration. This information is stored in CMOS RAM, so it can retain the Setup information when the power is turned off. When the CMOS battery fails, it will cause the data to be lost. If that happens, please set up your configuration parameters again after replacing the battery. Please refer to Section 1.1, Essential Handling Precautions (Page 1).

3.2 The Main Menu

As you turn on or reboot the system, the BIOS is immediately activated. It will read the system configuration information, and check the system through The Power On Self Test (POST). During the POST process, press the [Del] key, and you can enter the Award BIOS configuration system. The following screen will appear.



In the Award BIOS system, you can use the arrows (↑ ↓ → ←) to highlight an item, and press the [Enter] key to enter the sub-menu. The following keys help you navigate in Setup.

[Esc] Main Menu: Quit and do not save changes into CMOS RAM

Other pages: Exit current page and return to Main Menu

[PgUp] Increase the numeric value or make changes

[PgDn] Decrease the numeric value or make changes

- [+] Increase the numeric value or make changes
- [-] Decrease the numeric value or make changes
- [F1] General help on setup navigation keys
- [F5] Load previous values from CMOS
- [F6] Load the Fail-Safe Defaults from BIOS default table
- [F7] Load the Optimized Defaults
- [F10] Save all CMOS changes, and exit

The following is a brief summary of each setup category

- **Standard CMOS Features**

Options in the original PC AT-compatible BIOS

- **Advanced BIOS Features**

Award enhanced BIOS options

- **Advanced Chipset Features**

Available options specific to your system Chipset

- **Integrated Peripherals**

I/O subsystems that depend on the integrated peripheral controllers in your system

- **Power Management Setup**

Advanced Power Management (APM) and Advanced Configuration and Power Interface (ACPI) options

- **PnP/PCI Configurations**

Plug and Play standard and PCI Local Bus configuration options

- **PC Health Status**

To display the fan status, CPU temperature, system temperature etc., and to provide the temperature monitoring option

- **Frequency / Voltage Control**

To control the frequency and voltage of the CPU

- **Load Fail-Safe Defaults**

To load the most basic BIOS default values required for your system to operate

- **Load Optimized Defaults**

To load the BIOS default values that are factory settings for optimal system performance

- **Set Supervisor / User Password**

To change, set, or disable a password

- **Save & Exit Setup**

To save settings in nonvolatile CMOS RAM and exit Setup

- **Exit Without Saving**

To abandon all changes and exit Setup

3.3 Standard CMOS Features



- **Date (mm:dd:yy) / Time (hh:mm:ss)**

Highlight the items and use [PageUp] / [PageDown] to change the value of Date/Time.

- **IDE Primary / Secondary Master / Slave**

Press [Enter] to enter the sub menu.

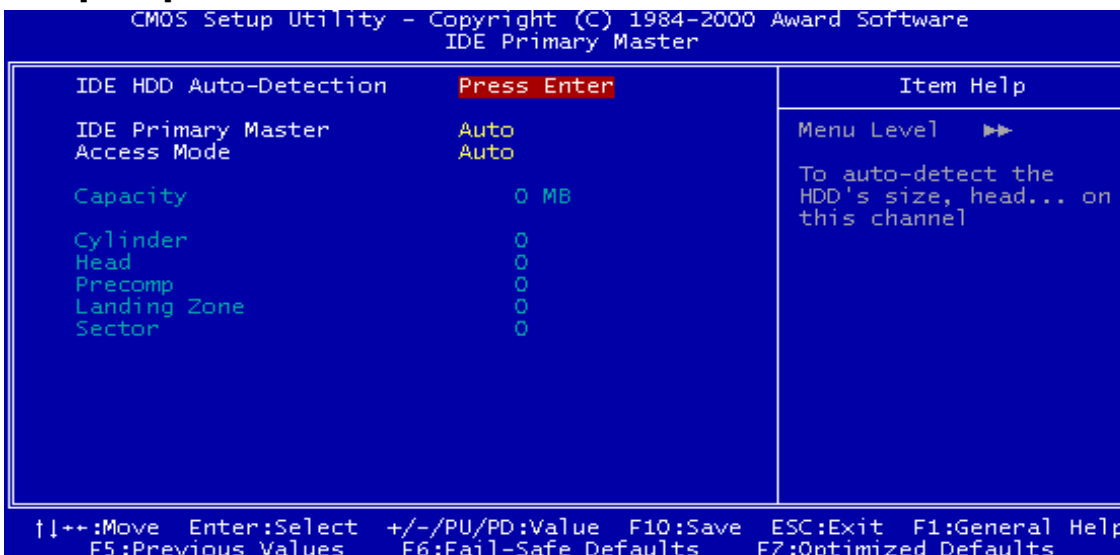

- IDE HDD Auto-Detection: Detect the HDD on this channel. If the detection is successful, it fills the remaining fields on this menu.
 - IDE Primary/Secondary Master/Slave: We recommend that you select “AUTO” for all drives. The BIOS can automatically detect the specifications during POST (Power On Self Test) while the system boots. You can also choose “Manual” to set the specifications by yourself. The “None” setting means there is no device installed on this IDE channel.
 - Access Mode: “Normal”, “LBA”, “Large”, or “Auto”.
 - Normal: Maximum number of cylinders, heads, and sectors supported are 1024, 16, and 63 respectively.
 - LBA (Logical Block Addressing): During drive access, the IDE controller transfers the data address described by sector, head, and cylinder number into a physical block address. This will significantly improve data transfer rates for drives with more than 1024 cylinders.
 - Large: For drives that do not support LBA and have more than 1024 cylinders.
 - Auto: The BIOS automatically determines the optimal access mode.
 - Capacity: Disk drive capacity. Note that this size is slightly greater than the size of a formatted disk given by the disk-checking program.
 - Cylinder: Number of cylinders
 - Head: Number of heads
 - Precomp: Write precompensation cylinder
 - Landing Zone: Landing zone
 - Sector: Number of sectors
-

• Drive A / Drive B

Select the correct types of diskette drive(s) installed in the computer.

- None: No diskette drive installed
- 360K, 5.25 in.: 5-1/4 inch standard drive; 360 KB capacity
- 1.2M, 5.25 in.: 5-1/4 inch high-density drive; 1.2 MB capacity
- 720K, 3.5 in.: 3-1/2 inch double-sided drive; 720 KB capacity
- 1.44M, 3.5 in.: 3-1/2 inch double-sided drive; 1.44 MB capacity
- 2.88M, 3.5 in.: 3-1/2 inch double-sided drive; 2.88 MB capacity

• Video

Select the type of primary video subsystem in your computer. The BIOS will detect the correct video type automatically. The BIOS supports a secondary video subsystem, but do not select it in this Setup.

- EGA/VGA: Enhanced Graphics Adapter/Video Graphics Array. For EGA, VGA, SEGA, SVGA or PGA monitor adapters.
- CGA 40: Color Graphics Adapter, powers up in 40-column mode.
- CGA 80: Color Graphics Adapter, powers up in 80-column mode.
- MONO: Monochrome adapter, including high resolution.

• Halt On

During the Power On Self Test (POST), the computer stops if the BIOS detects a hardware error. You can set the BIOS to ignore certain errors during POST and continue the boot-up process. The followings are the selections.

- All Errors: If the BIOS detects any non-fatal errors, POST stops and prompts you to take corrective action.
 - No Errors: POST does not stop for any error.
 - All, But Keyboard: If the BIOS detects any non-fatal errors except keyboard, POST stops and prompts you to take corrective action.
-

3.4 Advanced BIOS Features

The “Advanced BIOS Features” option allows you to improve your system performance and sets up system features according to your preference.



- **Virus Warning**

When this function is enabled, you will receive a warning message if a program (specifically, a virus) attempts to write to the boot sector or the partition table of the hard disk drive. You should then execute an anti-virus program. Keep in mind that this feature protects the boot sector only, not the entire hard drive.

NOTE: Many disk diagnostic programs that access the boot sector table can trigger the virus warning message. If you plan to run such a program, we recommend that you first disable this virus warning.

- **CPU Internal Cache/External Cache**

Cache memory is additional memory that is much faster than conventional DRAM (system memory). CPUs from 486-type and up contain internal cache memory. Most, but not all, modern PCs have additional (external) cache memory. When the CPU requests data, the system transfers the requested data from the main DRAM into cache memory for even faster access by the CPU. The “External Cache” field may not appear if your system does not have external cache memory.

- **CPU L2 Cache ECC Checking**

Select “Enabled” to make sure the data is accurate.

- **Processor Number Feature**

This function was designed with the internet in mind. Select “Enable” to make the processor serial number serve as a means of identifying your system.

- **Quick Power On Self Test**

Select “Enabled” to reduce the amount of time required to run the Power On Self Test (POST). The Quick POST skips certain steps. We recommend that you normally disable Quick POST. It’s better to find a problem during POST than to lose data during your work.

- **First/Second/Third Boot Device; Boot Other Device**

The original IBM PCs loaded the DOS operating system from drive A (floppy disk). Therefore, IBM PC-compatible systems are designed to search for an operating system first on drive A, and then on drive C (hard disk). However, the BIOS attempts to load the operating system from the devices in the sequence selected in these fields. In addition to the traditional drives A (“Floppy”) and C (“HDD-0”), options include “HDD-1”, “HDD-2”, “HDD-3”, and “CD-ROM”; plus a “SCSI” hard drive, a “LS/ZIP” drive and a “LAN” drive. If your boot device is not included in the list, you can set the “Boot Other Device” field to “Enabled”, and let the system detect the drive automatically.

- **Swap Floppy Drive**

This field is effective only in systems with two floppy drives. Selecting “Enabled” assigns physical drive B to logical drive A, and physical drive A to logical drive B.

- **Boot Up Floppy Seek**

When you select “Enabled”, the BIOS tests (seeks) floppy drives to determine whether they have 40 or 80 tracks. Only 360-KB floppy drives have 40 tracks; drives with 720KB, 1.2MB, and 1.44MB capacity all have 80 tracks. Because very few modern PCs have 40-track floppy drives, we recommend that you set this field to “Disabled” to save time.

- **Boot Up NumLock Status**

Toggle between “On” and “Off” to control the state of the NumLock key when the system boots. When toggled “On”, the numeric keypad generates numbers instead of controlling cursor operations.

- **Gate A20 Option**

Choose “Fast” (default) or “Normal”. “Fast” allows RAM access above 1MB to use the fast Gate A20 line.

- **Typematic Rate Setting**

When this function is disabled, the following two items (Typematic Rate and Typematic Delay) are irrelevant. Keystrokes repeat at a rate determined by the keyboard controller in your system. When this function is enabled, you can select a typematic rate and typematic delay.

- **Typematic Rate (Chars/Sec)**

When the Typematic Rate setting is enabled, you can select a typematic rate (the rate at which characters repeat) to “6”, “8”, “10”, “12”, “15”, “20”, “24” or “30” characters per second.

- **Typematic Delay (Msec)**

When the Typematic Delay setting is enabled, you can select a typematic delay (the delay before key strokes begin to repeat) of “250”, “500”, “750” or “1000” milliseconds.

- **Security Option**

If you have set a password, you can select whether the password is required while the system boots, or only when you enter “Setup”.

- **OS Select for DRAM > 64MB**

Select "OS2" only if you are running the OS/2 operating system with more than 64 MB of RAM on your system.

- **Video BIOS Shadow**

Select "Enabled" to change the video BIOS location from ROM to RAM, where the CPU can read data through the 64-bit DRAM bus. This can enhance system performance.

- **C8000-DFFFF Shadow**

You can shadow the ROM on other expansion cards by setting these fields. If you install other expansion cards with ROMs, you need to know which address the ROMs use specifically. Shadowing a ROM reduces the memory available between 640K and 1024K depending on the used amount.

3.5 Advanced Chipset Features

This option will change the values of the chipset registers and the system setting will alter. Do not change any values if you are unfamiliar with the chipset.



- **DRAM Timing By SPD**

The DRAM timing is determined by the SPD of Memory modules which are plugged on the motherboard.

- **DRAM Clock**

Set the clock frequency of the DRAMs. The default value is "Host Clock". You can select "HCLK+33M" if your DRAM modules are faster than the CPU (a 66 MHz FSB CPU with a PC100 SDRAM, or a 100 MHz FSB CPU with PC133 SDRAM); or select "HCLK-33M" for a faster CPU with slower SDRAMs.

- **SDRAM CAS Latency**

This controls the SDRAM performance, default is "3" clocks. If your SDRAM DIMM specification is 2 CAS latency, change "3" to "2" for better performance.

- **Bank Interleave**

This function allows you to enhance the DRAM timing.

- **Memory Hole**

Enabling this feature reserves memory address space (between 15 and 16MB) to ISA expansion cards that specifically require this setting. This makes between 15 and 16MB of memory unavailable to the system. Expansion cards can only access memory up to 16MB. The default setting is “Disabled”.

- **CPU/PCI Concurrency**

When “Disabled”, the CPU bus will be occupied during the entire PCI operation period.

- **Fast R-W Turn Around**

DRAM optimization feature: If a memory read is addressed to a location whose latest write is being held in a buffer before being written to memory, the read is satisfied through the buffer contents, and the read is not sent to the DRAM.

The choices: “Enabled” and “Disabled”.

- **System BIOS Cacheable**

Selecting “Enabled” allows caching of the system BIOS. This action can increase system performance.

- **Video RAM Cacheable**

Selecting “Enabled” allows caching of the video RAM. This action can increase system performance.

- **Frame Buffer Size**

This item allows you to control the internal VGA frame buffer size (NA/4M/8M/16M/32M).

- **AGP Aperture Size (MB)**

Memory-mapped graphics data structures can reside in a Graphic Aperture. We suggest you leave this field on the default setting.

- **AGP- 4X Mode**

Select “Enable” if you use a AGP-4X VGA card.

- **AGP Driving Control**

This function allows you to adjust the AGP driving force. Choosing ‘Manual’ allows you key in an AGP Driving Value in the next selection. We recommend that you set this field to “Auto” to avoid any error in the system.

- **AGP Driving Value**

This field allows you to adjust the AGP driving force (from 00~FF).

- **OnChip USB**

Select “Enabled” if you have a USB Keyboard or any USB device.

- **USB Keyboard Support**

Select “Enabled” if you want to use a USB Keyboard.

- **USB Mouse Support**

Select “Enabled” if you want to use a USB Mouse.

- **On Chip Sound**

Select “Auto” to enable the OnChip Audio Controller, which lets you use OnBoard CODEC or Add-On CODEC on the AMR card (depends on the JP setting). If you use an Add-On Audio Card with an Audio Controller built-in, please set this field to “Disabled”.

- **OnChip MODEM**

Select “Auto” to enable the OnChip MODEM Controller, which lets you use Add-On MODEM CODEC on the AMR card. If you use an Add-On card with a MODEM Controller built-in, please set this field to “Disabled”.

- **CPU to PCI Write Buffer**

If “Enabled” is selected, writes from the CPU to the PCI bus are buffered to compensate for the speed differences between the CPU and the PCI bus. If “Disabled”, the writes are not buffered and the CPU must wait until the write is complete before starting another write cycle.

- **PCI Dynamic Bursting**

When “Enabled”, every write transaction goes to the write buffer. Burstable transactions then burst on the PCI bus and nonburstable transactions will write to PCI bus immediately.

- **PCI Master 0 WS Write**

When “Enabled”, writes to the PCI bus are executed with zero wait states.

- **PCI Delay Transaction**

The chipset has an embedded 32-bit posted write buffer to support delay transactions cycles. Select “Enabled” to support compliance with PCI specification version 2.1.

- **PCI #2 Access #1 Retry**

Select “Enabled” to support PCI #2 (AGP bus) access to PCI #1 (PCI bus) retry function when an error occurred. The default value is “Disabled”.

- **AGP Master 1 WS Write**

Selecting “Enabled” will implement a single delay when writing to the AGP Bus. By default, two wait states are used by the system, allowing for greater stability.

- **AGP Master 1 WS Read**

This implements a single delay when reading to the AGP Bus. By default, two-wait states are used by the system, allowing for greater stability.

3.6 Integrated Peripherals

Choose this option and the following display appears.



- **On-Chip IDE Channel 0/1**

The chipset contains a PCI IDE interface which supports two IDE channels. Select “Enabled” to activate the first and/or second IDE interface. Select “Disabled” to deactivate this interface, if you install a primary and/or secondary add-in IDE interface.

- **IDE Prefetch Mode**

The On Board IDE drive interface supports IDE prefetching for faster drive access. If your IDE drive has add-in IDE interface and doesn’t support prefetching, please set this field to “Disabled”.

- **Primary/Secondary Master/Slave PIO**

The four IDE PIO (Programmed Input/Output) fields let you set a PIO mode (0-4) for each of the four IDE devices that the onboard IDE interface supports. Mode 0 through 4 provide successively increased performance. In “Auto” mode, the system automatically determines the best mode for each device.

- **Primary/Secondary Master/Slave UDMA**

Ultra DMA33(66) implementation is possible only if your IDE hard drive can support it and the operating environment includes a DMA driver (Windows 95 OSR2 or a third-party IDE bus master driver). If both your hard disk drive and your system software can support Ultra DMA33(66), select “Auto” to enable BIOS support.

- **Init Display First**

This item allows you to decide whether to activate either the “PCI ” or the “AGP” first.

- **IDE HDD Block Mode**

Block Mode is also called Block Transfer, Multiple Commands, or Multiple Sector Read/Write. If your IDE hard drive supports Block Mode (most new drives do), select “Enabled” for automatic detection of the optimal number of Block Read/Writes per sector that the drive can support.

- **Onboard FDD Controller**

You can use this function to enable or disable the onboard FDD controller.

- **Onboard Serial Port 1/Port 2**

Select an address and the corresponding interrupt for each of the first and second serial ports. The Choices are: “Disabled”, “3F8/IRQ4”, “2F8/IRQ3”, “3E8/IRQ4”, “2E8/IRQ3”, and “Auto”. **The second serial port shares the resources (address and IRQ) with IrDA.**

- **UART 2 Mode**

Choose the right type of infrared device:

- Standard : Normal operation
- HPSIR : IrDA compliant serial infrared port
- ASKIR : Amplitude Shift Keyed Infrared Port

- **IR Function Duplex**

Consult your IR peripheral documentation to select the setting for IR “Half” / ”Full” duplex function.

- **TX, RX Inverting Enable**

Consult your IR peripheral documentation to set this field. The item “Yes” means “Low Active” and “No” means “High Active”.

- **Onboard Parallel Port**

Select a logical LPT port name and matching address for the physical parallel (printer) port.

The choices are: “378/IRQ7”, “278/IRQ5”, “3BC/IRQ7” and “Disabled”.

- **Onboard Parallel Mode**

This field allows you to set the operation mode of the parallel port.

- Normal: Allows normal-speed operation, but in one direction only.
- EPP: Allows bidirectional parallel port operation at maximum speed.
- ECP: Allows DMA and bidirectional operation. It is faster than EPP mode.
- ECP + EPP: Allows normal speed operation in two-way mode.

- **ECP Mode Use DMA**

Assign DMA channel “1” or “3” to the port for ECP mode operation.

- **Parallel Port EPP Type**

Select EPP port type “1.7” or “1.9”.

- **Onboard Legacy Audio**

This field controls the onboard legacy audio related selection. If “Disabled” all of the following selections will be disabled. Select “Enable” if you want to use onboard audio.

- **Sound Blaster**

Select “Enable” to use Sound Blaster.

- **SB I/O Base Address**

Assign Sound Blaster resources. We recommend you leave this field on default.

- **SB IRQ Select**

Assign Sound Blaster resources. We recommend you leave this field on default.

- **SB DMA Select**

Assign Sound Blaster resources. We recommend you leave this field on default.

- **MPU-401**

Select “Enabled” to use the MPU-401 device (Hardware Wave Table) you installed.

- **MPU-401 I/O Address**

Assign MPU-401 resource.

- **Game Port (200-207H)**

Select "Enabled" to assign Game Port resource.

3.7 Power Management Setup

The Power Management Setup allows you to configure your system to minimize energy consumption, according to your own style of computer use.

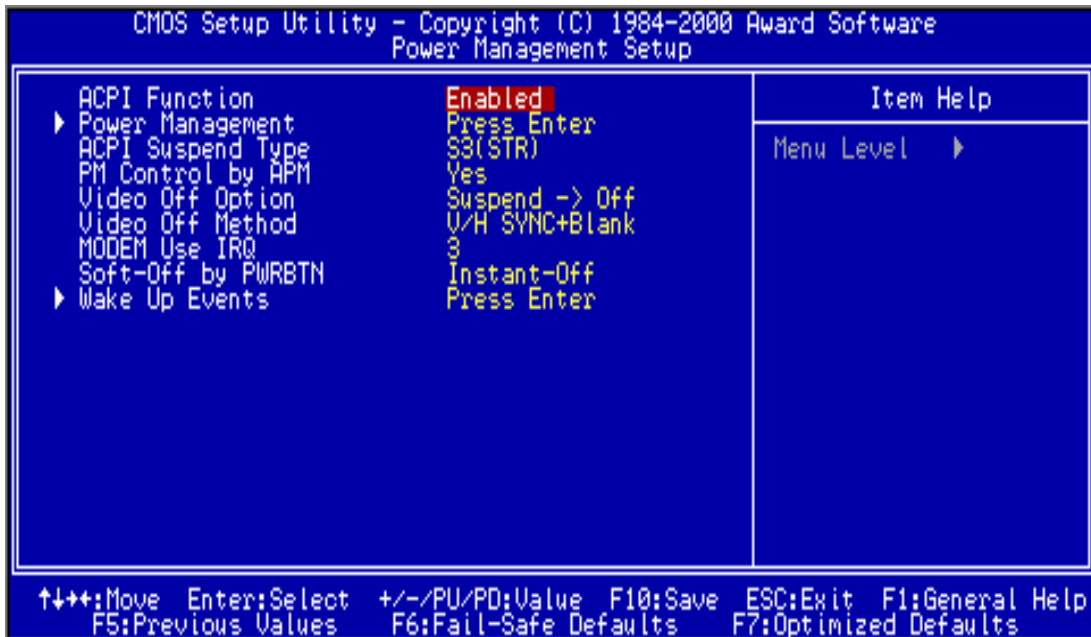

- **ACPI Function**

This item allows you to enable/disable the Advanced Configuration and Power Interface (ACPI).

- **Power Management**

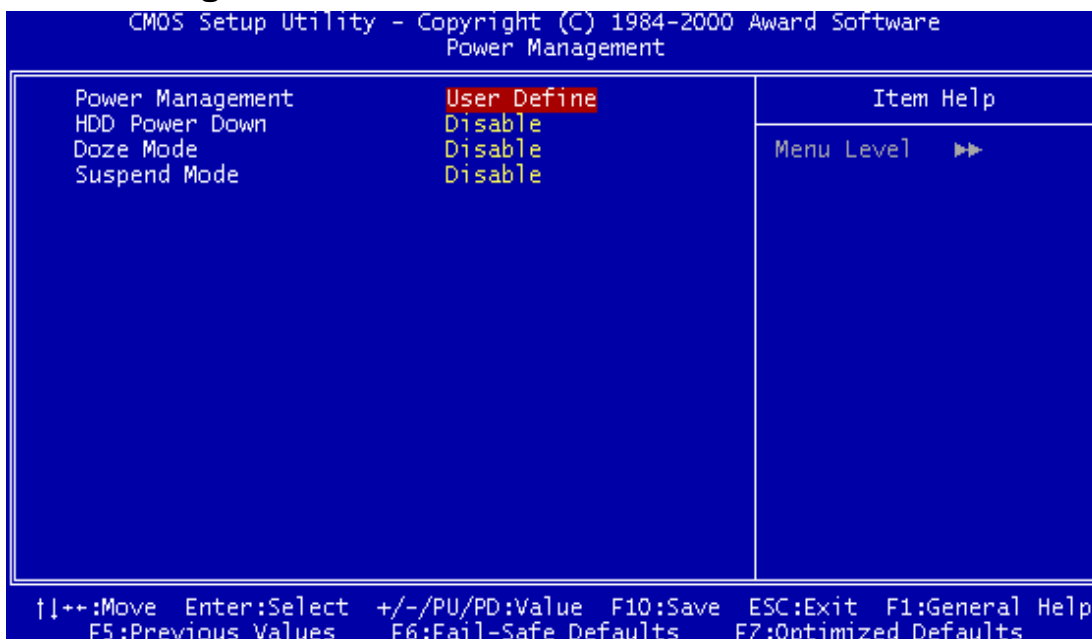

This category allows you to select the type (or degree) of power saving and is directly related to the following modes.

1. Suspend Mode
2. HDD Power Down
3. Doze Mode

There are three selections for Power Management. Two of them have fixed mode settings.

1. Min. Power Saving :

Minimum power management mode. Inactivity period is defined below:

Doze Mode = 1 Hour

Suspend Mode = 1 Hour.

2. Max. Power Saving :

Maximum power management mode. Inactivity period is defined below:

Doze Mode = 1 Min

Suspend Mode = 1 Min.

3. User Define :

Allows you to set each mode individually. Select the time-out period for each mode shown above.

• ACPI Suspend Type

Select the ACPI Suspend Type : “S1 (POS)” or “S3 (STR)”.

If your expansion cards do not support the STR function, you must leave this field on “S1 (POS)” setting. STR (Suspend-to-RAM) is an energy-saving feature. It takes only a few seconds to wake up the system and return H to its previous situation.

NOTE: This feature (STR) requires an ATX power supply with at least 720mA and 5V standby power for the Advanced Configuration and Power Interface (ACPI) functions. Otherwise, the system will fail to return from suspend mode.

• PM Control by APM

When “Yes”, an Advanced Power Management device will be activated to enhance the Max. Power Saving mode and stop the CPU internal clock.

- **VIDEO Off Option**

When “Enabled”, this function allows the VGA adapter to operate in a power saving mode.

-Always On: Monitor will remain on during power saving modes.

-Suspend Off: Monitor blanked when the system enters the suspend mode.

-All Modes: Monitor blanked when the system enters any power saving mode.

- **Video Off Method**

Defines the Video Off features

-Blank Screen: Only blanks the screen. Use this for monitors without power management and “green” features.

-V/H SYNC+Blank: Blanks the screen and turns off vertical and horizontal scanning

-DPMS Support: The DPMS (Display Power Management System) feature allows the BIOS to control the video display card if it supports the DPMS feature.

- **MODEM Use IRQ**

You can select one of the following interrupt resources for modem use: “N/A”, “3”, “4”, “5”, “7”, “9”, “10”, and “11”.

- **Soft-Off by PWRBTN**

When set to “Instant-off”, the ATX switch can be used as a normal system Power Off button.

When set to “Delay 4 seconds”, you need to press the ATX switch down for more than 4 seconds if you want to Power Off the system.

- **State After Power Failure**

State After Power Failure

-On: After a power failure, the system will automatically reboot as soon as power is restored.

-Off: After a power failure, the system will not reboot when power is restored. The system needs to be turned on again manually.

-Auto: After a power failure, the system will automatically reboot as soon power is restored if the PC was turned on when the power failed. If the PC was already turned off when the power failed, the system needs to be turned on again manually.

- Wake Up Events

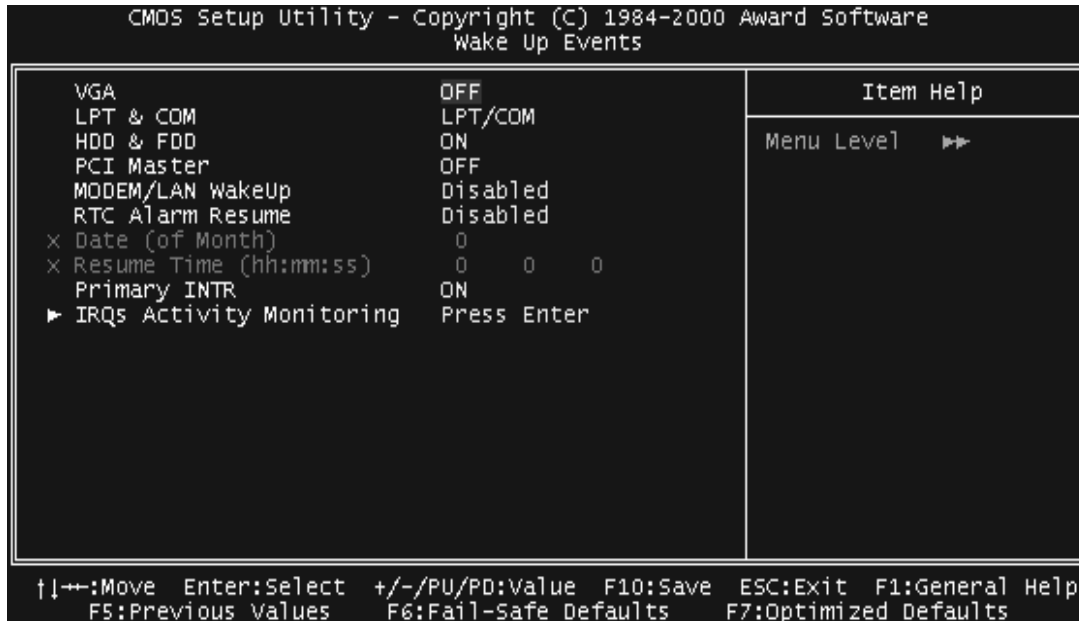

- **VGA**

If you select “On”, you can set the VGA to awake the system.

- **LPT & COM**

Any activity “LPT” from “LPT”, “COM” or “LPT/COM” wakes up the system.

- **HDD & FDD**

If you select “On”, any activity from one of them wakes up the system.

- **PCI Master**

If select “On”, any activity on PCI Master wakes up the system.

- **MODEM/LAN Wake-Up**

Select “Disabled” to Power On your system when the external modem receives a call.

NOTE: This function requires an external modem which supports the Ring Wake-Up function.

- **RTC Alarm Resume**

Select “Disabled” if you want to Power On your system at a certain time on the same day every month or at a certain time every day.

- **Resume Date/Time**

Set the Date and Time to Power On the system. Activated only when the “Resume by Alarm” field is enabled.

- **Primary INTR**

If you select “On”, the IRQs Activity Monitor Function will be enabled,

- **IRQs Activity Monitoring**

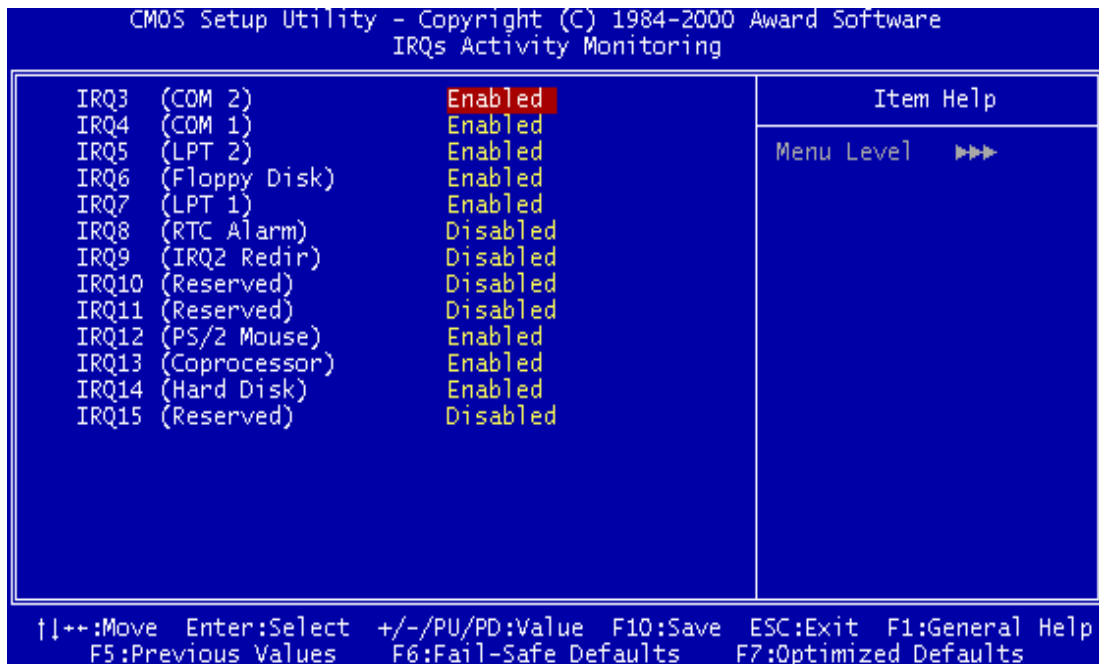

In the screen, you can see a list of IRQs (Interrupt Requests),

When an I/O device wants to gain the attention of the Operating System, it asserts an IRQ signal. When the Operating System is ready to respond to the request, it interrupts itself and performs the service.

The IRQs Activity Monitoring function monitors the IRQs you select “On”, any activity from one of them will awaken a system which has been powered down.

3.8 PnP/PCI Configurations

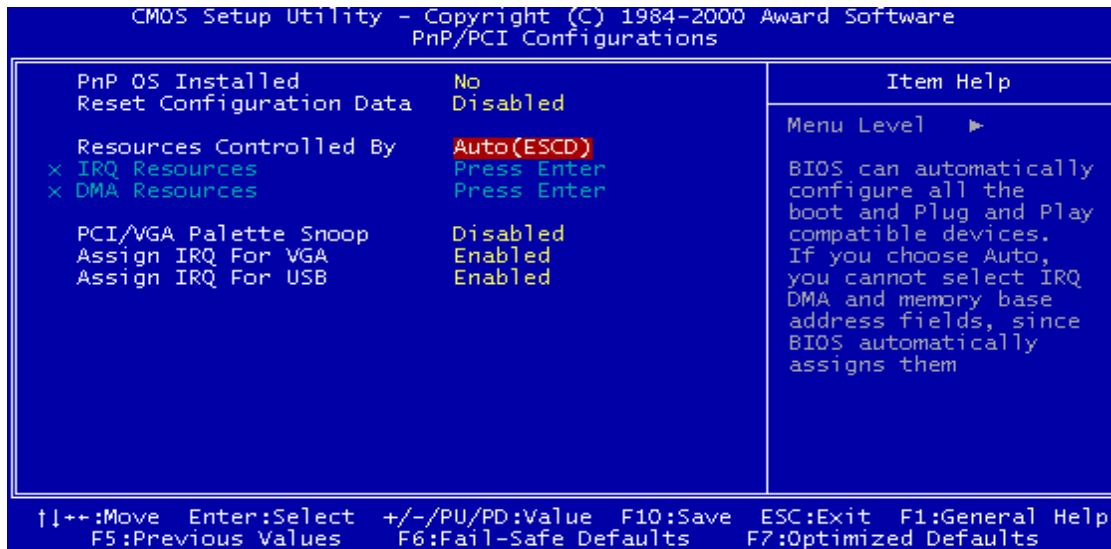

- **PnP OS Installed**

This field allows you to use a Plug-and-Play (PnP) operating system to configure the PCI bus slots instead of using the BIOS. Thus interrupts may be re-assigned by the OS when “Yes” is selected. When a non-PnP OS is installed to prevent re-assigning of interrupt settings, select the default setting of “No”.

- **Reset Configuration Data**

Normally, you leave this field on “Disabled”. Select “Enabled” to reset Extended System Configuration Data (ESCD), if you have just installed a new add-on card and the system reconfiguration has caused such a serious conflict that the operating system cannot boot. The setting will automatically be set back to “Disabled” when the system reboots.

- **Resources Controlled by**

The Award Plug and Play BIOS can automatically configure all the boot and Plug and Play (PnP) compatible devices. If you select “Auto(ESCD)”, all of the Interrupt Requests (IRQs) and DMA assignment fields will be deactivated as the BIOS automatically assigns them.

• IRQ Resources

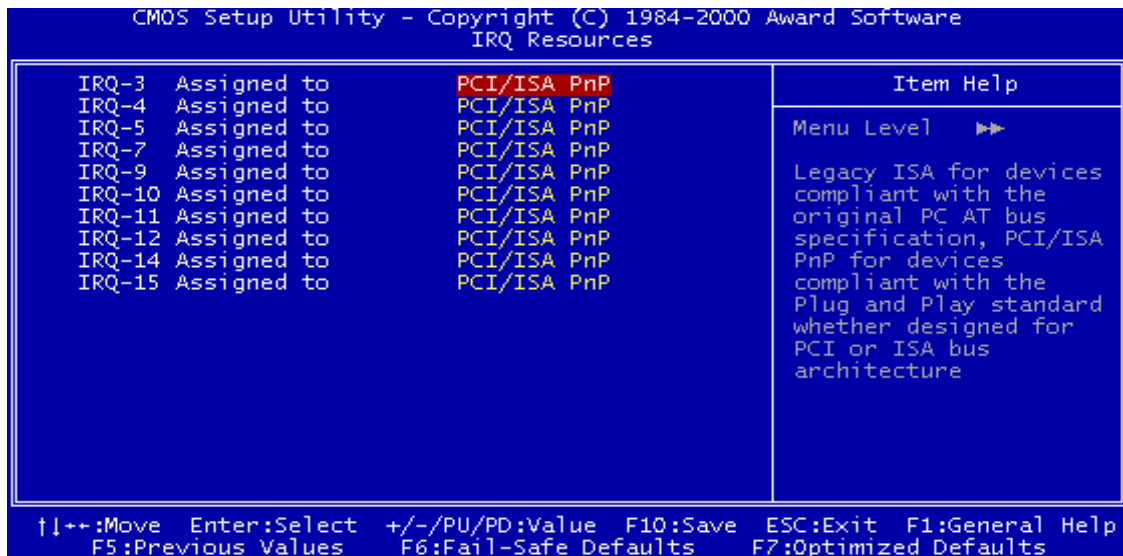

• IRQ-n Assigned to

When the resources are controlled manually, assign each system interrupt to one of the following, depending on which type of device is using the interrupt.

- PCI/ISA PnP devices, whether designed for PCI or ISA bus architecture, compliant with the Plug and Play standard.
- Legacy ISA Devices, requiring a specific interrupt (such as IRQ4 for serial port1), compliant with the original PC AT bus specification.

• DMA Resources

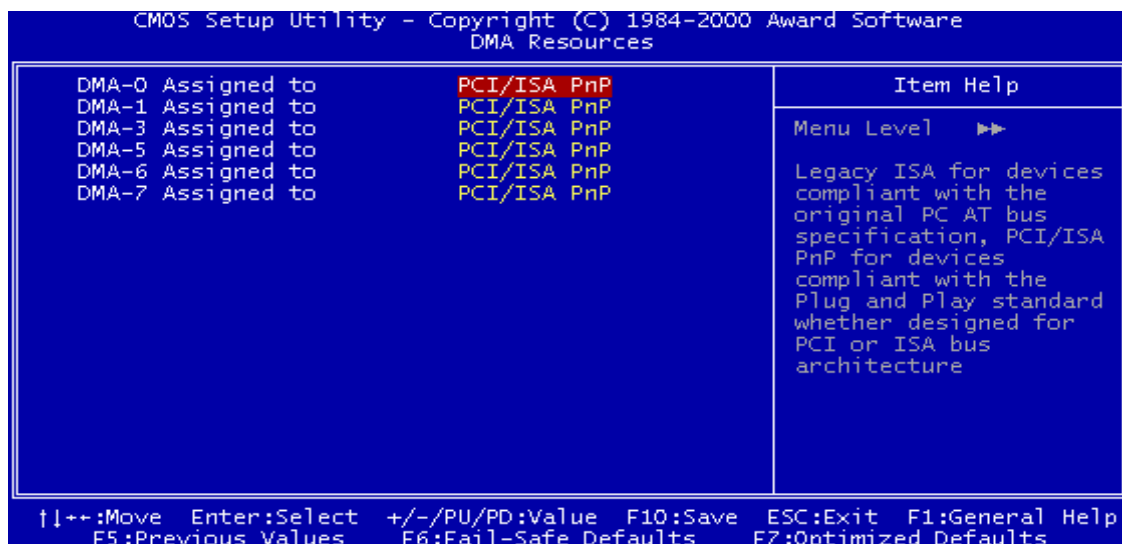

- **DMA-n Assigned to**

Just as the IRQ Resource Assignment, you can assign DMA Resources manually.

- **PCI/VGA Palette Snoop**

Some VGA cards, such as graphics accelerators or MPEG video cards, might not show colors properly. Select “Enabled” to correct this problem. If you don’t have such problems, leave this field at “Disabled”.

- **Assign IRQ For VGA**

Select “Enabled” only if your VGA card requires an assigned IRQ. Most ordinary cards do not, but some high-end cards with video capture function do. Consult your VGA documentation to set this field. Activity of the selected IRQ always awakens the system

- **Assign IRQ For USB**

When “Enabled”, BIOS will assign an IRQ channel for the USB controller.

3.9 PC Health Status

This menu provides two thermo-protect functions (CPU warning temperature and shutdown temperature) and a hardware monitor center. These features let you know the health status of your PC.

```

CMOS Setup Utility - Copyright (C) 1984-2000 Award Software
PC Health Status
-----
Current CPU Temperature      34C / 93CF
Current System Temperature  29C / 84CF
Current CPU12 FAN Speed     5043RPM
Current SYS FAN Speed       0 RPM
Vcore                        2.54V
+5V                           5.00V
+3.3V                          3.30V
+12V                          12.30V
-----
Item Help
Menu Level  ▶
-----
↑↓↓+:Move  Enter:Select  +/-/PU/PD:Value  F10:Save  ESC:Exit  F1:General Help
F5:Previous Values  F6:Fail-Safe Defaults  F7:Optimized Defaults

```

- **Current CPU Temperature**

This field displays the current CPU temperature.

- **Current System Temperature**

This field displays the current system temperature.

- **Current CPU/SYS Fan Speed**

These fields display the fan speeds of the CPU and SYS cooling fans.

- **System Voltage Monitor**

These fields display the CPU core voltage (Vcore),+2.5V,+3.3V,+5V and +12V.

3.10 Frequency/Voltage Control

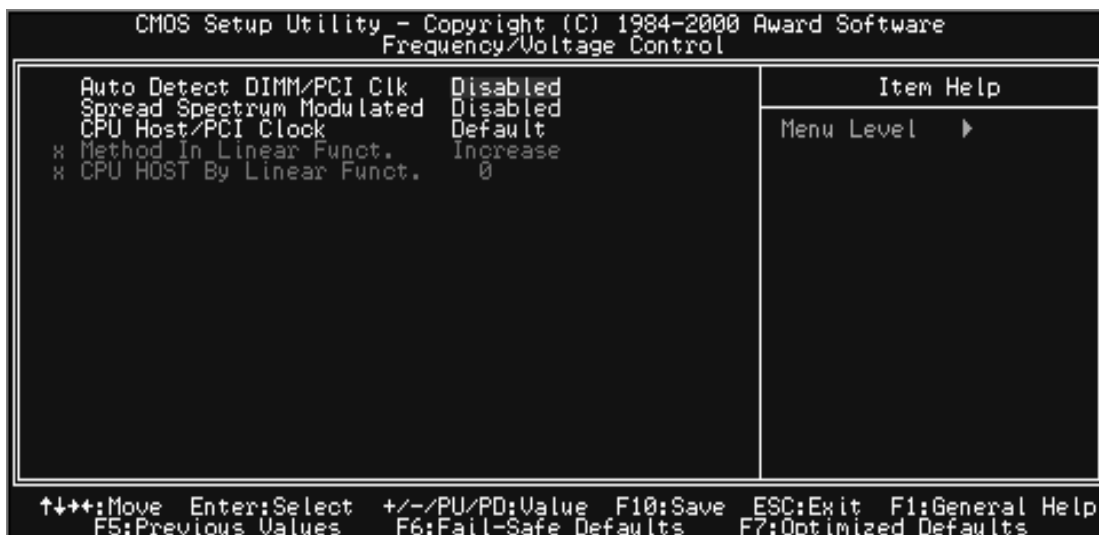

- **Auto Defect DIMM/PCI Clk**

“Enable” can stop the frequency output for unused DIMM / PCI slots.

- **Spread Spectrum**

“Enable” provides spread Spectrum for better EMI solution.

- **CPU Host/PCI Clock**

This function allows you to set the FSB frequency of the CPU and the speed of the PCI bus. When SW2 is set to 66 MHz, you can select a system bus and PCI bus frequency from 66/33 MHz to 95/31 MHz. When SW2 is set to 100 MHz, you can select a system bus frequency from 100/33 MHz to 124/31 MHz. When SW2 is set to 133 MHz, you can select a system bus and PCI bus frequency from 133/33 MHz to 150/37 MHz.

3.11 Load Fail-Safe Defaults

This option allows you to load the troubleshooting default values permanently stored in the BIOS ROM.

NOTE: These default settings are non-optimal and disable all high performance features.

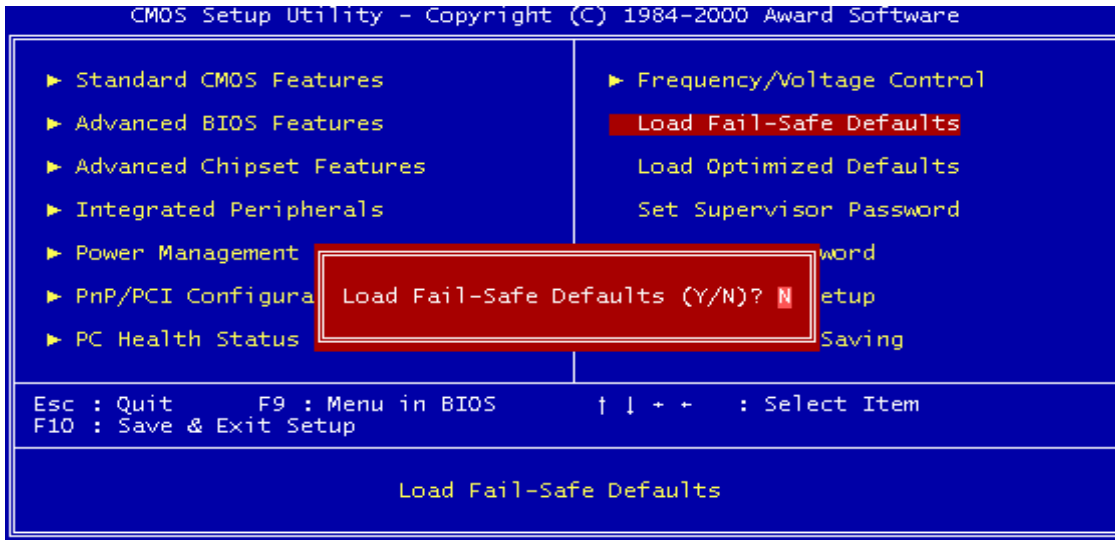

3.12 Load Optimized Defaults

This option allows you to load the default values to the system configuration fields. These default values are the optimized configuration settings for the system.

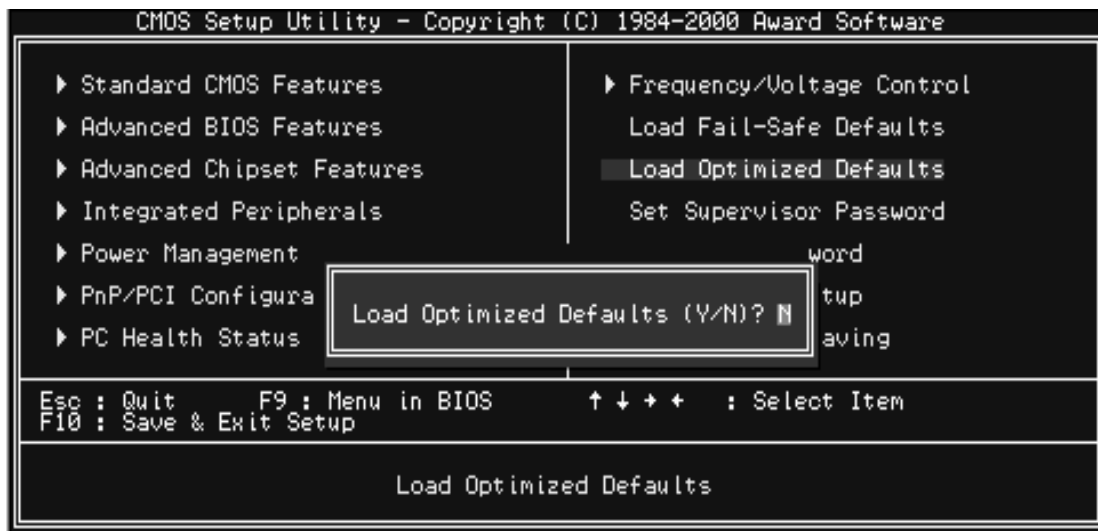

3.13 Supervisor Password

This option allows you to set a password to prevent others from changing the BIOS setting of your system.

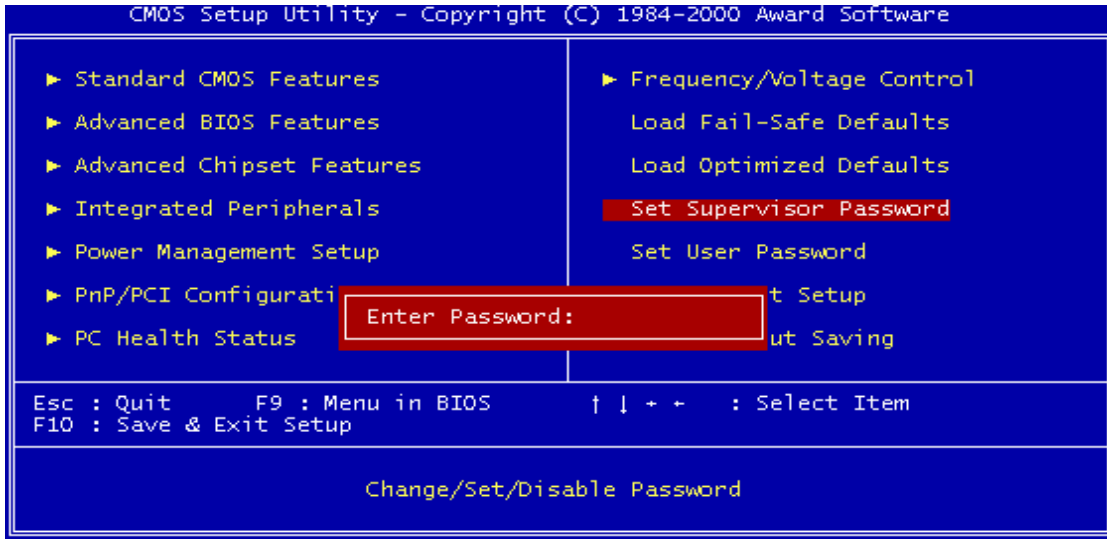

The password prevents any unauthorized use of your computer. If you set a password, the system prompts for the correct password before you boot or access “Setup”.

To set a password:

1. At the prompt, type your password. Your password can be up to 8 alpha-numeric characters. When you type the characters, they appear as asterisks on the password screen box.
2. After typing the password, press the [Enter] key.
3. At the next prompt, re-type your password and press the [Enter] key again to confirm the new password. After password entry, the screen automatically reverts to the main menu screen.

To disable the password, press the [Enter] key when prompted to enter the password. The screen displays a message confirming that the password has been disabled.

Forget the password?

If you forget the password, you can clear it by erasing the CMOS Real Time Clock (RTC) RAM with jumper 4 (JP4: CMOS_CLR. Please refer to page 19). To erase the RTC RAM:

1. Unplug your computer.
2. Short the JP4 jumper 2-3, then return to 1-2.
3. Turn on your computer.
4. Hold down [Delete] key during the POST process and enter BIOS setup to re-configure BIOS.

3.14 User Password

This option allows you to set a password to prevent others from changing the BIOS setting of your system. This operation is the same as Supervisor Password.



3.15 Save & Exit Setup

Save the settings and exit the BIOS utility.

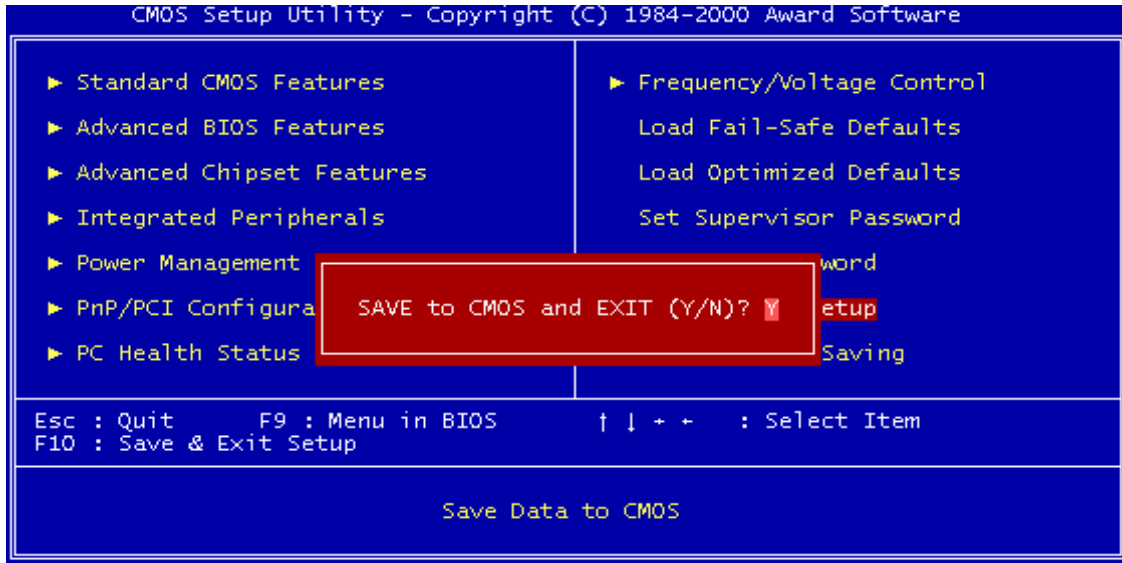

3.16 Exit Without Saving

Abort the current changes and exit the BIOS utility.

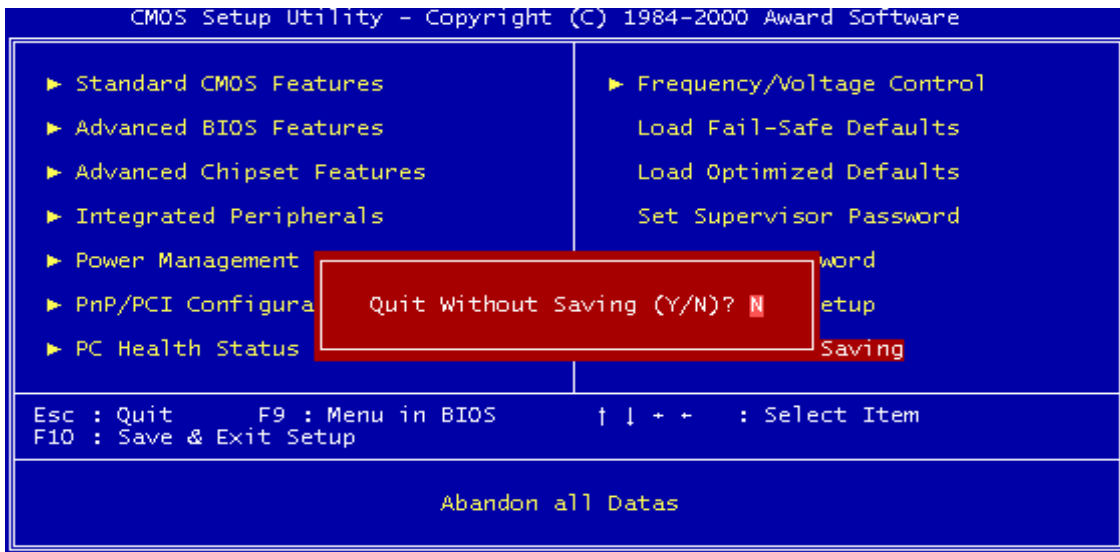

CHAPTER 4 BIOS UPGRADE

4.1 How to Check Your BIOS File Name and Version

Turn on your PC. The first screen will display as follows:

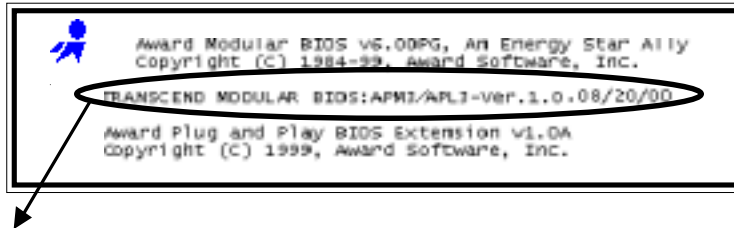

TRANSCEND MODULAR BIOS : APM3/APL3-Ver.1.01

The BIOS description occurs on the third line.

APM3/APL3 - Ver 1.01

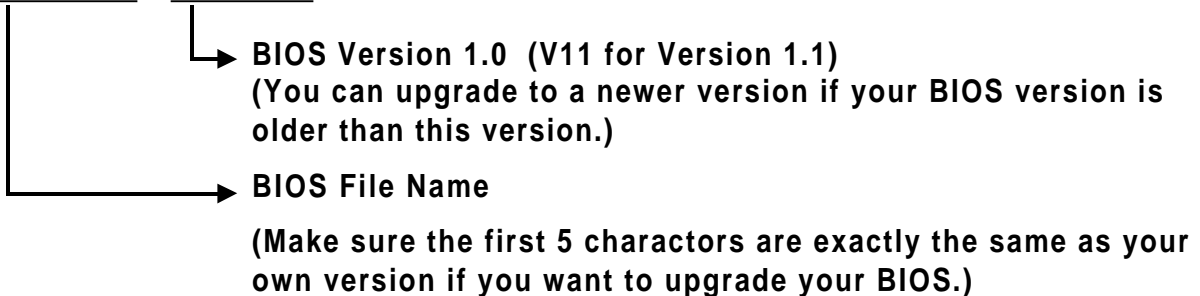

4.2 Download Correct BIOS File from Our Web Site

Go to the Transcend web site : <http://www.transcendusa.com/>

Choose "Motherboard".

Choose "BIOS".

Select the appropriate Transcend motherboard model.

The BIOS file name consists of 5 characters. Check the exact BIOS to download. Your BIOS file name must exactly match the one shown on our web site. Download the suitable version to your disk or other storage device.

Warning: Your system could be damaged, if a wrong BIOS version is accidentally used. If you are not sure what version you should choose, please contact us at techsupport@transcend.com.tw

4.3 How to Upgrade Your Motherboard BIOS

Please follow these 5 steps listed below to update your BIOS.

Step 1: Make a record of your original or existing BIOS Setup parameters.

- Press [Del] during the Power On Self Test to enter the BIOS Setup Program when you start your system.

- Write down the value of each parameter in order to re-configure your system after BIOS updating.

Step 2: Make a System Disk

- Insert an empty 3.5" disk in Drive A

 - MS-DOS: Key in **FORMAT A:/s** and press [Enter].

 - Windows O/S: Select the icon of [My Computer]

 - Click [3.5" Floppy (A:)]

 - Select [File/Format] from Command Bar

 - Under **Format 3.5** Floppy (A:) **Menu** Select

 - Format type = Full item and

 - Other Options = Copy system files

 - Click [Start] button

Step 3: Download the updated BIOS EXE file from the website to a second disk or other storage device.

(Ref 4.1 and 4.2)

Step 4: Execute the downloaded file to decompress it into several files.

Step 5: Please read the Readme.TXT file carefully, and follow the instructions step-by-step. Proceed with the BIOS update.