

TS-ABX31
Intel Socket 370 Celeron Series
USER'S MANUAL

Transcend

*Your Supplier, Your Partner,
Your Friend.*

User's Notice

This User's Manual is designed to assist system manufacturers or end users to set up and install the motherboard. All information within this document has been carefully checked. However, Transcend Information, Inc. (hereinafter referred to as "Transcend") carries no responsibility or liability to any error or inaccuracy which might occur in this manual, including the products and software mentioned in it. In addition, the information and specifications are subject to change without notice in advance.

Transcend Information, Inc. provides this manual "as is" without warranty of any kind, either expressed or implied, including but not limited to the implied warranties, conditions of merchantability or fitness for a particular purpose. In no event shall Transcend Information, Inc., its employers, employees, distributors, or agents be liable for any indirect, special, incidental, or consequential damages, including loss of profits, loss of business, loss of use or data, interruption of business and the like, even if Transcend Information, Inc. has been advised of the possibility of such damages arising from any defect or error in this manual or product.

All brands, product names, and trademarks mentioned in this document are the property of their respective owners or companies and are used only for identification or explanation.

Product Model: TS-ABX31

Manual Version: 1.1

Release Date: November, 1999

Table of Contents

CHAPTER 1 INTRODUCTION	1
1.1 Package Contents	1
1.2 Specifications and Features	1
CHAPTER 2 HARDWARE INSTALLATION	3
2.1 Transcend TS-ABX31 Motherboard	3
2.2 Layout of Transcend TS-ABX31 Motherboard.....	4
2.3 CPU Installation	5
2.4 66/100MHz System Configuration.....	6
2.5 CPU Internal Frequency Ratio Setting.....	6
2.6 Memory Configuration	8
2.7 Keyboard Wake Up	9
2.8 Primary / Secondary IDE Connectors	9
2.9 Floppy Disk Drive Connector	10
2.10 Fan Power Connectors	10
2.11 Wake-on-LAN Connector	11
2.12 IrDA-Compliant Infrared Module Connector	11
2.13 Panel Connectors.....	12
2.14 Power Connector.....	13
2.15 External Connectors.....	14
2.16 Clear CMOS Jumper.....	15

CHAPTER 3 BIOS SETUP 16

3.1 BIOS Setup 16

3.2 The Main Menu 16

3.3 Standard CMOS Setup 18

3.4 BIOS Features Setup 21

3.5 Chipset Features Setup 24

3.6 Power Management Setup 27

3.7 PnP/PCI Configuration Setup..... 30

3.8 Integrated Peripherals 32

3.9 Supervisor Password 35

3.10 User Password 36

3.11 IDE HDD Auto Detection 36

3.12 Save & Exit Setup 37

3.13 Exit Without Saving 37

3.14 Load BIOS Defaults 38

3.15 Load Setup Defaults 38

CHAPTER 4 BIOS UPGRADE 39

4.1 How to Check Your BIOS File Name and Version 39

4.2 Download Correct BIOS File from Web..... 39

4.3 How to Update Your Motherboard BIOS 39



CHAPTER 1 INTRODUCTION

1.1 Package Contents

This motherboard package contains the following items. If you discover any damaged or missing items, please contact your retailer.

- 1 - TS-ABX31 motherboard
- 2 - CD-ROM
- 3 - One FDD cable, one IDE cable
- 4 - User's Manual

1.2 Specifications and Features

● **CPU**

- Support Intel Socket 370 Celeron Series

● **Chipset**

- Intel 440BX AGP

● **DRAM Memory**

- Support Synchronous DRAM
- 3pcs of 168-pin DIMM module sockets on board
- 8~768 MB memory size
- 8/16/32/64/128/256MB SDRAM DIMM
- 64 data bits and ECC structure.

● **I/O BUS Slot**

- 1 AGP slot
- 4 Master / Slave PCI-BUS slots (PCI 2.1 compliant)
- 2 ISA BUS slots (one PCI/ISA shared)

● **I/O Functions**

- Support PIO Mode 3,4 ATAPI devices and Ultra DMA/33
 - Support 2 high speed UART 16550 COM Ports
 - Support EPP/ECP LPT Port
 - Support 1.44/2.88 MB floppy drive
-

- Support PS/2 mouse and PS/2 keyboard
- Support IrDA port
- Support 2 Universal Serial Bus Ports

- **Award BIOS**

- Support Plug-and-Play
- Support ACPI, DMI, Green Feature

- **Wake Up Features**

- PS/2 mouse and keyboard Wake Up
- Support Wake-on-LAN function
- Remote Ring Wake Up

- **PCB Dimensions**

- ATX form factor, 4-layer PCB, 17.3cm x 30.5cm (6.8inch x 12inch)
-

CHAPTER 2 HARDWARE INSTALLATION

2.1 Transcend TS-ABX31 Motherboard

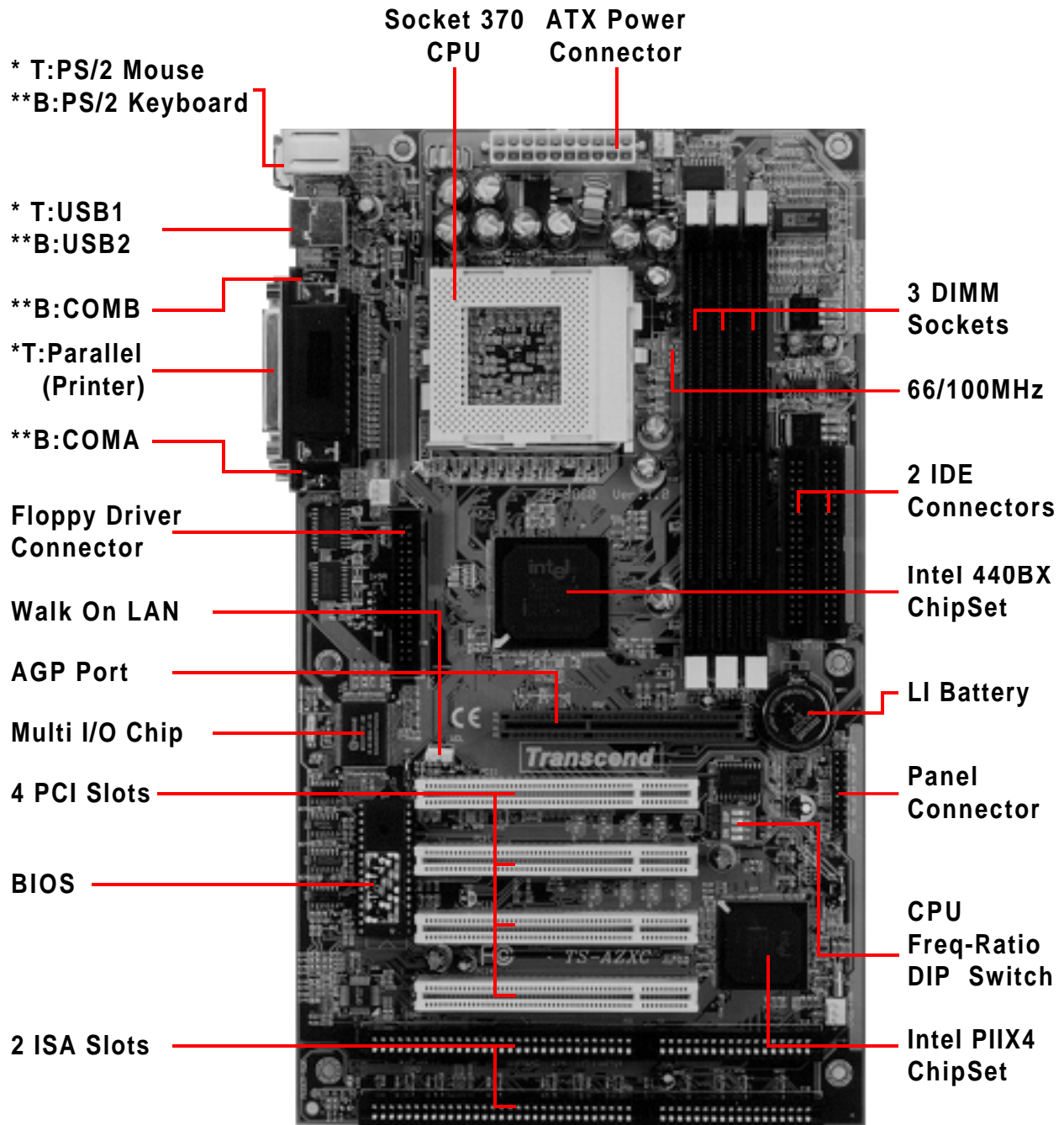

*T:Top

**B:Bottom

2.2 Layout of Transcend TS-ABX31 Motherboard

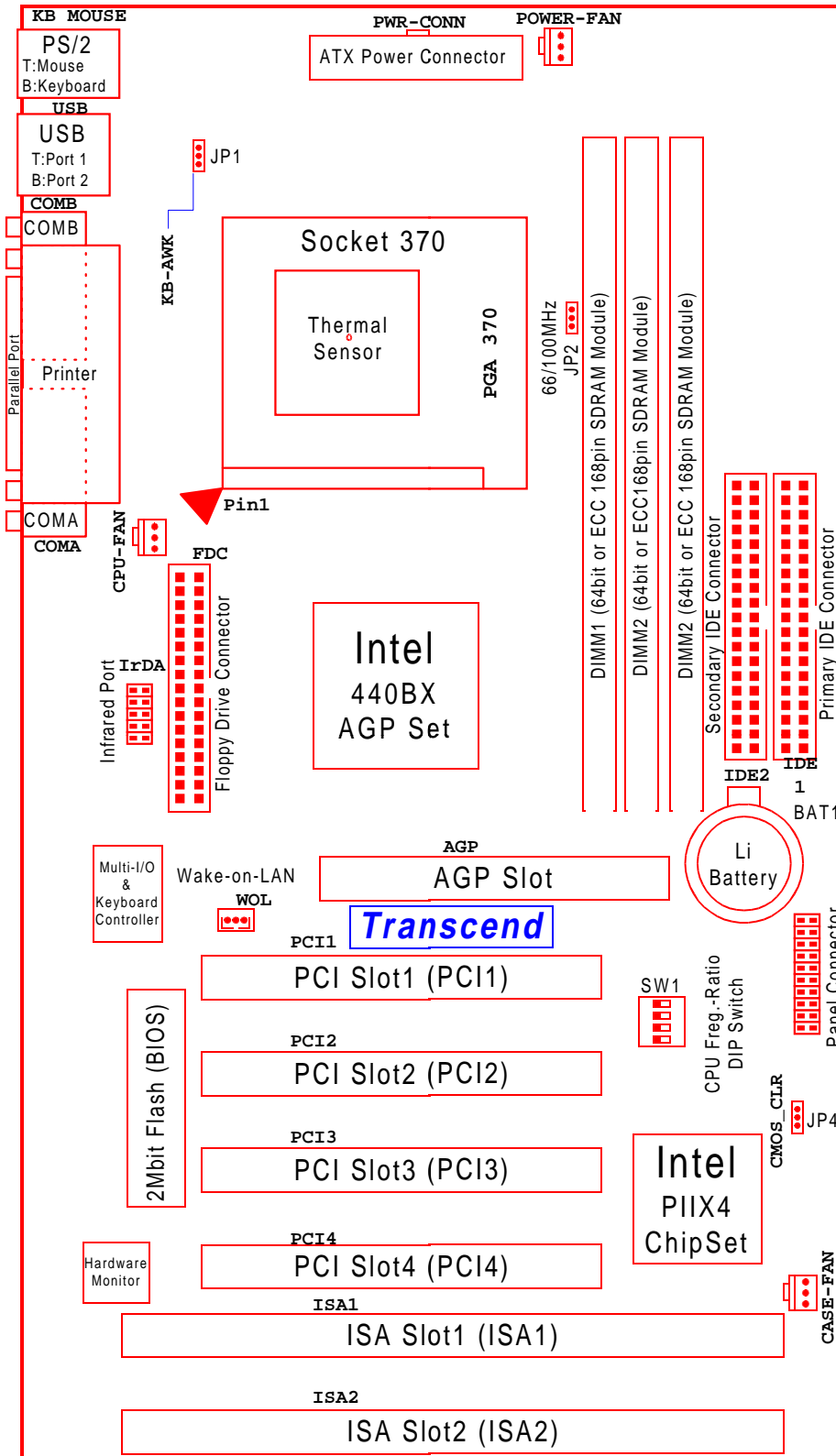

2.3 CPU Installation

The motherboard provides a ZIF Socket 370. The CPU that you bought must have a fan attached to it to prevent overheating. If there is no fan on it, please purchase a fan before you turn on your system.

WARNING! Be sure that sufficient air circulation is available across the processor's passive heatsink. Without sufficient circulation, the processor could overheat and damage both the processor and the motherboard. You may install an auxiliary fan, if necessary.

To install a CPU, first turn off your system and remove its cover. Locate the ZIF socket and open it by first pulling the lever sideways away from the socket then upwards to a 90-degree right angle. Insert the CPU with the correct orientation as shown below. The picture below is for reference only. You should have a CPU fan to cover the face of the CPU. With the added weight of the CPU fan, no force is required to insert the CPU. Once completely inserted, close the socket's lever while holding down the CPU.

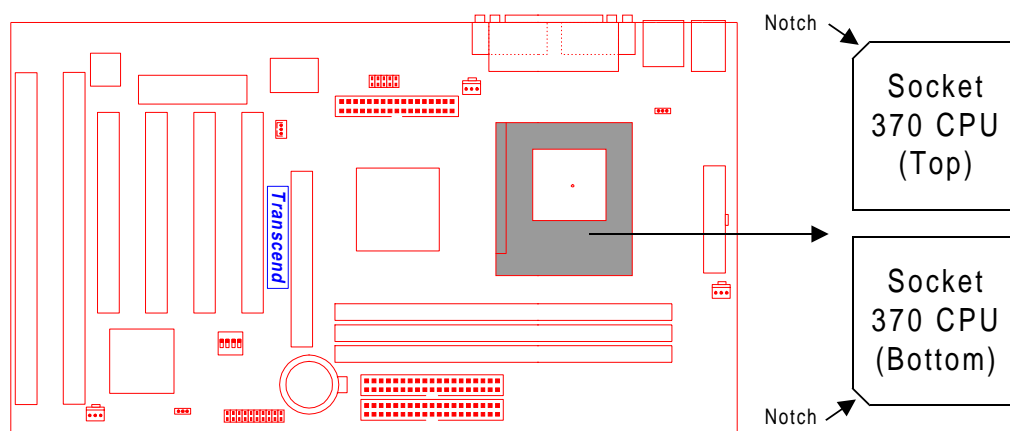

TS-ABX31 Socket 370

2.4 66/100MHz System Configuration

The jumper 2 (JP2) allows you to set FSB (Front Side Bus) to be 66 or 100MHz configuration. When you set FSB to 66MHz, you can select the system bus frequency from 66MHz to 83.3MHz through “CPU Host Clock (CPU/PCI)” of “Chipset Features Setup” in BIOS (Please refer to page 26). When you set FSB to 100MHz, you can select the system bus frequency from 100MHz to 150MHz through “CPU Host Clock (CPU/PCI)” of “Chipset Features Setup” in BIOS (Please refer to page 26).

NOTE: Because Celeron socket 370 CPU now can support 66MHz FSB only, we strongly recommend that you set JP2 as 66MHz. Otherwise it may cause system damaged. If Intel releases new version Celeron CPU to support 100MHz FSB, then you can set JP2 as 100MHz to increase system performance.

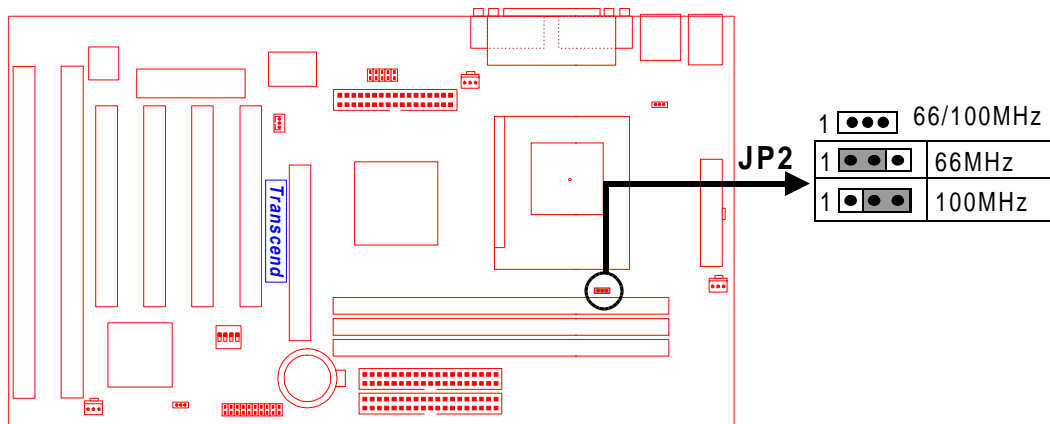

TS-ABX31 66/100MHz FSB Configuration Jumper

2.5 CPU Internal Frequency Ratio Setting

The switch 1 (SW1) is designated for adjusting the CPU internal frequency ratio. The frequency ratio is defined as the table shown below. The internal frequency can be calculated by the following formula:

$$\text{CPU internal frequency} = \text{frequency ratio} \times \text{system bus frequency} *$$

* System bus frequency is set in “CPU Host Clock (CPU/PCI)” of “Chipset Features Setup” in BIOS (Please refer to page 26).

NOTE: Because Intel has locked the Socket 370 Celeron CPU’s frequency ratio, setting SW1 to adjust the frequency ratio is useless. However, it may be effective if Intel unlocks the frequency ratio in the future.

CPU Internal Frequency	JP2	Freq.-Ratio	SW1			
			1	2	3	4
333/500MHz	66/100MHz	x 5.0	ON	OFF	OFF	ON
366/550MHz	66/100MHz	x 5.5	ON	OFF	OFF	OFF
400/600MHz	66/100MHz	x 6.0	OFF	ON	ON	ON
433/650MHz	66/100MHz	x 6.5	OFF	ON	ON	OFF
466/700MHz	66/100MHz	x 7.0	OFF	ON	OFF	ON
500/750MHz	66/100MHz	x 7.5	OFF	ON	OFF	OFF

O: ON 

X: OFF 

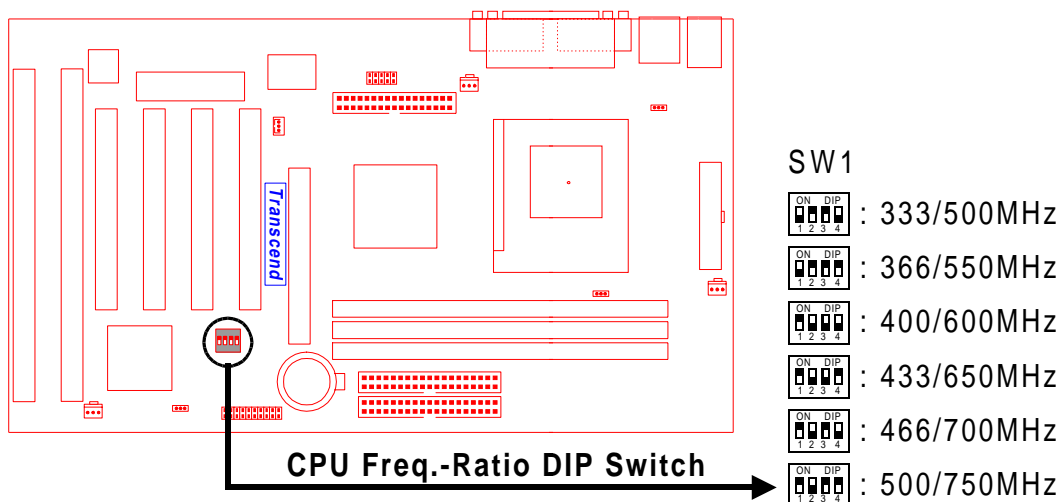

TS-ABX31 CPU Freq.-Ratio DIP Switch Setting

2.6 Memory Configuration

This motherboard must be installed with DIMM (Dual Inline Memory Module). The DIMMs must be 3.3 Volt synchronous DRAM modules. It also supports ECC (Error Checking and Correcting).

IMPORTANT: Memory speed setup is required through “Auto Configuration“ in BIOS Chipset Features Setup.

Install memory in any combination as follows:

DIMM Location	168-pin DIMM
DIMM1	SDRAM 8,16, 32, 64,128 ,256MBytes
DIMM2	SDRAM 8,16, 32, 64,128, 256MBytes
DIMM3	SDRAM 8,16, 32, 64,128, 256MBytes
Total Memory	768MBytes (MAX.)

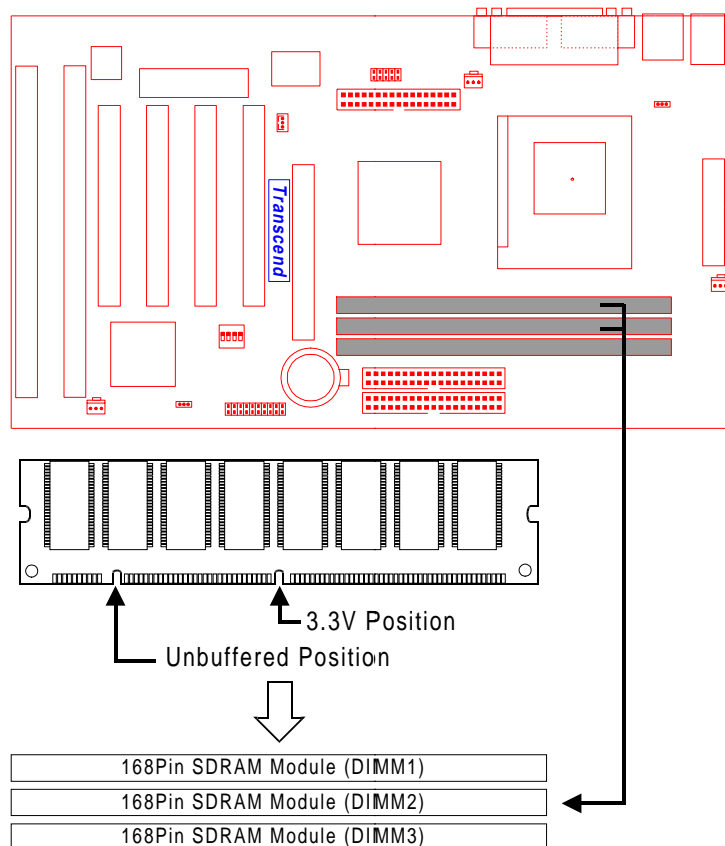

TS-ABX31 168Pin DIMM Sockets

2.7 Keyboard Wake Up (3-pin KB-AWK)

This function disables or enables you to use the keyboard to power up the system. Set this jumper to “Enable” if you wish to use your keyboard to power up your computer.

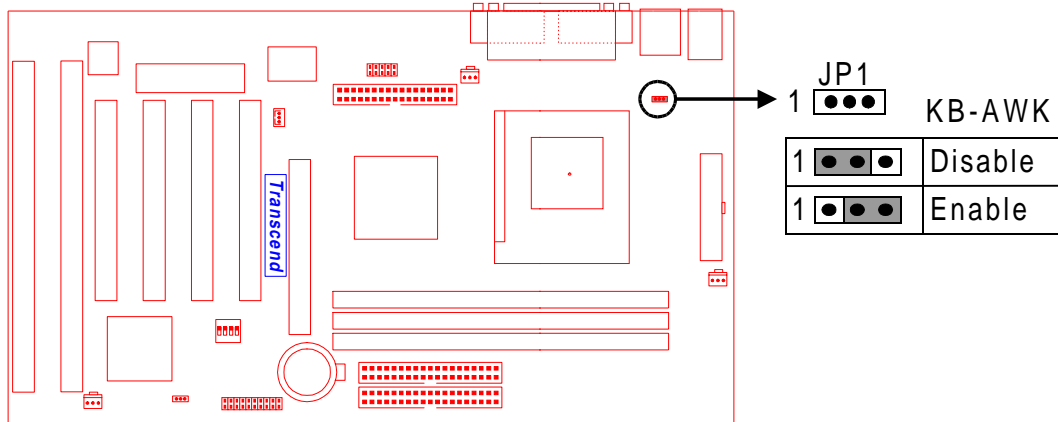

TS-ABX31 Keyboard Wake Up

2.8 Primary / Secondary IDE Connectors (Two 40-pin IDE)

This motherboard supports two 40-pin IDE connectors marked as IDE1 (primary channel) and IDE2 (secondary channel). Each channel supports two IDE devices that make total of four devices. In order to work together, two devices on each channel must be set differently to master and slave mode, either one can be hard disk or CDROM. The setting as master or slave mode depends on the jumper on your IDE devices. Please refer to their manual accordingly. Connect your first IDE hard disk to master mode of the primary channel.

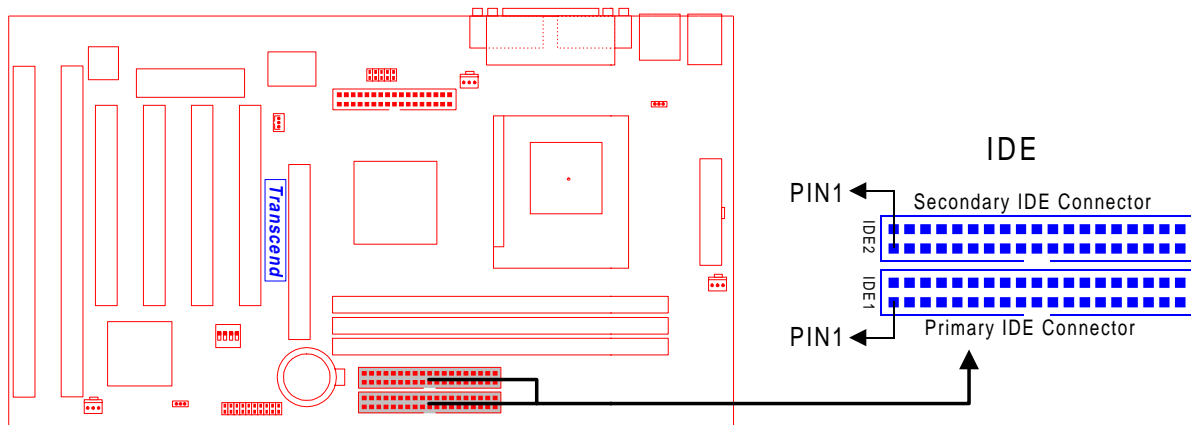

TS-ABX31 IDE Connectors

2.9 Floppy Disk Drive Connector (34-pin FDC)

This connector supports the provided floppy disk drive ribbon cable. After connecting the single end to the board, connect the two plugs on the other end to the floppy drives.

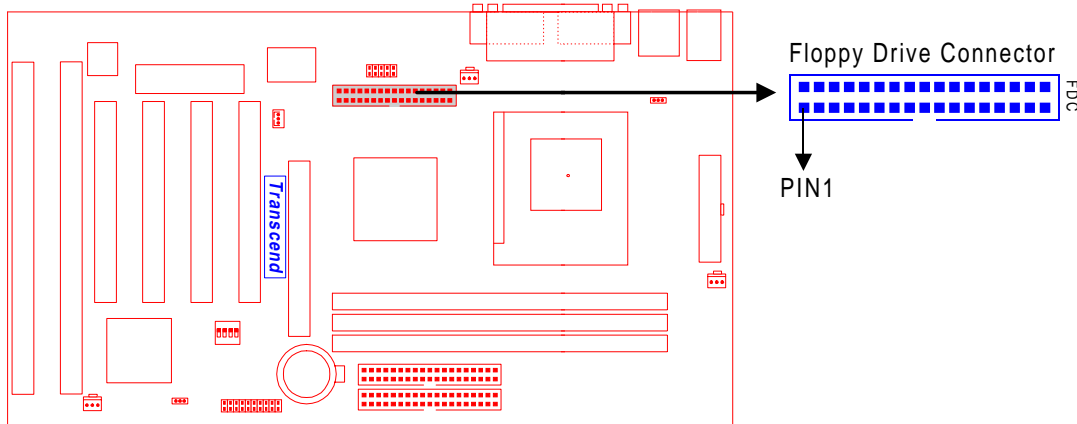

TS-ABX31 Floppy Disk Drive Connector

2.10 Fan Power Connectors

There are three fan power connectors on the motherboard: CPU_FAN, POWER_FAN, and CASE_FAN. Each connector provides +12V power. Make sure it is in the right orientation, or it may cause damages. These connectors support cooling fans of 500 mA (6W) or less.

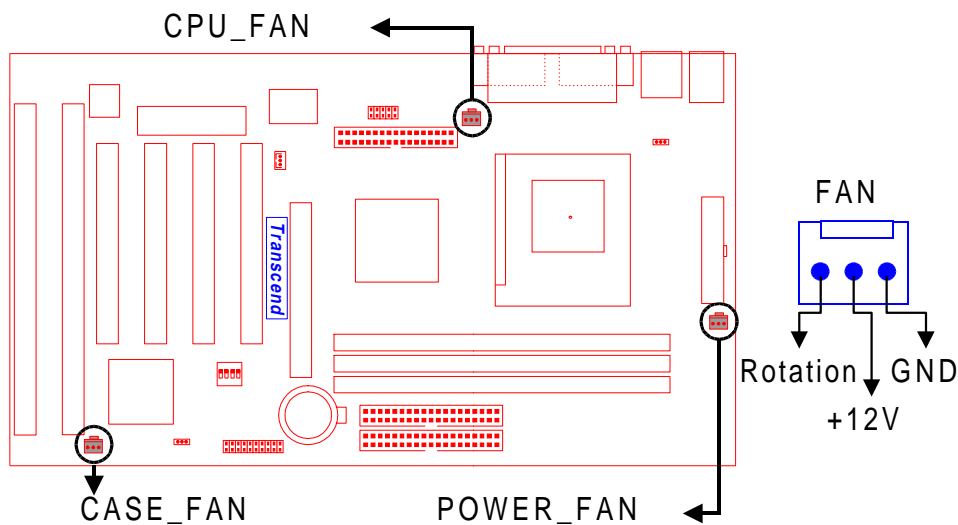

TS-ABX31 Fan Power Connectors

2.11 Wake-on-LAN Connector (3-pin WOL)

This connector connects to LAN cards with a Wake-on-LAN output. The system can be powered up when a wakeup packet or signal is received from the LAN card.

NOTE: This function requires that the Wake-on-LAN Power Up Control is set to “Enabled” and that your system has an ATX power supply with at least 720mA +5V standby power.

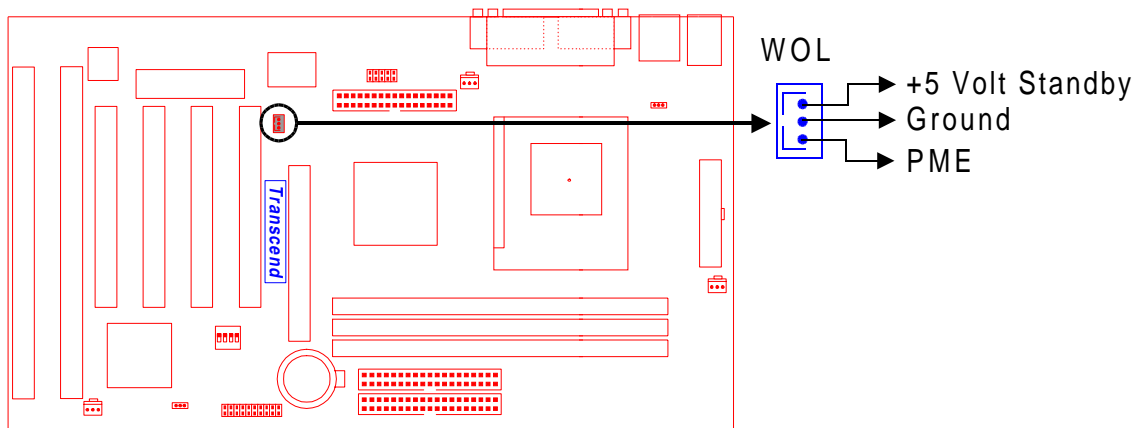

TS-ABX31 Wake-on-LAN Connector

2.12 IrDA-Compliant Infrared Module Connector (5-pin IrDA)

The IrDA connector can be configured to support wireless infrared module. With this module and application software such as Laplink or Win95 Direct Cable Connection, user can transfer files to or from laptops, notebooks, PDA and printers.

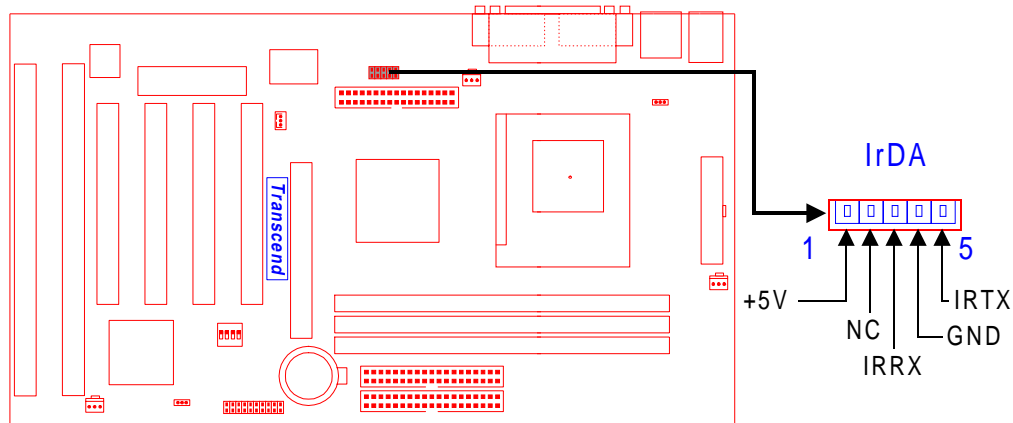

TS-ABX31 IrDA Connector

2.13 Panel Connectors

Power LED Lead (3-pin KEYLOCK)

This 3-pin connector attaches to the power LED.

Pin1 : +5V
Pin2 : NC
Pin3 : GND

Keylock Lead (2-pin KEYLOCK)

Use the keylock to enable or disable the keyboard.

Pin4 : KEYLOCK
Pin5 : GND

Speaker Lead (4-pin SPEAKER)

This 4-pin connector connects to the case-mounted speaker.

Pin7 : +5V
Pin8 : GND
Pin9 : NC
Pin10 : SPK

Suspend Mode LED Lead (2-pin S_LED)

The S_LED will light when the suspend mode works.

Pin11 : +5V
Pin12 : GND

Harddisk LED Lead (2-pin HDD_LED)

This 2-pin connector connects to LED of harddisk. The LED lights when a HDD is active.

Pin13 : +5V
Pin14 : GND

Suspend Switch Lead (2-pin SUS)

This allows the user to manually place the system into the suspend mode or “Green” mode where system activities will be instantly decreased to save electricity and expand the life of certain components when the system is not in use.

Pin15 & Pin16

Reset Switch Lead (2-pin RESET)

This 2-pin connector connects to the case-mounted reset switch for rebooting your computer without having to turn off your power switch.

Pin17 & Pin18

Software Power-Off Lead (2-pin SOFT_OFF)

Attach the SOFT_OFF Switch of the panel to this connector.

Pin19 & Pin20

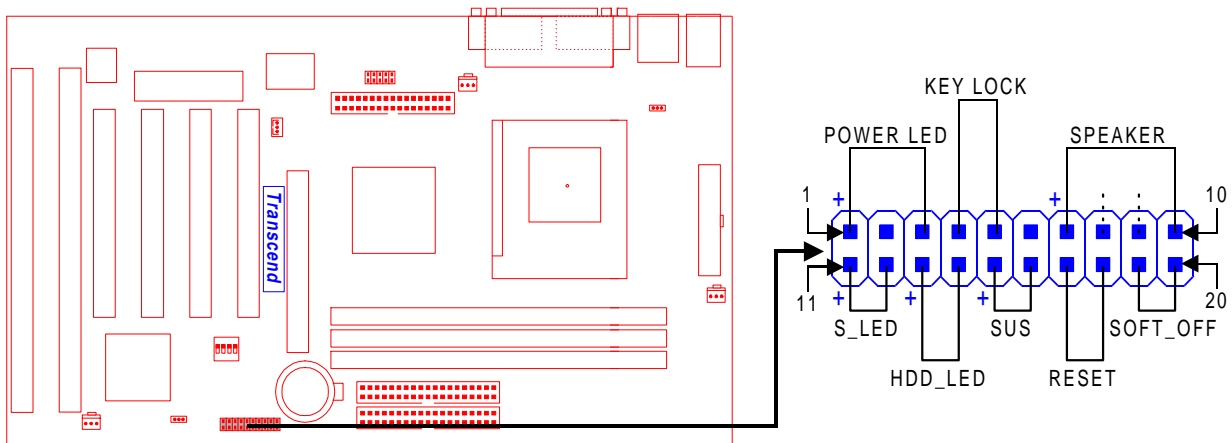

TS-ABX31 Panel Connector

2.14 Power Connector (20-pin PWR_CONN)

Make sure to plug the ATX power supply connector to the right direction. The pin definition is shown below. Make sure that your ATX power supply can support at least 10mA on the standby lead.

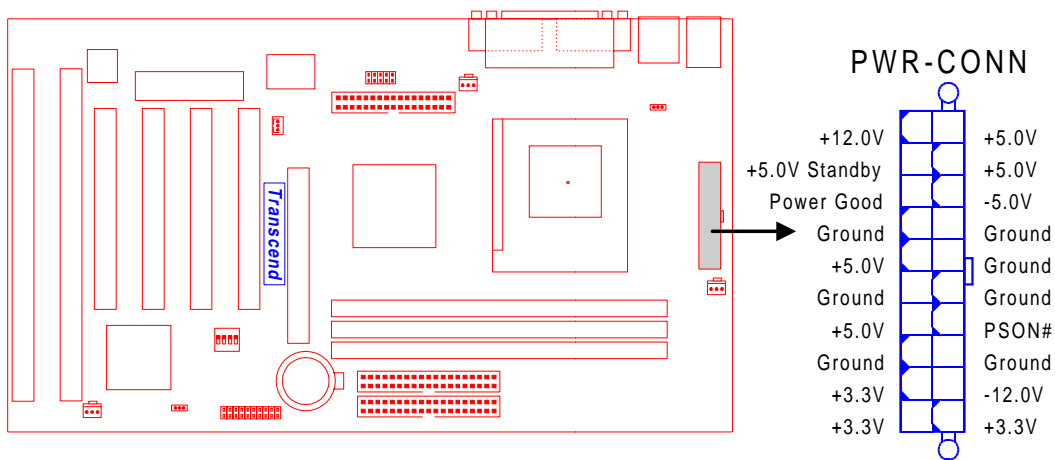

TS-ABX31 Power Connector

PSON# : Power Supply on

2.15 External Connectors

There are 5 kinds of external connectors on the motherboard.

1. PS/2 Mouse Connector (6-pin MOUSE)

The onboard PS/2 mouse connector is a 6-pin Mini-Din connector marked “MOUSE”

The view angle of drawing shown here is from back panel of the housing.

2. PS/2 Keyboard Connector (6-pin KB)

The onboard PS/2 keyboard connector is a 6-pin Mini-Din connector marked “KB”. The view angle of drawing shown here is from back panel of the housing.

3. Universal Serial BUS USB Ports 1 & 2 (Two 4-pin USBs)

You can attach USB devices to the USB connector. The motherboard contains two USB connectors, which are marked as “USB”.

4. Parallel Port Connector (25-pin PRN)

The onboard printer connector is a 25-pin D-type connector marked “PRN”. The view angle of drawing shown here is from back panel of the housing.

5. Serial Port Connectors (Two 9-pin COMA/COMB)

The onboard serial connectors are 9-pin D-type connectors on the back panel of motherboard. The serial port1 connector is marked as”COMA” and the serial port2 connector is marked as ”COMB”.

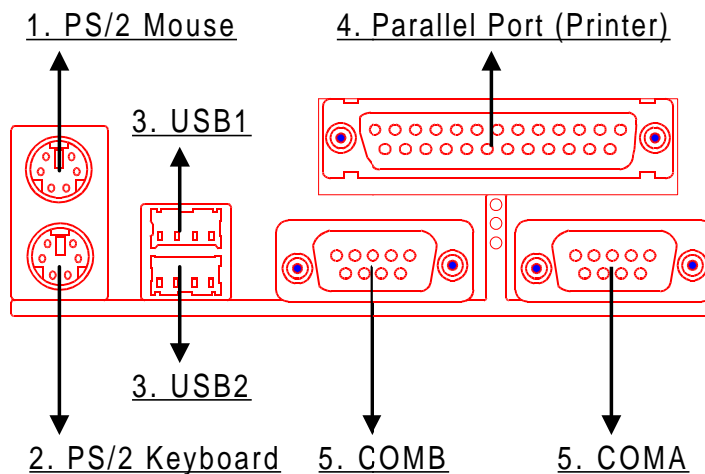

TS-ABX31 External Connectors

2.16 Clear CMOS Jumper (3-pin JP4)

To clear the CMOS data, you should turn off your computer power and short the pin1 and pin2 of JP4.

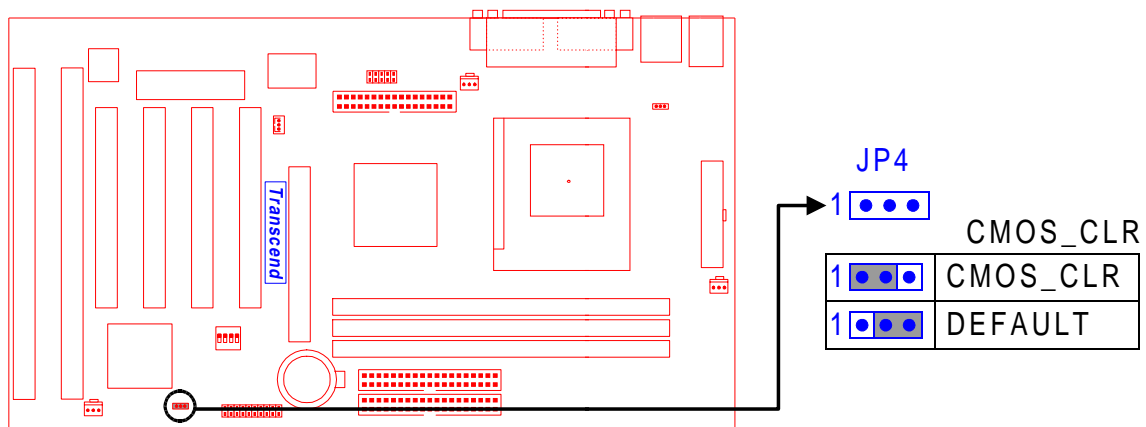

TS-ABX31 Clear CMOS Jumper

CHAPTER 3 BIOS SETUP

3.1 BIOS Setup

Award BIOS has a built-in Setup program that allows users to modify the basic system configuration. This information is stored in CMOS RAM. So it can retain the Setup information when the power is turned off. When the battery of CMOS fails, it will cause the data lost. When it happens, you should set up your configuration parameters again after replacing the battery.

3.2 The Main Menu

As you turn on or reboot the system, the BIOS is immediately activated. It will read the system configuration information, and check the system through Power On Self Test (POST). During the POST process, press the [Del] key, and you can enter the Award BIOS configuration system. The following screen will appear.

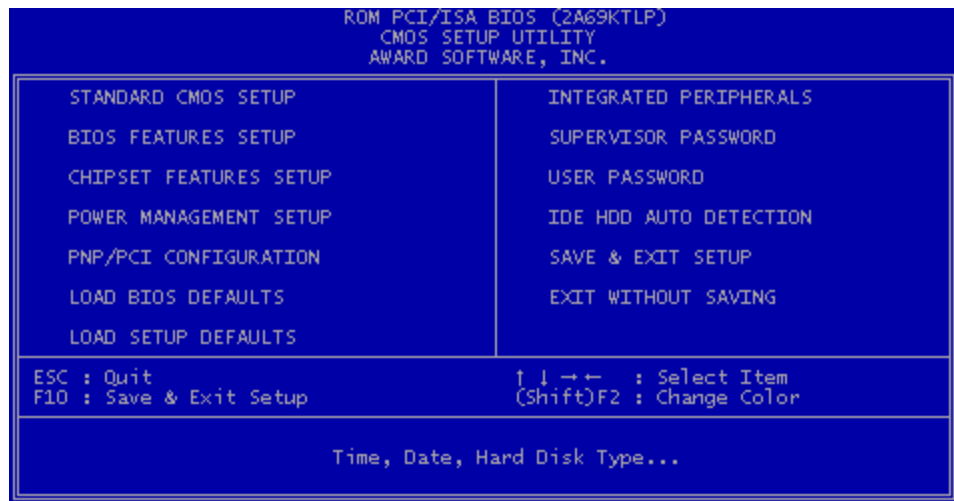

In the Award BIOS system, you can use the arrows (↑ ↓ → ←) to highlight the item, and press the [Enter] key to enter the sub-menu. The following keys help you navigate in Setup.

- Esc Main Menu: Quit and not save changes into CMOS RAM
- Other pages: Exit current page and return to Main Menu
- PgUp Increase the numeric value or make changes
- PgDn Decrease the numeric value or make changes
- + Increase the numeric value or make changes
- Decrease the numeric value or make changes

F1	General help, only for Status Page Setup Menu and Option Page Setup Menu
F2	Change color from total 16 colors F2 to select color forward Shift + F2 to select color backward
F3	Calendar, only for Status Page Setup Menu
F5	Restore the previous CMOS value from CMOS, only for Option Page Setup Menu
F6	Load the default CMOS RAM value from BIOS default table, only for Option Page Setup Menu
F7	Load the default
F10	Save all the CMOS changes, only for Main Menu

The Following is a brief summary of each setup category.

- **STANDARD CMOS SETUP**

Options in the original PC AT-compatible BIOS

- **BIOS FEATURES SETUP**

Award enhanced BIOS options

- **CHIPSET SETUP**

Available options specific to your system Chipset

- **POWER MANAGEMENT SETUP**

Advanced Power Management (APM) options

- **PnP/PCI CONFIGURATION**

Plug and Play standard and PCI Local Bus configuration options

- **LOAD BIOS DEFAULTS**

BIOS defaults are factory settings for the most stable, minimal-performance system operations.

- **LOAD SETUP DEFAULTS**

Setup defaults are factory settings for optimal-performance system operations.

- **INTEGRATED PERIPHERALS**

I/O subsystems that depend on the integrated peripherals controller in your system

- **SUPERVISOR / USER PASSWORD**

Change, set, or disable a password. In some BIOS versions that allow separate user and supervisor passwords, only the supervisor password permits access to Setup. The user password generally allows only power-on access.

- **IDE HDD AUTO DETECTION**

Automatically detect and configure IDE hard disk parameters.

- **SAVE & EXIT SETUP**

Save settings in nonvolatile CMOS RAM and exit Setup.

- **EXIT WITHOUT SAVING**

Abandon all changes and exit Setup.

3.3 Standard CMOS Setup

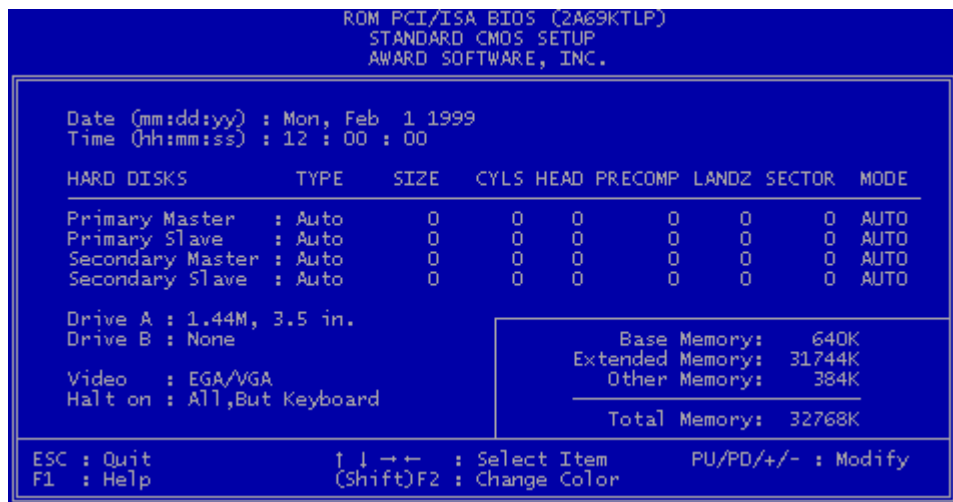

- **Date (mm:dd:yy) / Time (hh:mm:ss)**

Highlight the items and use PageUp/PageDown to change the value of Date/Time.

- **Primary Master / Primary Slave / Secondary Master / Secondary Slave**

This mainboard can support four IDE devices. We recommend that you select type “AUTO” for all drives. The BIOS can automatically detect the specifications and optimal operating mode of almost all IDE hard drives. When you select type “AUTO” for a hard drive, the BIOS detects its specifications during POST while the system boots. If you do not want to select drive type “AUTO”, other methods of selecting the drive type are also available.

1. Match the specifications of your installed IDE hard drive(s) with the preprogrammed values for drive type 1 through 45.
2. Select "USER" and enter values into each drive parameter field.
3. Use the "IDE HDD AUTO DETECTION" function in Main Menu.

Here are the brief explanations of drive specifications.

- * TYPE : The BIOS contains a table of pre-defined drive types. Each defined drive type has a specified number of cylinders, number of heads, write precompensation factor, landing zone, and number of sectors. Drives whose specifications do not accommodate any pre-defined type are classified as type "USER".
 - * SIZE : Disk drive capacity (approximately). Note that this size is usually slightly greater than the size of a formatted disk given by a disk-checking program.
 - * CYLS : Number of cylinders
 - * HEAD : Number of heads
 - * PRECOMP : Write precompensation cylinder
 - * LANDZ : Landing zone
 - * SECTOR : Number of sectors
 - * MODE : AUTO, NORMAL, LARGE, or LBA
 - AUTO : The BIOS automatically determines the optimal mode.
 - NORMAL : Maximum number of cylinders, heads, and sectors supported are 1024, 16, and 63 respectively.
 - LARGE : For drives that do not support LBA and have more than 1024 cylinders.
 - LBA (Logical Block Addressing) : During drive access, the IDE controller transforms the data address described by sector, head, and cylinder number into a physical block address. This will significantly improve data transfer rates for drives with greater than 1024 cylinders.
-

• Drive A / Drive B

Select the correct specifications for the diskette drive(s) installed in the computer.

- None : No diskette drive installed
- 360K, 5.25 in : 5-1/4 inch PC-type standard drive; 360 kilobyte capacity
- 1.2M, 5.25 in : 5-1/4 inch AT-type high-density drive; 1.2 megabyte capacity
- 720K, 3.5 in : 3-1/2 inch double-sided drive; 720 kilobyte capacity
- 1.44M, 3.5 in : 3-1/2 inch double-sided drive; 1.44 megabyte capacity
- 2.88M, 3.5 in : 3-1/2 inch double-sided drive; 2.88 megabyte capacity

• Video

Select the type of primary video subsystem in your computer. The BIOS usually detects the correct video type automatically. The BIOS supports a secondary video subsystem, but do not select it in this Setup.

- EGA/VGA : Enhanced Graphics Adapter/Video Graphics Array. For EGA, VGA, SEGA, SVGA or PGA monitor adapters.
- CGA 40 : Color Graphics Adapter, powers up in 40-column mode
- CGA 80 : Color Graphics Adapter, powers up in 80-column mode
- MONO : Monochrome adapter, includes high resolution monochrome adapters

• Halt On

During the Power On Self Test (POST), the computer stops if the BIOS detects a hardware error. You can set the BIOS to ignore certain errors during POST and continue the boot-up process. The followings are the selections.

- No Errors : POST does not stop for any error.
 - All Errors : If the BIOS detects any non-fatal error, POST stops and prompts you to take corrective action.
 - All, But Keyboard : If the BIOS detects any non-fatal error except keyboard, POST stops and prompts you to take corrective action.
 - All, But Diskette : If the BIOS detects any non-fatal error except floppy disk drive, POST stops and prompts you to take corrective action.
 - All, But Disk / Key : If the BIOS detects any non-fatal error except floppy disk drive or keyboard, POST stops and prompts you to take corrective action.
-

3.4 BIOS Features Setup

This “BIOS FEATURES SETUP” option allows you to improve your system performance and set up system features according to your preference.

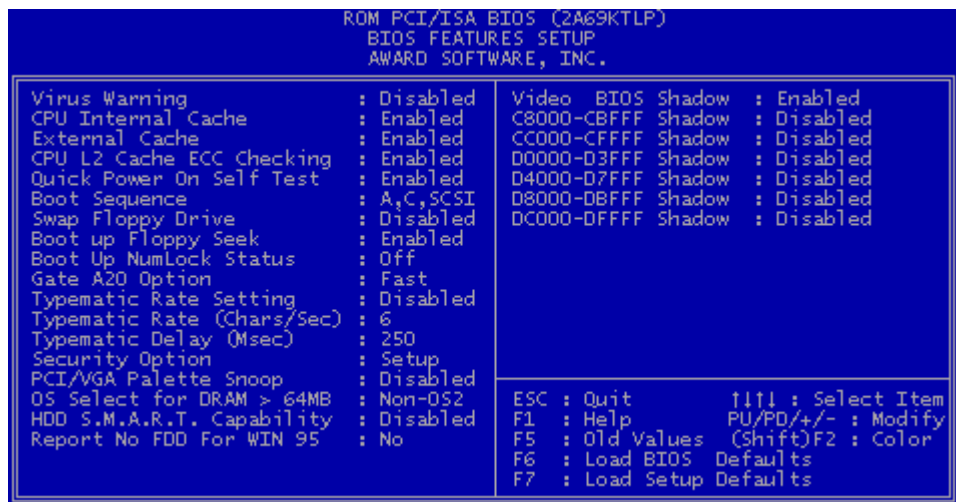

- **Virus Warning**

When the function is enabled, you will receive a warning message if a program (specifically, a virus) attempts to write to the boot sector or the partition table of the hard disk drive. You should then run an anti-virus program. Keep in mind that this feature protects the boot sector only, not the entire hard drive.

NOTE: Many disk diagnostic programs that access the boot sector table can trigger the virus warning message. If you plan to run such a program, we recommend that you first disable the virus warning.

- **CPU Internal Cache / External Cache**

Cache memory is additional memory that is much faster than conventional DRAM (system memory). CPUs from 486-type or up contain internal cache memory. Most, but not all, modern PCs have additional (external) cache memory. When the CPU requests data, the system transfers the requested data from the main DRAM into cache memory for even faster access by the CPU. The External Cache field may not appear if your system does not have external cache memory.

- **CPU L2 Cache ECC Checking**

Select “Enabled” to make sure the data accuracy.

- **Quick Power On Self Test**

Select “Enabled” to reduce the amount of time required to run the Power-On Self-Test (POST). A quick POST skips certain steps. We recommend that you normally disable quick POST. It's better to find a problem during POST than to lose data during your work.

- **Boot Sequence**

The original IBM PCs load the DOS operating system from drive A (floppy disk). So, IBM PC-compatible systems are designed to search for an operating system first on drive A, and then on drive C (hard disk). However, the BIOS now offers 11 different boot sequence options. In addition to the traditional drives A and C, options include IDE hard drives D, E, and F; plus a SCSI hard drive, a LS/ZIP drive and a CD-ROM drive.

- **Swap Floppy Drive**

This field is effective only in systems with two floppy drives. Selecting “Enabled” assigns physical drive B to logical drive A, and physical drive A to logical drive B.

- **Boot Up Floppy Seek**

While enabled, the BIOS will seek drive A once.

- **Boot Up NumLock Status**

Toggle between On and Off to control the state of the NumLock key when the system boots. When toggled On, the numeric keypad generates numbers instead of controlling cursor operations.

- **Gate A20 Option**

Choose “Fast” (default) or “Normal”. “Fast” allows RAM access above 1MB to use the fast gate A20 line.

- **Typematic Rate Setting**

When this function is disabled, the following two items (Typematic Rate and Typematic Delay) are irrelevant. Keystrokes repeat at a rate determined by the keyboard controller in your system. When this function is enabled, you can select a typematic rate and typematic delay.

- **Typematic Rate (Chars / Sec)**

When the typematic rate setting is enabled, you can select a typematic rate (the rate at which character repeats) when you hold down a key of 6, 8, 10, 12, 15, 20, 24 or 30 characters per second.

- **Typematic Delay (Msec)**

When the typematic delay setting is enabled, you can select a typematic delay (the delay before key strokes begin to repeat) of 250, 500, 750 or 1000 milliseconds.

- **Security Option**

If you have set a password, select whether the password is required while the system boots, or only when you enter "Setup".

- **PCI/VGA Palette Snoop**

This function is used to prevent conflict when a MPEG card or some capture cards use the same palette address. Enable this to make the cards work normally.

- **OS Select for DRAM > 64MB**

Select "OS2" only if you are running OS/2 operating system with greater than 64 MB of RAM on your system.

- **HDD S.M.A.R.T capability**

S.M.A.R.T. (Self-Monitoring Analysis and Reporting)

If your hard disk supports this function, select "Enabled".

- **REPORT NO FDD FOR WIN95**

Select "Yes" to report when there is no floppy disk drive under win95 operating system.

- **Video BIOS Shadow**

Software that resides in a read-only memory (ROM) chip on a device is called firmware. The Award BIOS permits shadowing of firmware such as the system BIOS, video BIOS, and similar operating instructions that come with some expansion peripherals, such as a SCSI adapter. Shadowing copies firmware from ROM into system RAM, where the CPU can read it through the 64-bit DRAM bus. Firmware not shadowed must be read by the system through the 8-bit or 16-bit X-bus. Shadowing improves the performance of the system BIOS and similar ROM firmware for expansion peripherals, but it also reduces the amount of high memory (640KB to 1MB) available for loading device drivers, etc. Enable shadowing into

each section of memory separately. Many system designers hardwire shadowing of the system BIOS and eliminate a System BIOS Shadow option. Video BIOS shadows into memory area C0000-C7FFF. The remaining areas shown on the “BIOS Features Setup” screen may be occupied by other expansion card firmware. If an expansion peripheral in your system contains ROM-based firmware, you need to know the address range the ROM occupies to shadow it into the correct area of RAM.

3.5 Chipset Features Setup

This option will change the values of the chipset registers and the system setting will alter. Do not change any values if you are not familiar with the chipset.

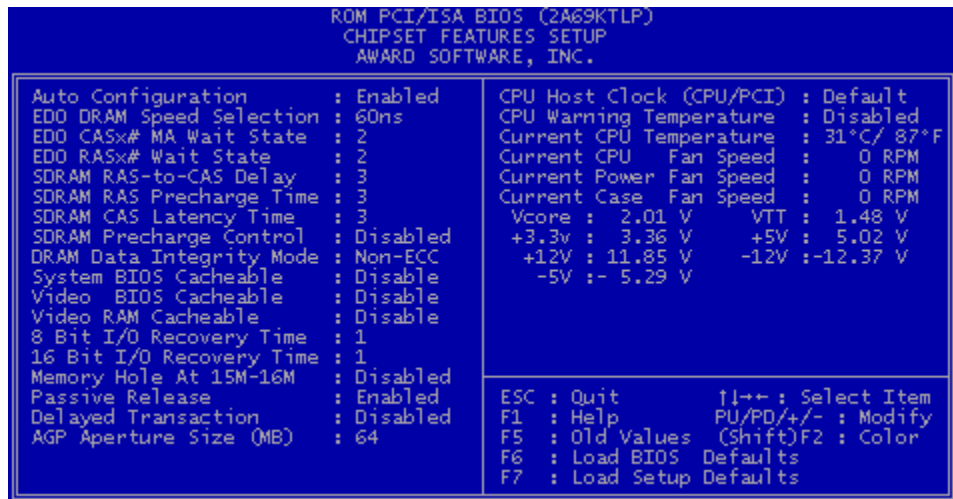

- **Auto Configuration**

Auto configuration selects predetermined optimal values of chipset parameters. When this function is disabled, chipset parameters revert to setup information stored in CMOS. Many fields in this screen are not available when Auto Configuration is enabled.

- **EDO DRAM Speed Selection**

The value in this field depends on performance parameters of the installed EDO memory chips (DRAM). Do not change the value from the factory setting unless you install new memory that has a different performance rating than the original DRAMs.

- **EDO CASx# MA Wait State / EDO RASx# MA Wait State**

Because the normal DRAM access speed is lower, CPU must wait for DRAM, this function could set up DRAM Memory Access wait state.

- **SDRAM RAS-to-CAS Delay**

This controls the latency between SDRAM active command and the read/write command. Leave on default setting.

- **SDRAM RAS Precharge Time**

This controls the idle clocks after issuing a precharge command to SDRAM. Leave on default setting.

- **SDRAM CAS Latency Time**

This controls the SDRAM performance, default is 3 clocks. If your SDRAM DIMM specification is 2 CAS latency, change 3 to 2 for better performance.

- **SDRAM Precharge Control**

This option is to determine the number of clocks required to deassert RAS and the timing for SDRAM to do precharge before next RAS can be issued.

- **DRAM Data Integrity Mode**

NON-ECC : Disable Error Correct Check function.

ECC : Enable Error Correct Check Function.

- **System BIOS Cacheable**

Selecting "Enabled" allows caching of the system BIOS. This action can increase system performance.

- **Video BIOS Cacheable**

Selecting "Enabled" allows caching of the video BIOS. This action can increase system performance.

- **Video RAM Cacheable**

Selecting "Enabled" allows caching of the video RAM, which results in better system performance. However, if any program writes to this memory area, a system error may occur.

- **8 Bit I/O Recovery Time**

Recovery time is needed for old 8-bit ISA cards. Default setting is 1 ISA clock. If you find any unstable 8-bit ISA card, you may try to extend the I/O recovery time.

- **16 Bit I/O Recovery Time**

Recovery time is needed for 16-bit ISA cards. Default setting is 1 ISA clock. If you find any unstable 16-bit ISA cards, you may try to extend the I/O recovery time.

- **Memory Hold At 15M-16M**

Enabling this feature reserves memory address space from 15MB to 16MB to ISA expansion cards that specifically require this setting. This makes the memory from 15MB and up unavailable to the system. Expansion cards can only access memory up to 16MB. The default is “Disabled”.

- **Passive Release**

ISA access speed is lower than PCI access speed. While power on, the ISA interface would release master bus control. The master bus control will go back ISA until other device accesses data.

- **Delayed Transaction**

PCI access speed is faster than ISA. So PCI would release master bus to ISA interface for accessing data. Then the master bus control would go back to PCI again.

- **AGP Aperture Size (MB)**

Select the size of the Accelerated Graphics Port (AGP) aperture. The aperture is a portion of the PCI memory address range dedicated to graphics memory address space. Host cycles that hit the aperture range are forwarded to the AGP without any translation. For more information, please refer to www.agpforum.org for AGP information.

- **CPU Host Clock (CPU/PCI)**

This function allows you to set FSB frequency of the CPU and the speed of PCI bus. When JP2 is set to 66MHz, then default FSB is 66MHz, and there are several options under 100MHz available. When JP2 is set to 100MHz, then default FSB is 100MHz, and there are also several options above 100MHz available for you to choose.

- **CPU Warning Temperature**

Enable this item to protect the CPU from overheating.

- **Current CPU FAN Speed**

This item will show the fan speed of CPU by RPM.

- **Current Power FAN Speed**

This item will show the fan speed of power by RPM.

- **Current CASE FAN Speed**

This item will show the fan speed of case by RPM.

3.6 Power Management Setup

The Power Management Setup allows you to configure your system to save energy most effectively while operating in a manner consistent with your own style of computer use.

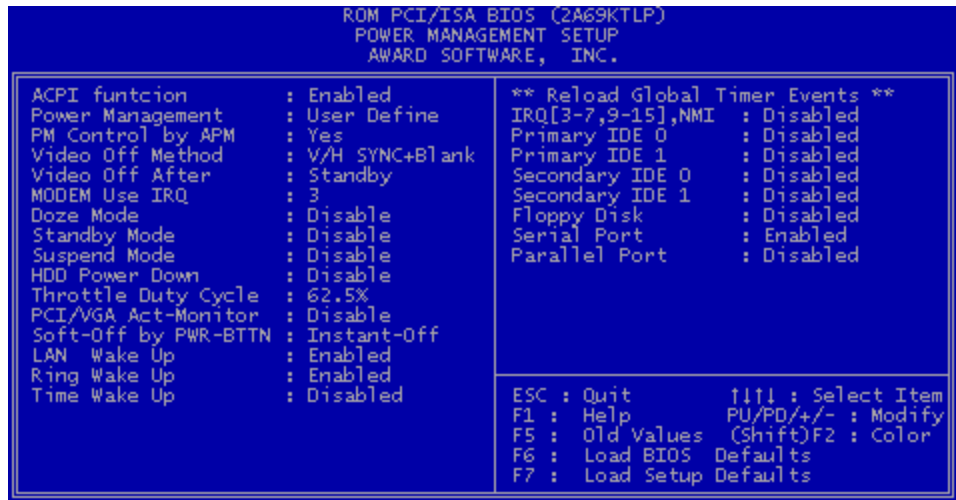

- **ACPI function**

This item allows you to enable/disable the Advanced Configuration and Power Management (ACPI).

The choice: Enabled, Disabled.

- **Power Management**

This category allows you to select the type (or degree) of power saving and is directly related to the following modes.

1. Doze Mode
2. Standby Mode
3. Suspend Mode
4. HDD Power Down

There are three selections for Power Management. Three of which have fixed mode settings.

1. Disable (Default) : No power management. Disable all four modes.
2. Min. Power Saving : Minimum power management mode. Inactivity period is defined as below.

Doze Mode = 1 hr.

Standby Mode = 1 hr.

Suspend Mode = 1 hr.

HDD Power Down = 15 min.

3. Max. Power Saving : Maximum power management mode. Inactivity period is defined as below.

Doze Mode = 1 min.

Standby Mode = 1 min.

Suspend Mode = 1 min.

HDD Power Down = 1 min.

4. User Defined : Allow you to set each mode individually. Select time-out period for each mode shown above.

• **PM Control by APM**

When enabled, an Advanced Power Management device will be activated to enhance the Max. Power Saving mode and stop the CPU internal clock.

If the Max. Power Saving is not enabled, this will be preset to “No”.

• **Video Off Method**

Determine the manner in which the monitor is blanked.

-V/H SYNC+BLANK : System turns off vertical and horizontal synchronization and ports and writes blanks to the video buffer.

-DPMS : Select this option if your monitor supports the Display Power Management Signaling (DPMS) standard of the Video Electronics Standards Association (VESA). Use the software supplied for your video subsystem to select video power management values.

- Blank Screen : System only writes blanks to the video buffer.

• **Video Off After**

Select the power-saving modes during which the monitor goes blank.

Doze : Monitor remains “on” during Doze modes.

Suspend : Monitor blanked when system enters Suspend mode.

N/A : It is default. When system enters power-saving mode, it does not do the video off action.

• **MODEM Use IRQ**

You can select one of the following interrupt resources for modem use: 3.4.5.7.9.10.11.

There are three Green PC power saving functions. They are user-configurable only during User Defined Power Management mode.

• **Doze Mode**

After the selected period of system inactivity (1 minute to 1 hour), the CPU clock runs at slower speed while all other devices still operate at full speed.

- **Standby Mode**

After the selected period of system inactivity (1 minute to 1 hour), the fixed disk drive and the video shut off while all other devices still operate at full speed.

- **Suspend Mode**

After the selected period of system inactivity (1 minute to 1 hour), all devices except the CPU shut off.

- **HDD Power Down**

After the selected period of system inactivity (1 to 15 minutes), the hard disk drive powers down while all other devices remain active.

- **Throttle Duty Cycle**

When the system enters Doze mode, the CPU clock runs only part of the time. You may select the percent of time that the clock runs.

- **PCI/VGA Active Monitor**

When enabled, any video activity restarts the global timer for Standby Mode.

- **Soft-Off by PWR-BTTN**

When set to “Instant-off”, the ATX switch can be used as a normal system power off button. When set to “Delay 4 seconds”, you need to hold the ATX switch for more than 4 seconds if you want to power off system.

- **Ring Wake Up**

This allows either setting of “Enabled” or “Disabled” for powering up the computer when the modem receives a call and the computer is in the soft-off mode.

- **LAN Wake Up**

This allows you to remotely power up your system through your network by sending a wake up frame or signal.

NOTE: This feature requires the network interface and an ATX power supply with at least 720mA +5 V standby power.

- **Time Wake Up**

This item can power on your computer at the time you selected.

- **Reload Global Timer Events**

When enabled, an event occurring on each device listed below restarts the global timer for Standby mode.

IRQ[3-7, 9-15], NMI

To enable or disable the detection of IRQ 3-7, IRQ 9-15 or NMI interrupt events for powering down state transition.

Primary IDE 0
Primary IDE 1
Secondary IDE0
Secondary IDE1
Floppy Disk
Serial Port
Parallel port

These items enable or disable the detection of IDE, floppy, serial and parallel port activities for powering down state transition. Actually it detects the read/write to/from I/O ports.

3.7 PnP/PCI Configuration Setup

This section describes configuring the PCI bus system. PCI (Personal Computer Interconnect) is a system which allows I/O devices to operate at speeds nearing the speed that CPU itself uses when communicating with its own special components. This section covers some very technical items and it is strongly recommended that only experienced users can make some changes.

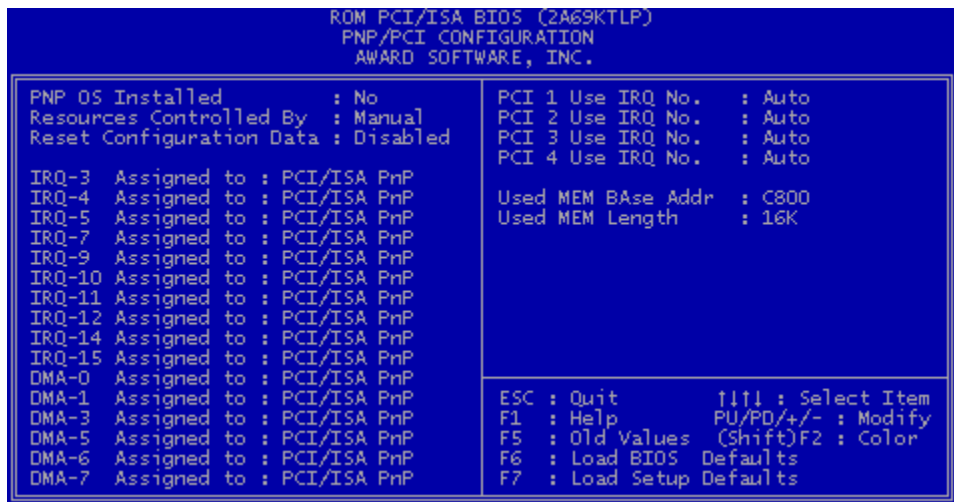

- **PNP OS Installed**

This field allows you to use a Plug-and-Play (PnP) operating system to configure the PCI bus slots instead of using the BIOS. Thus interrupts may be reassigned by the OS when “Yes” is selected. When a non-PnP OS is installed in order to prevent reassigning of interrupt settings, select the default setting of “No”.

- **Resource Controlled by**

The Award Plug and Play BIOS can automatically configure all the boot and Plug and Play(PnP) compatible devices. If you select "Auto", all the interrupt request (IRQ) and DMA assignment fields disappear, as the BIOS automatically assigns them.

The choice: Auto and Manual.

- **Reset Configuration Data**

Normally, you leave this field "Disabled". Select "Enabled" to reset Extended System Configuration Data (ESCD) when you exit "Setup", if you have installed a new add-on and the system reconfiguration has caused such a serious conflict that the operating system cannot boot.

- **IRQ-n Assigned to**

When resources are controlled manually, assign each system interrupt as one of the following types, depending on the type of device using the interrupt.

- Legacy ISA Devices, requiring a specific interrupt (such as IRQ4 for serial port1), compliant with the original PC AT bus specification.
- PCI/ISA PnP devices, whether designed for PCI or ISA bus architecture, compliant with the Plug and Play standard.

- **DMA n Assigned to**

When resources are controlled manually, assign each system DMA channel as one of the following types, depending on the type of device using the DMA.

- Legacy ISA Devices, requiring a specific DMA channel, compliant with the original PC AT bus specification,
- PCI/ISA PnP devices, whether designed for PCI or ISA bus architecture, compliant with the Plug and Play standard.

- **PCI 1,2,3,4 Use IRQ No.**

These fields set how IRQ use is determined for each PCI slot. The default setting for each field is "Auto", which uses auto-routing to determine IRQ used. The other options are manual settings of NA, 5, 7, 9, 10, 11, 12, 14 or 15 for each slot.

- **Used MEM Base Addr**

This field allows you to set the base address and block size of a legacy ISA card that uses any memory segment within the C800H and DFFFH address range. If you have more than one legacy ISA card in your system that requires to use this address range, you can increase the block size to either 8K, 16K, 32K or 64K.

3.8 Integrated Peripherals

This option will load the default BIOS values. Choose the option and the following message appears.

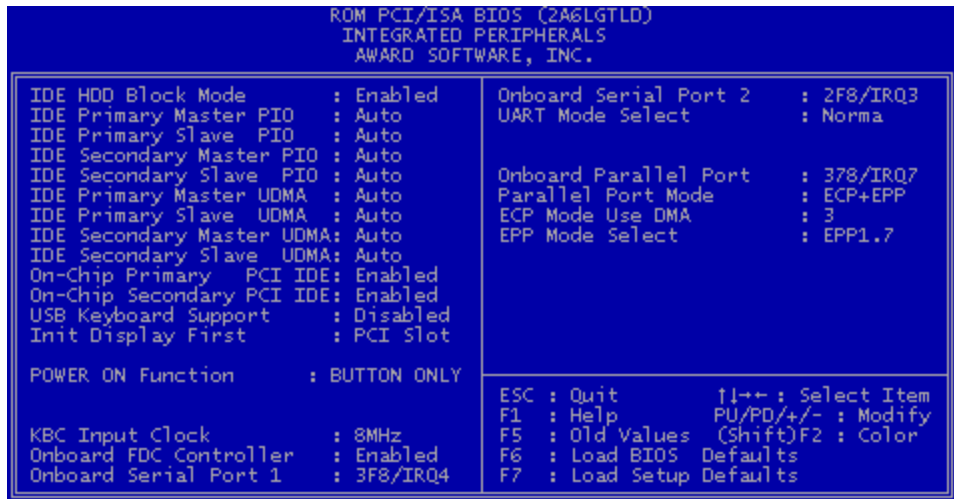

- **IDE HDD Block Mode**

The item means HDD access uses over one cycle method for improving HDD performance. If the HDD supports this function, choose "Enabled".

- **IDE Primary/Secondary Master/Slave PIO**

The four IDE PIO (Programmed Input/Output) fields let you set a PIO mode (0-4) for each of the four IDE devices that the onboard IDE interface supports. Modes 0 through 4 provide successively increased performance. In "Auto" mode, the system automatically determines the best mode for each device.

- **IDE Primary/Secondary Master/Slave Ultra DMA**

Ultra DMA/33 implementation is possible only if your IDE hard drive can support and the operating environment includes a DMA driver (Windows 95 OSR2 or a third-party IDE bus master driver). If your hard disk drive and your system software can both support Ultra DMA/33, select "Auto" to enable BIOS support.

- **On Chip IDE Primary / Secondary PCI IDE**

The chipset contains a PCI IDE interface which supports two IDE channels. Select "Enabled" to activate the first and/or second IDE interface. Select "Disabled" to deactivate an interface, if you install a primary and/or secondary add-in IDE interface.

- **USB Keyboard Support**

Select "Enabled" if you have a USB keyboard.

- **Init Display First**

This item allows you to decide to activate PCI Slot or AGP first.

- **POWER ON Function**

- 1 - Button only : Power on only by pushing button on the case (Default).
- 2 - Keyboard 98 : You can power on system by pushing Power-On key of keyboard 98.
- 3 - Password : Power on only if you key in correct password.
- 4 - Hot KEY : You can choose either of followings as hot key to power on the system.
 - A. CTRL + F1 ~ CTRL + F10
 - B. Mouse Left
 - C. Mouse Right

- **KBC Input Clock**

- 1 - 6MHz
- 2 - 8MHz
- 3 - 12MHz
- 4 - 16MHz

Set the frequency for the keyboard controller input clock.

- **Onboard FDC Controller**

You can use this function to enable or disable Onboard FDC controller.

- **Onboard Serial Port 1**

Select an address and the corresponding interrupt for each of the first and second serial ports.

The Choice: 3F8/IRQ4, 2F8/IRQ3, 3E8/IRQ4, 2F8/IRQ3, Disabled, Auto.

- **Onboard Serial Port 2**

The second serial port shares resources (address and IRQ) with IrDA.

- **UART Mode Select**

Normal : Normal operation

IrDA : IrDA compliant serial infrared port

ASKIR : Amplitude shift keyed infrared port

- **Onboard Parallel Port**

Select a logical LPT port name and matching address for the physical parallel (printer) port.

The choice: 378H/IRQ7, 278H/IRQ5, 3BCH/IRQ7, Disabled.

- **Parallel Port Mode**

This field allows you to set the operation mode of the parallel port. The setting "Normal", allows normal-speed operation but in one direction only; "EPP" allows bidirectional parallel port operation at maximum speed; "ECP" allows the parallel port to operate in bidirectional mode and at a speed faster than the maximum data transfer rate; "ECP+EPP" allows normal speed operation in a two-way mode.

3.9 Supervisor Password

This option will set the password to prevent others from making changes to your system.

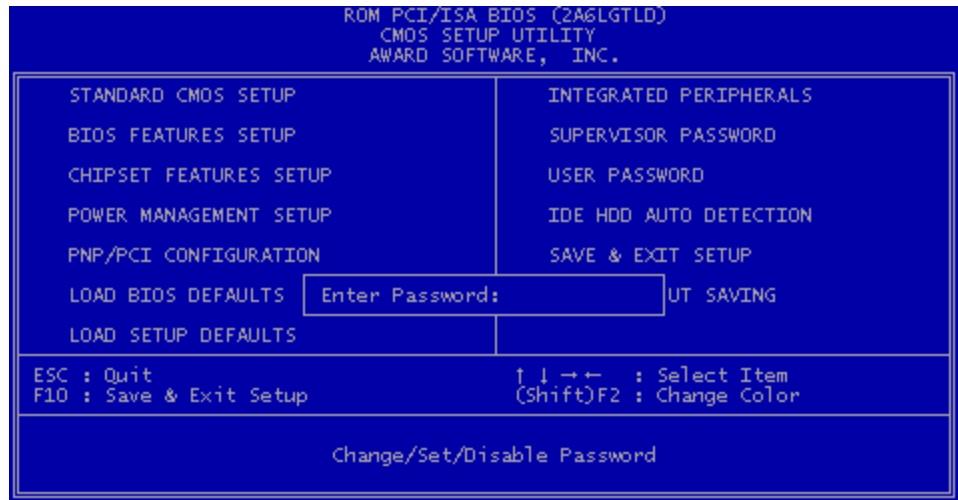

Password prevents unauthorized use of your computer. If you set a password, the system prompts for the correct password before you boot or access to “Setup”

To set a password:

1. At the prompt, type your password. Your password can be up to 8 alphanumeric characters. When you type the characters, they appear as asterisks on the password screen box.
2. After typing the password, press [Enter] key.
3. At the next prompt, re-type your password and press [Enter] key again to confirm the new password. After the password entry, the screen automatically reverts to the main screen.

To disable the password, press [Enter] key when prompted to enter the password. The screen displays a message confirming that the password has been disabled.

3.10 User Password

This option will set the password to prevent others from making changes to your system when accessed by POWER ON. This operation is same as SUPERVISOR PASSWORD.

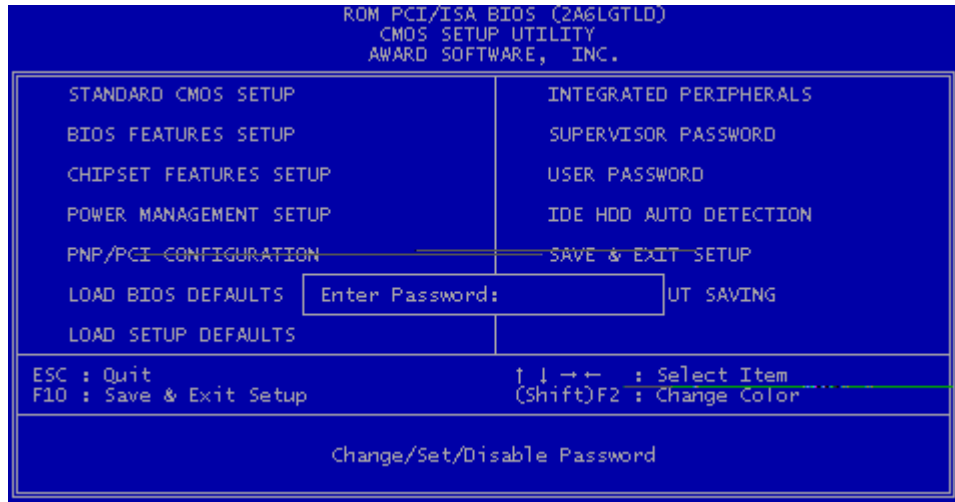

3.11 IDE HDD Auto Detection

Use the BIOS utility to detect the HDD type automatically. Press “Y” to accept, “N” to reject, and “ESC” to the next detection.

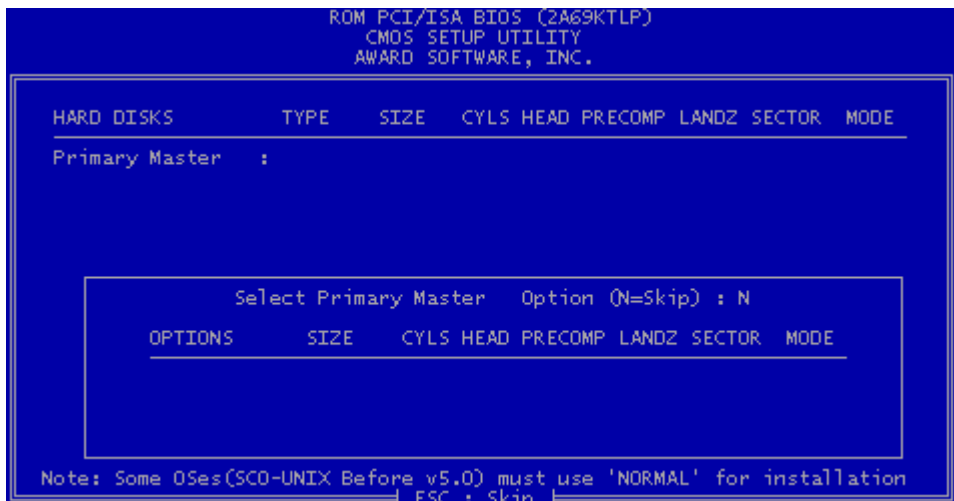

3.12 Save & Exit Setup

Save the setting and exit the BIOS utility.

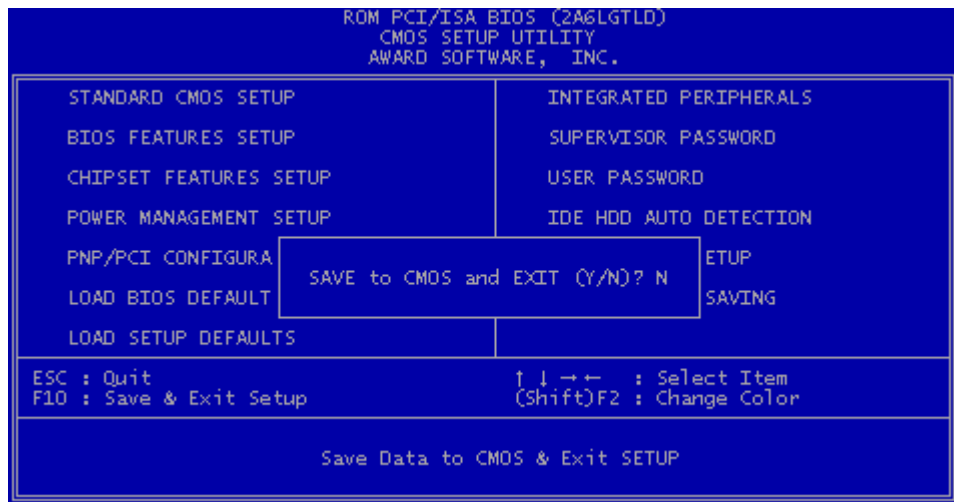

3.13 Exit Without Saving

Abort the current change and exit the BIOS utility.

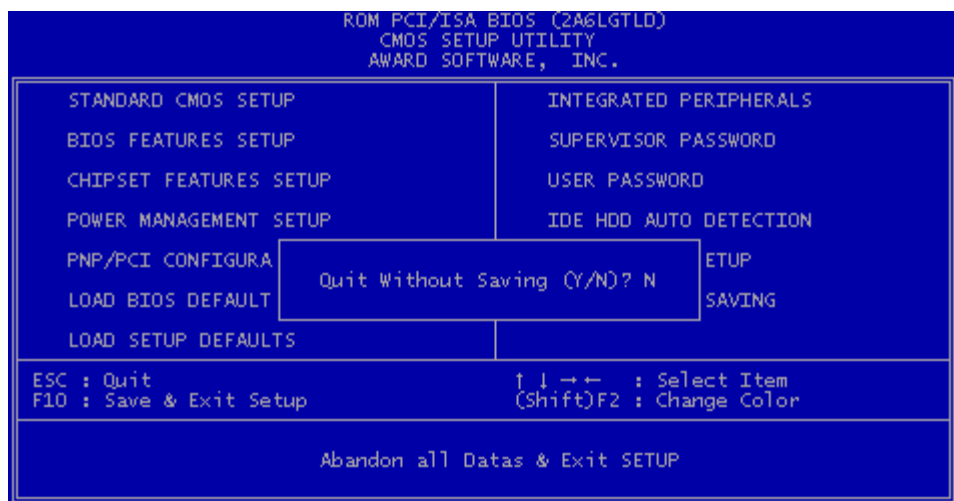

3.14 Load BIOS Defaults

NOTE: This option allows you to load the troubleshooting default values permanently stored in the BIOS ROM. These default settings are non-optimal and disable all high performance features.

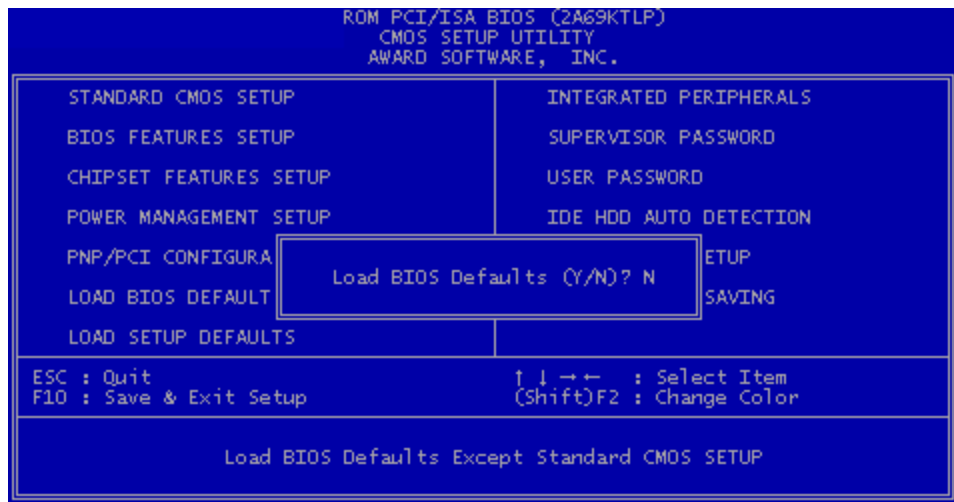

3.15 Load Setup Defaults

This option allows you to load the default values to the system configuration fields. These default values are the optimized configuration settings for the system.

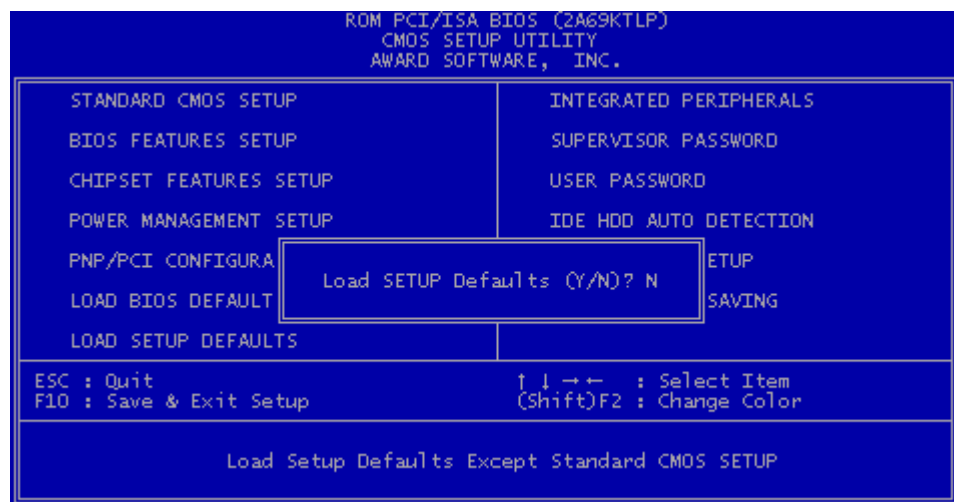

4.1 How to Check Your BIOS File Name and Version

Please turn on PC first, the screen will display as follows :

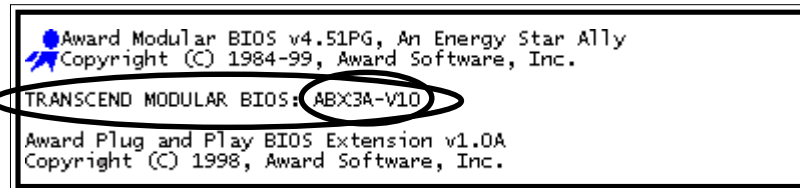

TRANSCEND MODULAR BIOS : ABX3A-V10

You can see a description shows at the third line.

ABX3A - V10

- BIOS Version 1.0 (V11 for Version 1.1)
(You can upgrade to newer version if your BIOS version is older than this version.)
- BIOS File Name
(Make sure the first 5 characters must be the same as your own version, if you want to upgrade your BIOS.)

4.2 Download Correct BIOS File from Web

Please enter Transcend Internet web : <http://www.transcendusa.com>.

Choose BIOS upgrade environment.

The BIOS file name consists of 5 characters. Check the exact BIOS to download. Your BIOS file name must absolutely match the one shown on our web. Then download the suitable version to your disk.

Warning: Your system could be damaged, if a wrong BIOS version is accidentally used. If you are not sure what version you should choose, please contact us at techsupport@transcend.com.tw

4.3 How to Update Your Motherboard BIOS

Please follow these 5 steps listed below to update your BIOS.

Step 1: Make a record of your original or existing BIOS Setup parameters.

- Press [Del] during the Power On Self Test to enter BIOS Setup Program when you start your system.
 - Write down the value of each parameter in order to re-configure your system after BIOS updating.
-

Step 2: Make a System Disk

- Put a clean 3.5" disk in Drive A

MS-DOS : Key in **FORMAT A:/S** and press [Enter].

Windows O/S : Select the icon of [My Computer]

Click [3.5" Floppy (A:)]

Select [File/Format] from Command Bar

Under **Format 3.5** Floppy (A:) **Menu** select

Format type = Full item and

Other Options = Copy system files

Click [Start] button

Step 3: Download the updated BIOS EXE file from the web site to a floppy disk.

(Ref 4.1 and 4.2)

Step 4: Execute the download file to decompress it.

Step 5: Please read the file of Readme.TXT carefully, and follow the instructions step by step.

Then you can finish the BIOS update.
