



SL-75MAV/75MAV-X V1.1

USER MANUAL

USER NOTICE

Product Model	: SL-75MAV/75MAV-X
Manual Revision	: V1.1
Release Date	: March 2001

This Users Guide & Technical Reference is for assisting system manufacturers and end-users in setting up and installing the mainboard.

Every effort has been made to ensure that the information in this manual is accurate. Soltek Computer Inc. is not responsible for printing or clerical errors. Information in this document is subject to change without notice and does not represent a commitment on the part of Soltek Computer Inc.

No part of this manual may be reproduced, transmitted, translated into any language in any form or by any means, electronic or mechanical, including photocopying and recording, for any purpose without the express written permission of Soltek Computer Inc.

Companies and products mentioned in this manual are for identification purpose only. Product names appearing in this manual may or may not be registered trademarks or copyrights of their respective companies.

Soltek computer inc. Provides this manual "As is " without warranty of any kind, either express or implied, including but not limited to the implied warranties or conditions of merchantability or fitness for a particular purpose. In no event shall Soltek computer inc. Be liable for any loss or profits, loss of business, loss of use or data, interruption of business, or for indirect, special, incidental, or consequential damages of any kind, even if Soltek computer inc. Has been advised of the possibility of such damages arising from any defect or error in this manual or product.

Copyright © 2001 Soltek Computer Inc. All Rights Reserved.

- AMD Athlon Thunderbird™, and Duron™ processors are trademarks of AMD Corporation.
- VIA, KT-133, VT8363 and VT82C686A are trademarks of VIA Corporation.
- Norton AntiVirus, Norton Ghost are trademarks of Symantec Corporation.

SOLTEK AROUND THE WORLD

SOLTEK COMPUTER INC.

Address : 7F, No. 306-3, Ta-Tung Rd, Sec.1, Hsi-Chin, Taipei-Hsien, Taiwan, R.O.C.
Telephone : 886-2-2642-9060
Fax : 886-2-2642-9065
E-mail : sales@soltek.com.tw
Web site : <http://www.soltek.com.tw>

SOLTEK KOREA INC.

Address : 1002, Chungjin Bldg. 53-5 Wonhyo-Ro, 3-Ka, Yongsan-Ku Seoul 140-113, Korea
Telephone : 82-2-32717400
Fax : 82-2-32717405
E-mail : soltek@nuri.net

SOUL TECHNOLOGY EUROPE B.V.

Address : Sydneystraat 52-54 3047 BP Rotterdam, the Netherlands
Telephone : 31-10-2457492
Fax : 31-10-2457493
E-mail : sales@soultech-europe.com
Web site : <http://www.soultech-europe.com>

CONTENTS

Chapter 1

INTRODUCTION	7
1-1 ITEM LIST CHECKUP	7
1-2 PROCESSOR	7
1-3 CHIPSET	7
1-4 ADVANCED HIGH PERFORMANCE DRAM CONTROLLER	7
1-5 INTEGRATED SAVAGE4 2D/3D VIDEO ACCELERATOR	8
1-6 FULL FEATURED ACCELERATED GRAPHICS PORTS (AGP) CONTROLLER.....	8
1-7 MULTI-I/O FUNCTION	8
1-8 EXTENSION SLOTS	8
1-9 BIOS	9
1-10 SOUND CONTROLLER	9
1-11 POWER MANAGEMENT	9
1-12 FROM FACTOR	9
1-13 HARDWARE MONITORING	9
1-14 OTHERS	9
1-14.1 MOTHERBOARD LAYOUT --- 75MAV	10
1-14.2 MOTHERBOARD LAYOUT --- 75MAV-X	11
1-15 CHIPSET DIAGRAM--- 75MAV/75MAV-X.....	12

Chapter 2

HARDWARE SETUP	13
2-1 CPU INSTALLATION	13
2-2 MEMORY INSTALLATION	14
2-3 AMD SOCKET 462 PROCESSOR MARKING IDENTIFICATION	16
2-4 ACCELERATED GRAPHICS PORT (AGP) PRO INSTALLATION ..	17
2-5 HDD / FDD INSTALLATION	18

2-6 CPU FREQUENCY (SW1)	19
2-7 BUS RATIO SELECT (SW2 DIP1-4/JP17)	20
2-8 JUMPER DEFINITIONS	21
2-8.1 ONBOARD FAN CONNECTOR (FAN1/FAN2)	21
2-8.2 USB PORT SELECT (JP1/JP2)	23
2-8.3 FACTORY (JP3).....	23
2-8.4 POWER LOST RESUME (JP7)	23
2-8.5 USB WAKE UP (JP9)	23
2-8.6 MEMORY MODULE VOLTAGE SELECT (JP10/JP11).....	24
2-8.7 CLEAR CMOS DATA (JBAT1)	25
2-8.8 WAKE ON LAN FUNCTION (WOL1)	26
2-8.9 CD-ROM AUDIO CONNECTOR (CD-IN1/CD-IN2)	27
2-8.10 THERMAL SENSOR CONNECTOR (RT2)	27
2-9 CONNECTORS	28
2-9.1 J3 AND J4	28
2-9.2 CHASSIS PANEL CONNECTOR.....	31
2-9.3 FLAT-PANEL DISPLAY CONNECTOR (DVC1)	32
2-9.4 ATX POWER SUPPLY CONNECTOR	33
2-9.5 PS/2 MOUSE AND PS/2 KEYBOARD	33
2-9.6 SERIAL PORT CONNECTORS	34
2-9.7 SECOND USB CONNECTOR	35
2-9.8 IRQ DESCRIPTION	36
2-10 VOICE DIAGNOSTIC FUNCTION---ONLY FOR 75MAV-X	37
2-10.1 VOICE DIAGNOSTIC FUNCTION (JP4/JP5)	38
2-10.2 VD-TECH CONTROLLER CHIP (JP8)	38

Chapter 3

SOFTWARE SETUP.....	40
3-1 ABOUT SUPPORT CD	40
3-2 VIA CHIPSET DRIVER INSTALLATION (4-IN-1 DRIVER)	40
3-3 ONBOARD S3® SAVAGE4™ VGA DRIVER INSTALLATION ..	43

3-3.1 INSTALL KM133 VGA DRIVER FOR WINDOWS 95/98/SE ... 43
3-3.2 INSTALL KM133 VGA DRIVER FOR WINDOWS NT4.0 43
3-3.3 INSTALL KM133 VGA DRIVER FOR WINDOWS ME 44
3-3.4 INSTALL S3® SAVAGE4™ VGA DRIVER WINDOWS 2000 .. 44
3-4 AC'97 AUDIO CODEC INSTALLATION 45
3-5 HARDWARE MONITOR INSTALLATION 46

Chapter 4

BIOS Setup 48
4-1 INTRODUCE THE BIOS 48
4-2 WHAT IS BIOS SETUP 48
4-3 HOW TO RUN BIOS SETUP 48
4-4 WHAT IS CMOS 48
4-5 WHAT IS POST 49
4-6 BIOS UPGRADE 49
4-6.1 BEFORE UPGRADE BIOS 49
4-6.2 UPGRADE PROCESS 49
4-7 CMOS SETUP UTILITY 53
4-8 STANDARD CMOS SETUP 54
4-9 ADVANCED BIOS FEATURES 57
4-10 ADVANCED CHIPSET FEATURES 62
4-11 INTEGRATED PERIPHERALS 67
4-12 POWER MANAGEMENT SETUP 71
4-13 PNP / PCI CONFIGURATION 77
4-14 SMARTDOC ANTI-BURN SHIELD 80
4-15 FREQUENCY/VOLTAGE CONTROL 83
4-16 LOAD OPTIMIZED DEFAULTS 84
4-17 SET SUPERVISOR / USER PASSWORD 85
4-18 SAVE & EXIT SETUP 86
4-19 EXIT WITHOUT SAVING 86

CHAPTER 1

INTRODUCTION

1-1 ITEM LIST CHECKUP

- Motherboard
- Support CD
- User's Manual
- Bundle Bonus Pack CD
- Bundle Bonus Pack Manual
- ATA 66/100 IDE Cable
- Temperature Sensor Cable
- RS232 Cable
- FDD Cable

1-2 PROCESSOR

- Supports AMD Athlon Thunderbird processors up to 1.5GHz
- Supports AMD Athlon Duron processors up to 1.2GHz
- Supports processor VID (voltage ID) and FID (frequency ID) auto detection
- Supports AMD Athlon processor with 200 and 266MHz Front Side bus.

1-3 CHIPSET

- North Bridge VIA VT8365A (KM-133A)
- South bridge VIA VT82C686B

1-4 ADVANCED HIGH PERFORMANCE DRAM CONTROLLER

- Supports PC133 and PC100 SDRAM and Virtual Channel Memory (VCM) SDRAM up to 3 DIMMs
- 64-bit data width and 3.3V DRAM interface
- Supports up to 1.5 GB memory space
- Different DRAM types may be used in mixed combinations
- PCI-2.2 compliant, 32 bit 3.3V PCI interface with 5V tolerant inputs

1-5 INTEGRATED SAVAGE4 2D/3D VIDEO ACCELERATOR

- Optimized Shared Memory Architecture (SMA)
- 2 to 32 MB frame buffer using system memory
- Floating point triangle setup engine
- Single cycle 128-bit 3D architecture
- 8M triangles/second setup engine
- 140M pixels/second trilinear fill rate
- Full AGP 4X, including sideband addressing and execute mode
- 2D/3D resolutions up to 1920x1440

1-6 FULL FEATURED ACCELERATED GRAPHICS PORTS (AGP) CONTROLLER

- Synchronous and pseudo-synchronous with the host CPU bus with optimal skew control PCI AGP Mode 33MHz/66MHz/100MHz DDR 3x synchronous
- Supports 66MHz 1x, 2x and 4x modes for AD and SBA signaling
- AGP v2.0 compliant

1-7 MULTI-I/O FUNCTION

- Two UltraDMA 33/66/100 Master Mode PCI EIDE ports
- Two UARTs for complete Serial Ports
- One dedicated IR connector:
 - Third serial port dedicated to IR function either through the two complete serial ports or the third dedicated port Infrared-IrDA (HPSIR) and ASK(Amplitude Shift Keyed) IR
- Multi-mode parallel connector:
 - Standard mode, ECP and EPP support
- Floppy Disk connector:
 - Two FDDs with drive swap support
- Universal Serial Bus connector:
 - USB v1.1 and Intel Universal HCI v1.1 compatible
 - Provides 2 build-in USB ports (another 2 internal USB ports for extensible purpose require an optional USB connect cable)
- PS/2 keyboard connector
- PS/2 Mouse connector

1-8 EXTENSION SLOTS

- Five PCI bus Master slots
- One ISA slot
- One DVC1 slot

- One AGP Pro 4x mode slot
- Three DIMM slots

1-9 BIOS

- Award BIOS V6.0
- Supports Plug & Play V1.0
- Flash Memory for easy upgrade
- Year 2000 compliant
- Supports BIOS writing protection
- Supports SMARTDOC ANTI-BURN SHIELD
- Supports RedStorm Overclocking Tech

1-10 SOUND CONTROLLER

- SoundBlaster Pro Hardware and Direct Sound Ready AC97 Digital Audio Controller with Codec onboard

1-11 POWER MANAGEMENT

- ACPI 1.0 compliant (Advanced Configuration and Power Interface)
- APM V1.2 compliant (legacy power management)
- Supports ACPI suspend STR mode (Suspend To RAM) and POS mode (Power On Suspend)
- Supports Wake On LAN (WOL) & Wake On Modem (WOM)
- Supports real time clock (RTC) with date alarm, month alarm, and century field
- Supports USB boot-up Function

1-12 FROM FACTOR

- ATX from factor, 4 layers PCB
- Motherboard size 22.0cm x 33.3cm

1-13 HARDWARE MONITORING

- Programmable control, status, monitor and alarm for flexible desktop management (software include)
- Five-positive voltage monitoring
- Two-temperature monitoring
- 2 Fan-speed monitoring

1-14 OTHERS

- Clock generator supports 1 MHz linear clock setting
- Supports DRAM Voltage select Function

1-14.1 MOTHERBOARD LAYOUT --- 75MAV

- Default Setting: AMD Athlon Thunderbird™ 100MHz.

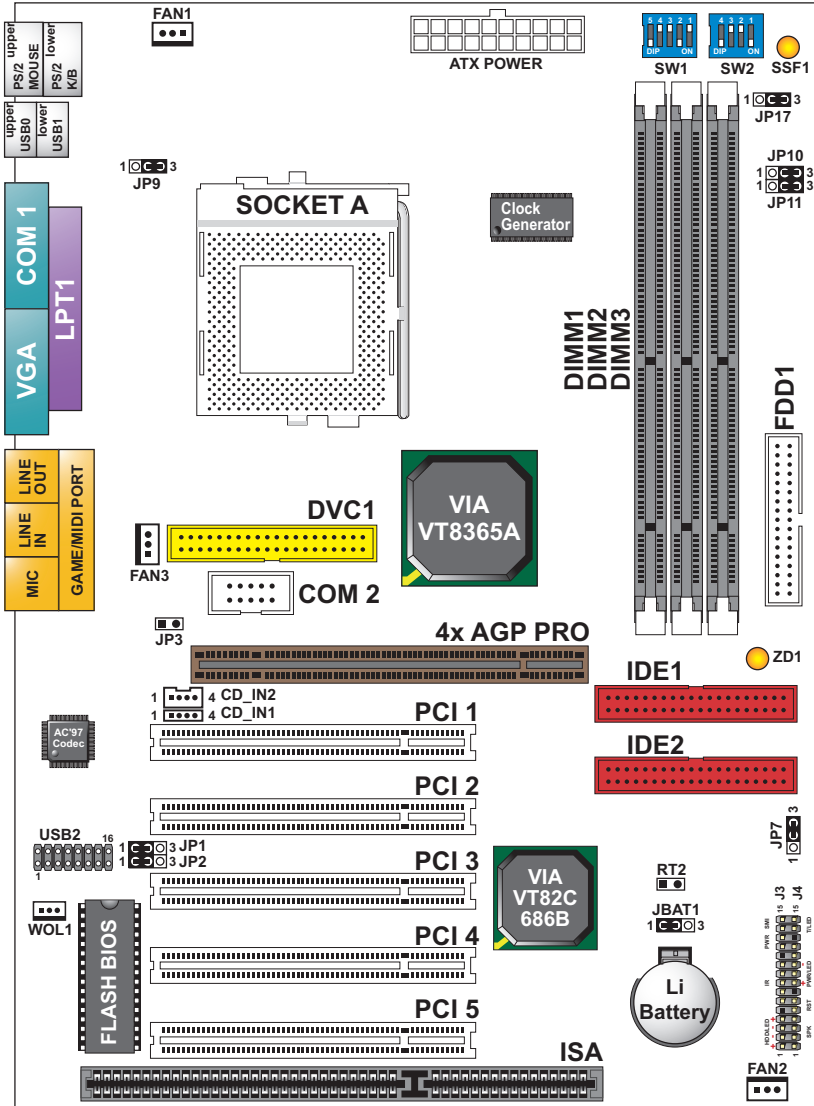

PS/2 LOWER
K/B



Clock
Generator



W5280

JP8
1

1-15 CHIPSET DIAGRAM--- 75MAV/75MAV-X

- The KM-133A / VT8365A and VT82C686B chipset is a high performance, cost-effective and energy efficient system controller for the implementation of AGP / PCI / ISA desktop personal computer system based on 64-bit Socket-A (AMD Athlon) processors.

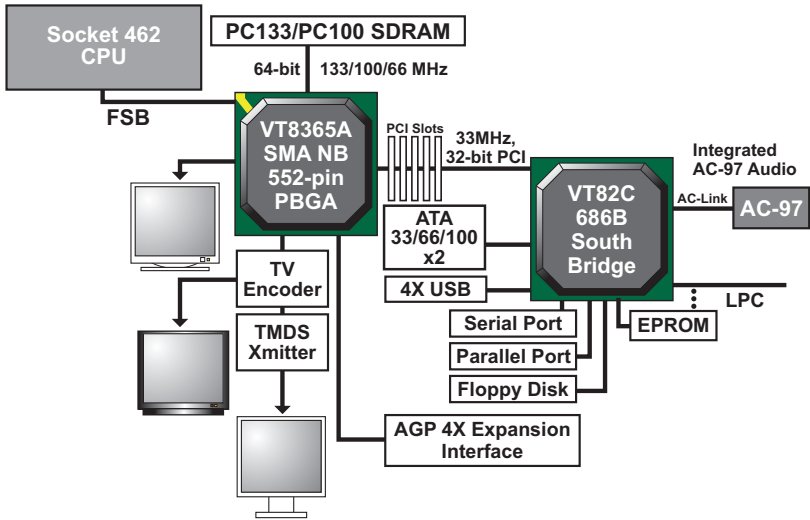

VT8365A System Block Diagram with VT82C686B PCI-TO-ISA South Bridge

CHAPTER 2 HARDWARE SETUP

2-1 CPU INSTALLATION

WARNING:

- Make sure that +5V DVC and +3.3 DVC capabilities of your power supply are suitable for the processor.
- Any attempt to operate the AMD Athlon or Duron processor without a suitable cooling Fan will result in permanent damage to the processor and potentially other component within the system.

1. Pull the lever sideways away from the socket, and then raise the lever up to a 90-degree angle.

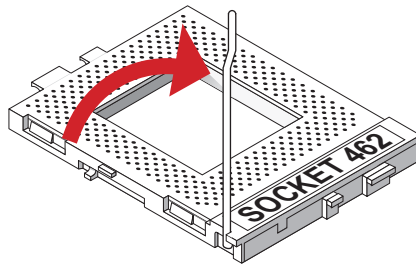

2. Take note of the red circle as below picture. While inserting the CPU into the socket, you can find out there is a definite pin orientation for CPU and socket.

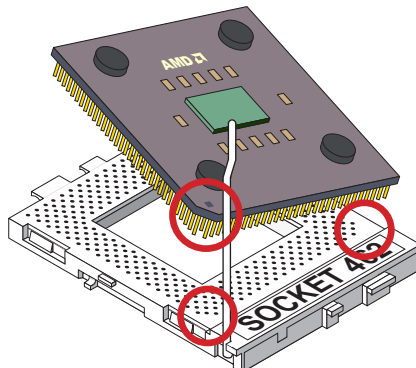

3. Make sure that the CPU position in the socket tightly, and then put the lever down to complete the CPU installation.

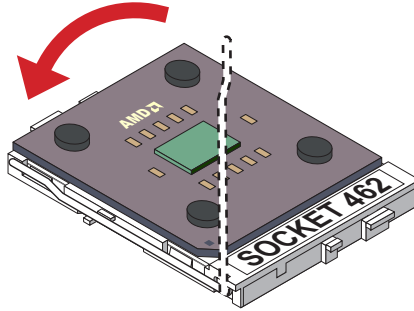

2-2 MEMORY INSTALLATION

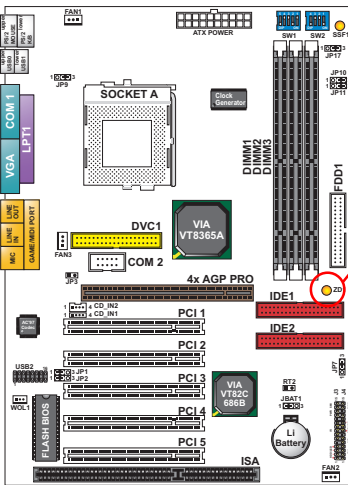

NOTICE : When LED “ZD1” light is on, meaning that 3.3V is operating and flowing into DIMM slots, please do not add or remove memory modules .

WARNING!!!

- Make sure that you unplug your power supply when adding or removing memory modules or other system components. Failure to do so may cause severe damage to both your mainboard and expansion cards.
- Be careful when inserting or removing DIMM, forcing a DIMM in or out of a socket can be damaged the memory module or the socket. Some of DIMMs contain EDO or FTP DRAM. These DIMM types are incompatible with the motherboard, the M/B only supports 3.3V true SDRAM DIMMs

Installing DIMM

- Make sure you have the correct memory module type for your motherboard.
- Insert the module(s) as shown, DIMMs have 168-pins and two notches that will match with the onboard DIMM socket, memory modules are installed by inserting them straight into the slot until they “click” into place. They only fit in one direction so do not force them into place.

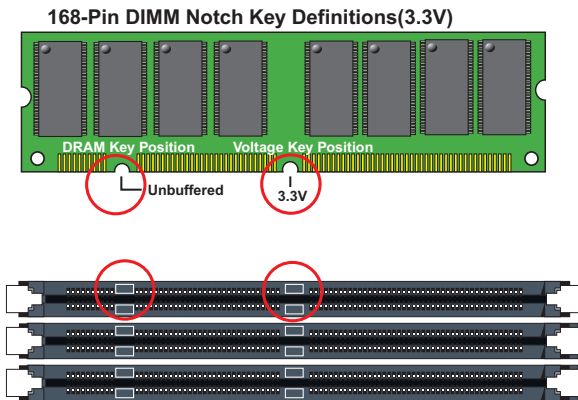
**Removing DIMM**

- Press the holding clips on both sides of socket out ward to release the DIMM out of the socket.

2-3 AMD SOCKET 462 PROCESSOR MARKING IDENTIFICATION

- The following figures and tables describe the product marking for the PGA (Socket A) versions of the AMD Athlon Model 4 processor and AMD Duron processor...

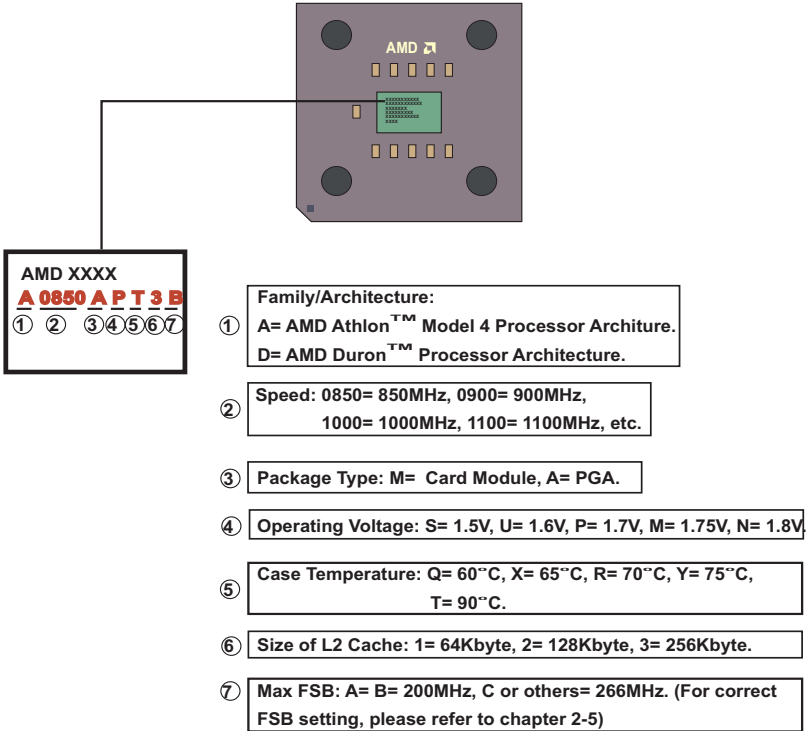

2-4 ACCELERATED GRAPHICS PORT (AGP) PRO INSTALLATION

- The AGP Pro connector is an extension of the existing AGP connector and it accepts existing AGP cards.

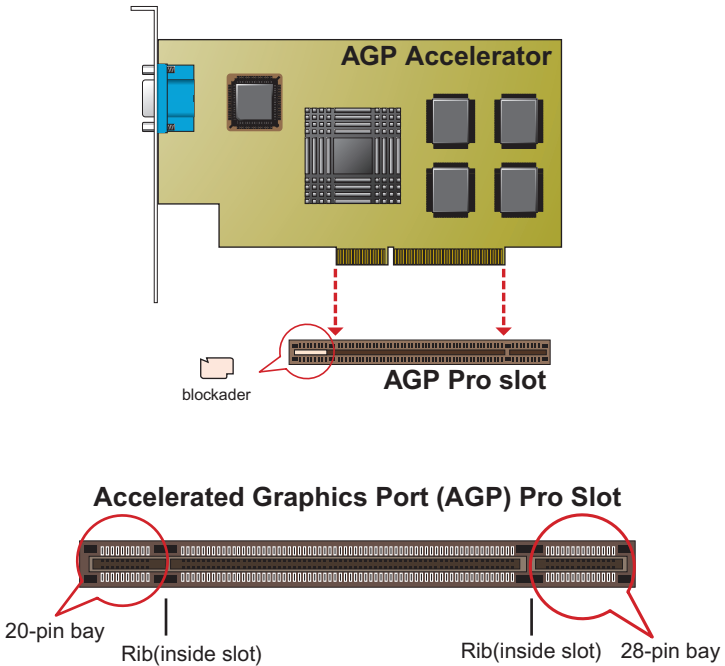

CAUTION!!

The AGP Pro slot is shipped with a warning label over the 20-pin bay. Do not remove this label and the safety tab underneath it if you will be using an AGP card without a retention notch. Removing may cause the card to shift and may cause damage to your card, slot, and motherboard. Remove ONLY when you will be using an AGP Pro card.

2-5 HDD / FDD INSTALLATION



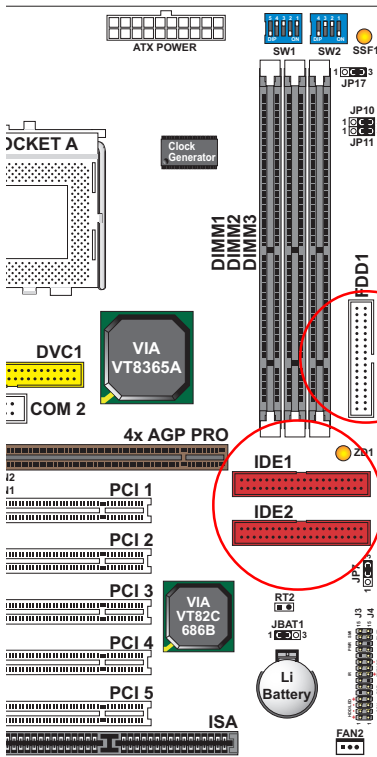







- To install HDD (Hard Disk Drive), you may connect the cable's blue connector to the motherboard's primary (IDE1) or secondary IDE connector, and then connect the gray connector to your slave device and the black connector to your master device. If you install two hard disks, you must configure the second drive to Slave mode by setting its jumper accordingly. Please refer to your hard disk documentation for the jumper settings.
- To install FDD (Floppy Disk Drive), you may connect the single end to the board, and connect two plugs on the other end to the floppy drives.



Floppy Disk Drive Connector:
Orient the red markings on the floppy ribbon cable to Pin1.

Hard Disk Drive Connector:
Orient the red markings on the IDE ribbon cable to Pin1.

2-6 CPU FREQUENCY (SW1)

SW1	CPU EXTERNAL CLOCK	PCI CLOCK	FSB CLOCK
	100MHz (default)	33.3MHz	200MHz
	103MHz	34.3MHz	206MHz
	105MHz	35.0MHz	210MHz
	110MHz	36.7MHz	220MHz
	112MHz	37.3MHz	224MHz
	115MHz	38.3MHz	230MHz
	120MHz	40.0MHz	240MHz
	124MHz	31.0MHz	248MHz
	133.3MHz	33.3MHz	266MHz
	140MHz	35.0MHz	280MHz
	150MHz	37.5MHz	300MHz

IMPORTANT:

- You may figure out the correct processor type by processor's OPN (Ordering Part Numbers), select correct CPU external frequency is key to ensure reliable operation.
- Incorrect CPU external frequency or overclocking are not guaranteed to be stable, we strongly recommended to leave "SW1" at default setting or legal operation.

2-7 BUS RATIO SELECT (SW2 DIP1-4/JP17)

- The AMD Athlon and Duron processor provides four frequency ID signals (FID) to the system controller to indicate the SYSTCLK multiplier at which the processor core operates. This mechanism is automatic. The board maker does not guarantee "Bus Ratio" can be selected if the processor does not support it.
- When LED "SSF1" light is on, meaning that Bus Ratio Select Function is enabled.

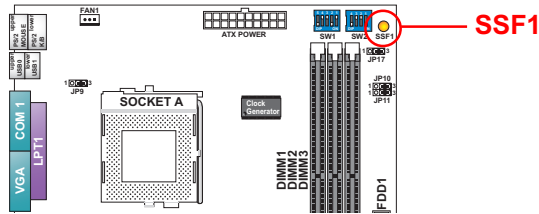

SW2 DIP1 ~ DIP4 SETTING				JP17
5.0x		5.5x		Bus ratio detected by FID (Auto) 1 <input type="radio"/> <input checked="" type="radio"/> <input type="radio"/> 3
6.0x (Default)		6.5x		
7.0x		7.5x		
8.0x		8.5x		Bus ratio selected by SW2 DIP 1-4 1 <input checked="" type="radio"/> <input type="radio"/> <input type="radio"/> 3
9.0x		9.5x		
10.0x		10.5x		JP17 allows you to enable or disable the "Frequency Ratio Select" function.
11.0x		11.5x		
12.0x		12.5x		

IMPORTANT Note:

Frequency ratio 10.5x and JP17 for PCB version F1 or above only.



2-8 JUMPER DEFINITIONS

- The figure below shows the location for the motherboard's jumper blocks.

CAUTION

- Do not move the jumper with the power on. Always turn off the power and unplug the power cord from the computer before changing the jumper. Otherwise, the motherboard could be damaged.

2-8.1 ONBOARD FAN CONNECTOR (FAN1/FAN2/FAN3)

FAN1/FAN2/FAN3: ONBOARD FAN CONNECTOR (12V)	
CPU FAN	FAN1 
SYSTEM FAN	FAN2 
CHASSIS FAN	FAN3 

Those connectors support processor/system cooling fan with +12V. Those support three pin head connector. When connecting the wire to FAN connectors, user should give attention that the red wire is the positive and should be connected to the +12V, the black wire is Ground and should be connected to GND. If your motherboard has Hardware Monitor chipset on-board, you must use a specially designed fan with speed sensor to take advantage of this function.

For fans with fan speed sensor, every rotation of the fan will send out 2 pulses. System Hardware Monitor will count and report the fan rotation speed.

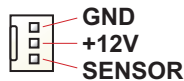

NOTE 1: Always consult vendor for proper CPU cooling fan.

NOTE 2: CPU FAN supports the FAN control. You can install PC Alert utility. This will automatically control the CPU FAN speed according to the actual CPU temperature.

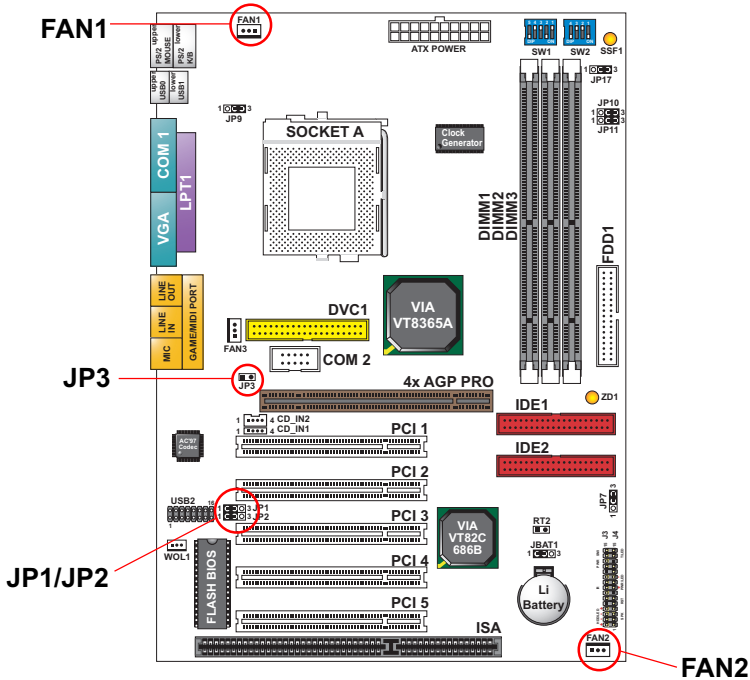



2-8.2 USB PORT SELECT (JP1/JP2)

JP1/JP2: USB PORT SELECT							
Redirect USB port 3 to USB 2 connector (default)	<table border="1"> <tr> <td>1</td> <td>3</td> </tr> <tr> <td>0</td> <td>0</td> </tr> <tr> <td>1</td> <td>3</td> </tr> </table>	1	3	0	0	1	3
1	3						
0	0						
1	3						
Redirect USB port 3 to AGP	<table border="1"> <tr> <td>1</td> <td>3</td> </tr> <tr> <td>0</td> <td>0</td> </tr> <tr> <td>0</td> <td>3</td> </tr> </table>	1	3	0	0	0	3
1	3						
0	0						
0	3						

2-8.3 FACTORY (JP3)

JP3: FACTORY TEST			
Only for factory test.	<table border="1"> <tr> <td>JP3</td> <td><input type="checkbox"/> <input checked="" type="checkbox"/></td> </tr> </table>	JP3	<input type="checkbox"/> <input checked="" type="checkbox"/>
JP3	<input type="checkbox"/> <input checked="" type="checkbox"/>		



2-8.4 POWER LOST RESUME (JP7)

JP7: POWER LOST RESUME		
Normal (default)	JP7	
Enabled	JP7	

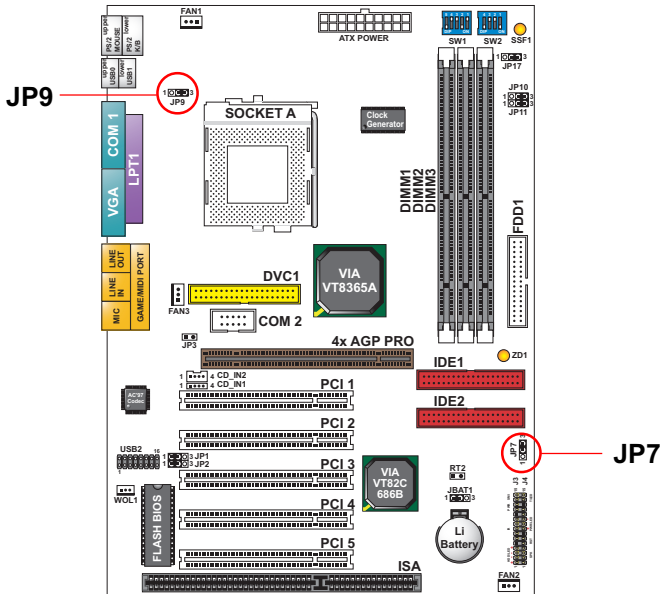
This jumper allows you to use the switch of ATX power supply to control ON/OFF switch directly instead of using the power switch on the motherboard.











2-8.5 USB WAKE UP (JP9)

JP9: USB Wake up		
Disabled (default)	JP9	
Enabled	JP9	

This function allows you to use USB mouse or keyboard to wake up the system.

2-8.6 MEMORY MODULE VOLTAGE SELECT (JP10/JP11)



JP10/JP11: MEMORY MODULE VOLTAGE SELECT	
3.3V (default)	JP10  JP11 
3.4V	JP10  JP11 
3.5V	JP10  JP11 
3.6V	JP10  JP11 

This function allows you to select the voltage supplied to the DRAM. The default voltage (3.3V) should be used unless processor overclocking requires a higher voltage.

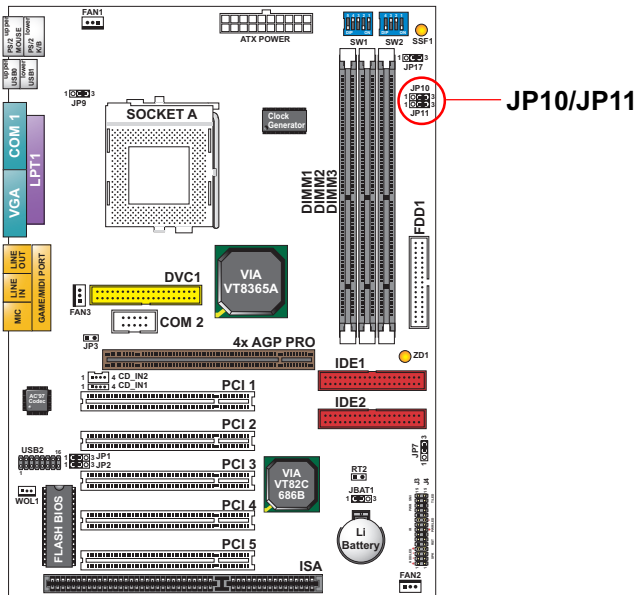
NOTE! Using a higher voltage may help when overclocking but may result in the shortening of your computer components' life. It is strongly recommended that you leave this setting on its default.



2-8.7 CLEAR CMOS DATA (JBAT1)

JBAT1: CLEAR CMOS DATA	
Clear CMOS Data	JBAT1 
Retain Data (default)	JBAT1 

A battery must be used to retain the motherboard configuration in CMOS RAM.

NOTE : You can clear CMOS by shorting 2-3 pin when the system is POWER OFF. Then, return to 1-2 pin position (default). It may damage the motherboard if clearing the CMOS in POWER ON status. Unplug the power cord from power supply before clearing CMOS will be a best bet for user.

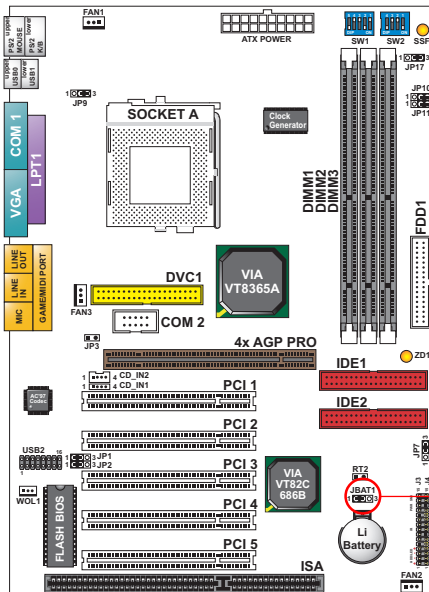

JBAT1

2-8.8 WAKE ON LAN FUNCTION (WOL1)

WOL1 : WAKE ON LAN (WOL) FUNCTION

Connect the Wake On LAN signal from LAN card to WOL1

WOL1



This connector connects to a LAN card with a Wake On LAN output. The connector powers up the system when a wake-up packet or signal is received through the LAN card.

This feature requires that Wake On LAN feature is enabled at the BIOS “Power Management Setup” and that your system has an ATX power supply with at least **720mA / +5V** standby power.

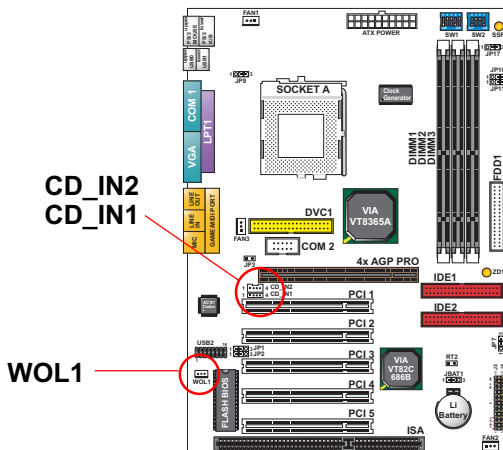

2-8.9 CD-ROM AUDIO CONNECTOR (CD-IN1/CD-IN2)

CD_IN1/CD_IN2: CD-ROM AUDIO CONNECTOR

PIN NO.	CD_IN1	CD_IN2
PIN 1	Left Channel	Left Channel
PIN 2	GND	GND
PIN 3	GND	Right Channel
PIN 4	Right Channel	GND

2-9 CONNECTORS

- In this section we list all external connectors that user will use them.

2-9.1 J3 AND J4

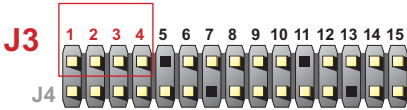

HDD LED CONNECTOR	
PIN 1	Logic High (+)
PIN 2	HDD LED SIGNAL
PIN 3	HDD LED SIGNAL
PIN 4	Logic High (+)
DESCRIPTION	This connector supplies power to the cabinet's IDE activity LED. Read and write activity by devices connected to the Primary or Secondary IDE connector will cause the LED to light up.

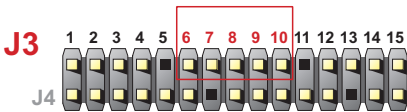

INFRARED CONNECTOR	
PIN 6	INFRARED TRANSMIT SIGNAL
PIN 7	GND
PIN 8	INFRARED RECEIVE SIGNAL
PIN 9	NONE
PIN 10	Vcc
DESCRIPTION	This connector supports an optional wireless transmitting and receiving infrared module. This module mounts to a small opening on system cases that support this feature. User must also configure the setting through BIOS program "Peripheral Setup" to select whether UART2 is directed for use with COM2 or IrDA. Use the five pins and connect a ribbon cable from the module to the motherboard's IR connector according to the pin definitions.

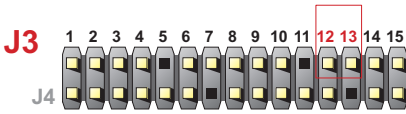

ATX POWER SWITCH	
PIN 12	ATX POWER SWITCH
PIN 13	GND
DESCRIPTION	<p>The system power is controlled by a momentary switch connected to this lead.</p> <p>Pressing the button once will switch the system between ON and SOFT OFF.</p> <p>Pushing the switch while in the ON mode for more 4 seconds will turn the system off.</p> <p>The system power LED shows the status of the system's power.</p>



SPEAKER CONNECTOR	
PIN 1	SPEAKER SIGNAL
PIN 2	NONE
PIN 3	GND
PIN 4	Vcc
DESCRIPTION	<p>This SPEAKER connector connects to the case-mounted speaker. Two sources (LINE OUT and SPEAKER) allow you to hear system beeps and warnings. Only SPEAKER allows you to hear system beeps before the integrated audio has been properly initialized.</p>

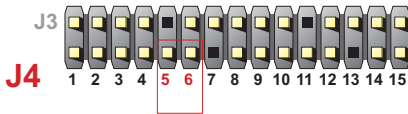

RESET SWITCH CONNECTOR	
PIN 5	RESET SIGNAL
PIN 6	GND
DESCRIPTION	RESET SWITCH connector connects to the case-mounted reset switch for rebooting your system without having to turn off your power switch. This is a preferred method of reboot to prolong the life of the system's power supply.



POWER LED CONNECTOR	
PIN 8	Vcc
PIN 9	NONE
PIN 10	GND
DESCRIPTION	This Power LED connector connects the system power LED, which lights when the system is powered on and blinks when it is in sleep mode.



SUSPEND LED	
PIN 14	SUSPEND LED SIGNAL
PIN 15	GND
DESCRIPTION	Connect to Suspend indicator light.

J3 & J4 DESCRIPTION

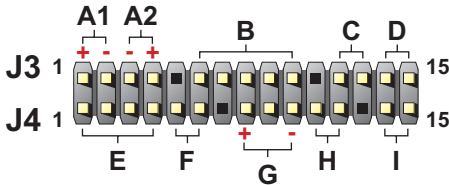

- A1 : 1st HDD LED
- A2 : 2nd HDD LED
- B : INFRARED (IR)
- C : POWER SWITCH
- D : None
- E : SPEAKER
- F : RESET SWITCH
- G : POWER LED
- H : NONE
- I : SUSPEND LED

2-9.2 CHASSIS PANEL CONNECTOR

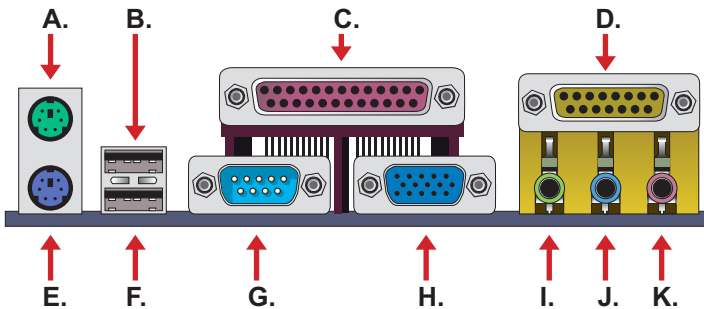

- A : PS/2 MOUSE PORT
- B : USB 0 PORT
- C : LPT 1 PORT
- D : GAME/MIDI PORT
- E : PS/2 KEYBOARD PORT
- F : USB 1 PORT
- G : COM 1 PORT
- H : VGA PORT
- I : LINE OUT/SPEAK OUT PORT
- J : LINE IN
- K : MICROPHONE

2-9.3 FLAT-PANEL DISPLAY CONNECTOR (DVC1)

- This motherboard provides a special socket “DVC1”. Which has the capability of displaying graphics on TFT flat panel desktop monitors using a 12-bit digital interface to an external encoder. The motherboard also supports auto expansion and centering of all VGA text and graphics modes to ensure that the entire flat panel display will be utilized. All resolutions are supports up to 1280x1024. The solution is Digital Visual Interface 1.0 specification compliant.

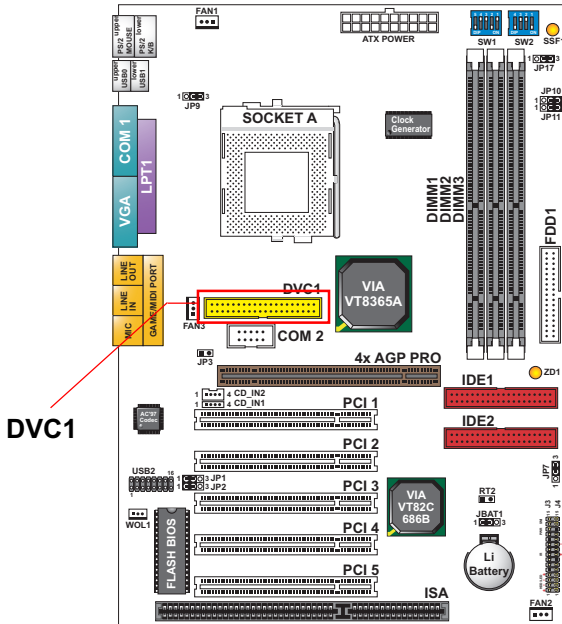

2-9.4 ATX POWER SUPPLY CONNECTOR

- This connector connects to an ATX power supply. The plug from the power supply only inserts in an orientation because of the different hole sizes. Find the proper orientation and push down firmly making sure that all pins are aligned.
- Reminding that your power supply should support at least 10mA on the 5V standby voltage. It may cause a difficulty to power on the system if the power supply can't support the load.
- **For Wake On LAN function, the power supply should support at least 720mA current.**

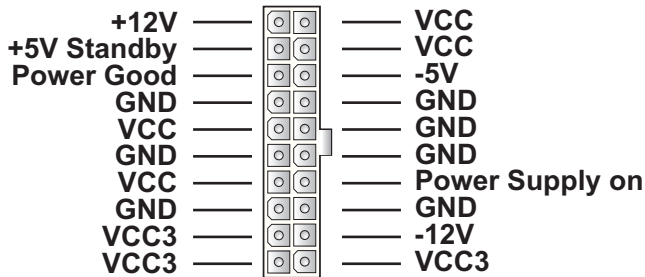

2-9.5 PS/2 MOUSE AND PS/2 KEYBOARD

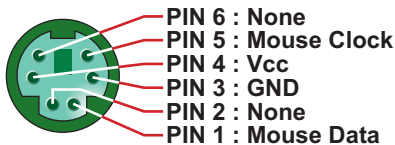

PS/2 MOUSE

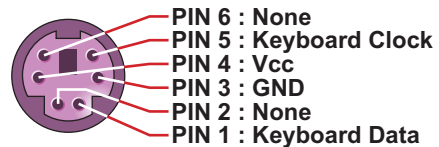

PS/2 KEYBOARD

2-9.6 SERIAL PORT CONNECTORS

- One serial port is ready for a mouse or other serial devices. A second serial port is available using a serial port bracket connected from the motherboard to an expansion slot opening.

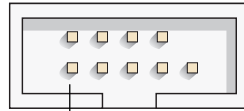
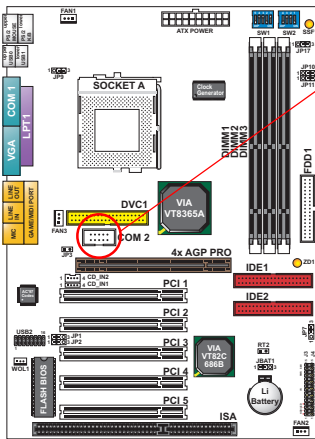

PIN1

**Serial Port Connectors:
Orient the red markings on
the floppy ribbon cable to
PIN1.**

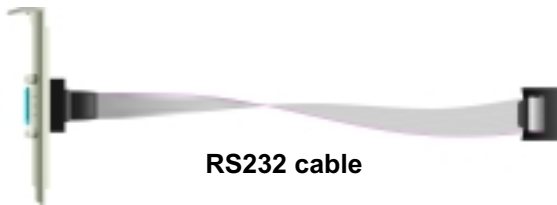

RS232 cable

2-9.7 SECOND USB CONNECTOR

- This connector is for connecting the additional USB cable. It provides you additional two USB ports. User can order the additional USB cable from your motherboard dealer and vender.

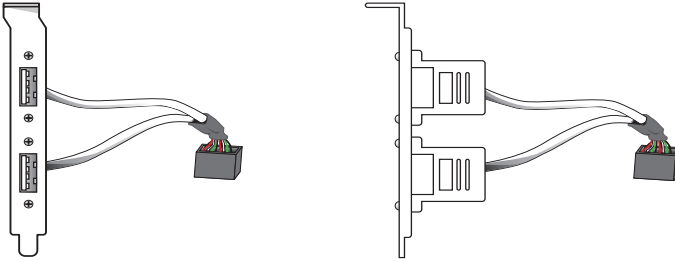

Additional USB Cable (Optional)

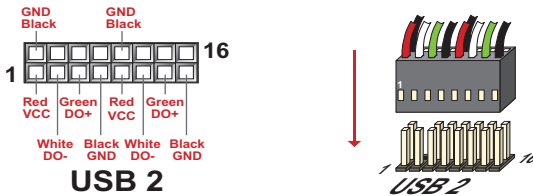

USB2 Connector (Optional)

- When plugging the USB cable to USB2 connector, user can see each color of wires to determine which is first pin.

2-9.8 IRQ DESCRIPTION

IRQ	Function Description	Priority
IRQ 0	System Timer	1
IRQ 1	Keyboard Controller	2
IRQ 2	Programmable Interrupt	N/A
IRQ 3	Serial Port (COM 2)	11
IRQ 4	Serial Port (COM 1)	12
IRQ 5		13
IRQ 6	Floppy Disk Controller	14
IRQ 7	Parallel Port (LPT1)	15
IRQ 8	Real Time Clock (RTC)	3
IRQ 9		4
IRQ 10		5
IRQ 11		6
IRQ 12	PS/2 Mouse Port	7
IRQ 13	Coprocessor	8
IRQ 14	Primary IDE Channel	9
IRQ 15	Secondary IDE Channel	10

- Both ISA and PCI expansion cards may require IRQs. System IRQs are available to cards installed in the ISA expansion bus first, then any remaining IRQs are available to PCI cards. Currently, there are two types of ISA cards.
- The original ISA expansion card design, now referred to as “Legacy” ISA card, requires that you configure the card’s jumpers manually and then install it in any available slot on the ISA bus. To see a map of your used and free IRQs in Windows 98, the *Control Panel* in *My Computer*, contains a *System* icon, which gives you a *Device Manager* tab. Double-Clicking on a specific hardware device gives you a *Resources* tab which shows the Interrupt number and address. Double-Clicking *Computers* to see all the interrupts and addresses for your system. Make sure that no two devices use the same IRQ or your computer will experience problems when those two devices are in use at the same time.

2-10 VOICE DIAGNOSTIC FUNCTION----ONLY FOR 75MAV-X

- The Voice Diagnostic Function provides user an indispensable assistance on troubleshooting while assembling your computer components. If there is any conflict or other latent problem triggers a boot-up failure, this new VD-TECH technology will voice you realistically where the conflict/problem is, then user can remove the malfunction quickly.
- This function mainly provides 4 languages and their contents as following table:

English Voice Content
<ol style="list-style-type: none"> 1. No memory module 2. Please check memory module 3. Please clear CMOS setting 4. Please check the Video adapter 5. Please check hard disk cable or setting
國語語音內容
<ol style="list-style-type: none"> 1. 未安裝記憶體 2. 請檢查記憶體 3. 請清除 CMOS 設定 4. 請檢查顯示卡 5. 請檢查硬碟接線及設定
El Contenido Español de la Voz
<ol style="list-style-type: none"> 1. No hay modulo de memoria 2. Por favor, chequea el modulo de memoria 3. Por favor, borra CMOS setting 4. Por favor, chequea la tarjeta de video 5. Por favor, chequea el cable o la instalacion del disco duro
日本語音內容
<ol style="list-style-type: none"> 1. メモリーないじゃん (メモリーがありません) 2. メモリーだめだめ (メモリーをチェックして下さい) 3. CMOS だめっす? (CMOSの内容をクリアして下さい) 4. VGA どう? (ビデオカードをチェックして下さい) 5. ハードディスクつながってる? (HDDケーブル又は設定をチェックして下さい)

2-10.1 VOICE DIAGNOSTIC FUNCTION (JP4/JP5)

JP4/JP5: VOICE DIAGNOSTIC LANGUAGE SELECT		
Chinese Language	JP4 JP5	
English Language (default)	JP4 JP5	
Japanese Language	JP4 JP5	
Spanish Language	JP4 JP5	

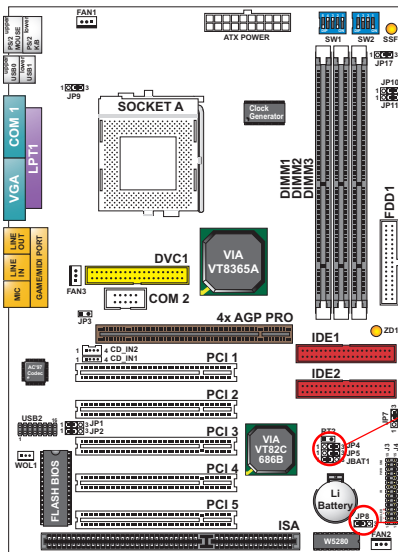

JP4/JP5

JP8

2-10.2 VD-TECH CONTROLLER CHIP (JP8)

JP8: VD-TECH CONTROLLER CHIP		
Enabled (default)	JP8	
Disabled	JP8	

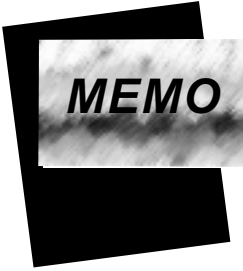

CHAPTER 3 SOFTWARE SETUP

3-1 ABOUT SUPPORT CD

- In support CD, it contains most informations for user's requirement, such as Acrobat Reader, BIOS, User's full version Manual, Driver, Hardware Monitor(if motherboard supports this function), Patch, and Utilities etc,. User can browse the CD and get further details in regard of our motherboard. Of course, welcome to vendor's website for the newest release.

3-2 VIA CHIPSET DRIVER INSTALLATION (4-IN-1 DRIVER)

Step 1:

- Please put the support CD attached to motherboard into the CD-ROM drive.
- When appears a welcome window as left screen, then user should choose "**Install Driver**"

Step 2:

- Click on the "**VIA Chipset Driver**".

Step 3:

- Click on the "**4-in-1 driver**".

Step 4:

- Click on the "**Install via 4-in-1 driver**" to continue.



Step 5:

- Press **Next** button to continue.

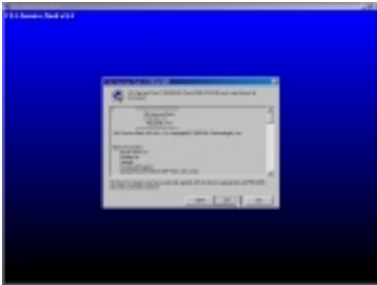

Step 6:

- Click "Yes" to continue.



Step 7:

- Press select the checkbox as below:
 - Bus Master PCI IDE Driver
 - AGP VxD Driver
 - VIA Chipset Function's Registry
 - IRQ Routing Miniport Driver

Note: For user who are upgrading VIA Drivers. We recommend installing the 4-in-1 as it will automatically detect and update the necessary drivers.

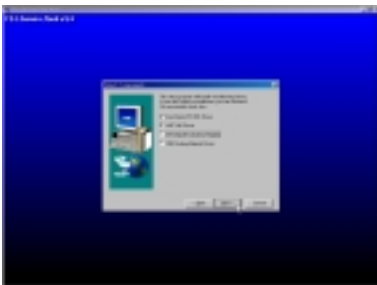

Step 8:

- Click "**Install**" and press **Next** button to continue.

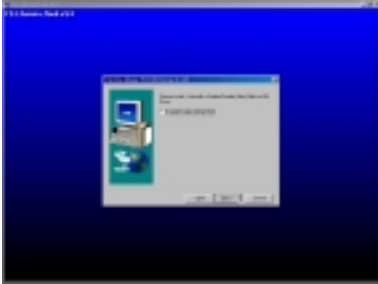

Step 9:

- Click on the “click to enable DMA mode” checkbox for enable DMA function.

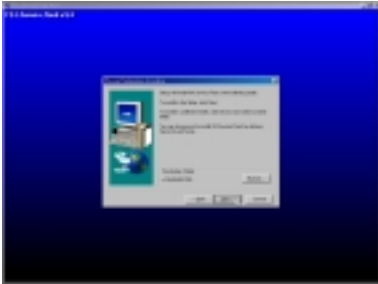

Step 10:

- The default setup destination is **C: \VIADMATool**, press **Next** button to continue.



Step 11:

- Press **Next** button to continue.

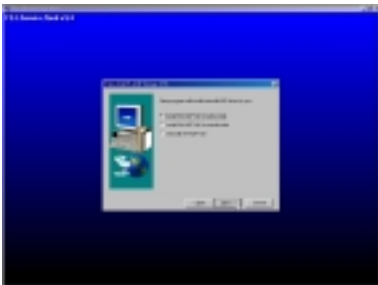

Step 12:

- Select “**Install VIA AGP VxD**” in turbo mode and press **Next** button to continue.



Step 13:

- After all the setup process is finished, please restart your computer by clicking on **Finish**.

3-3 ONBOARD S3® SAVAGE4™ VGA DRIVER INSTALLATION

- We provide a simple process for user to install the S3® Savage4 VGA driver. Whichever Microsoft Windows operating system user adopts, they have similar installation below.

3-3.1 INSTALL KM133 VGA DRIVER FOR WINDOWS 95/98/SE

1. Please put the Support CD attached to motherboard into the CD-ROM drive. When appears a welcome window as left screen, then user should choose *"Install Driver"*.
2. Click on the *"VIA chipsets Driver"*.
3. Click on the *"VIA KM133 VGA Driver"* to continue.
4. Click on the *"Install VGA Driver for Win95/98/SE"*.
5. Follow the instruction on screen to complete the installation, after which please restart your PC.

3-3.2 INSTALL KM133 VGA DRIVER FOR WINDOWS NT4.0

1. Please put the Support CD attached to motherboard into the CD-ROM drive. When appears a welcome window as left screen, then user should choose *"Install Driver"*.
2. Click on the *"VIA chipsets Driver"*.
3. Click on the *"VIA KM133 VGA Driver"* to continue.
4. Click on the *"Install VGA Driver for NT4.0"*.
5. Follow the instruction on screen to complete the installation, after which please restart your PC.

3-3.3 INSTALL KM133 VGA DRIVER FOR WINDOWS ME

1. Please put the Support CD attached to motherboard into the CD-ROM drive. When appears a welcome window as left screen, then user should choose *"Install Driver"*.
2. Click on the *"VIA chipsets Driver"*.
3. Click on the *"VIA KM133 VGA Driver"* to continue.
4. Click on the *"Install VGA Driver for Windows ME"*.
5. Follow the instruction on screen to complete the installation, after which please restart your PC.

3-3.4 INSTALL KM133 VGA DRIVER WINDOWS 2000

1. Please put the Support CD attached to motherboard into the CD-ROM drive. When appears a welcome window as left screen, then user should choose *"Install Driver"*.
2. Click on the *"VIA chipsets Driver"*.
3. Click on the *"VIA KM133 VGA Driver"* to continue.
4. Click on the *"Install VGA Driver for Win2000"*.
5. Follow the instruction on screen to complete the installation, after which please restart your PC.

3-4 AC'97 AUDIO CODEC INSTALLATION

Step 1:

- Please put the support CD attached to motherboard into the CD-ROM drive.
- When appears a welcome window as left screen, then user should choose **"Install Driver"**

Step 2:

- Click on the **"VIA Chipset Driver"**.

Step 3:

- Click on the **"AC'97 driver"**.

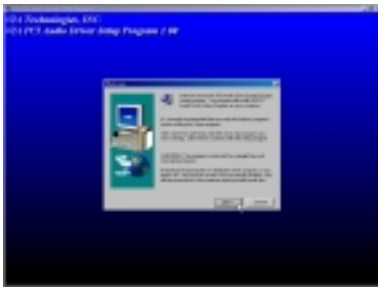

Step 4:

- Press **Next** button to continue.

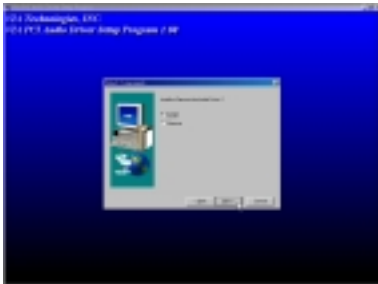

Step 5:

- When asking you install or remove the audio driver, please select **"Install"** and press **Next** button to continue.

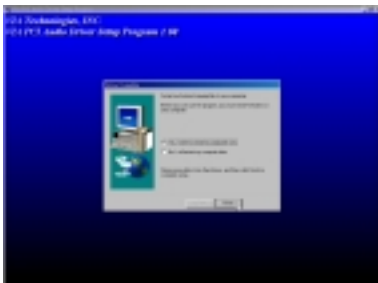

Step 6:

- It's recommended for user to restart the computer after the audio driver is finished. Please select **"Yes, I want to restart my computer now"**.

3-5 HARDWARE MONITOR INSTALLATION

Step 1:

- Please put the support CD attached to motherboard into the CD-ROM drive.
- When appears a welcome window as left screen, then user should choose “**Install Driver**”

Step 2:

- Click on the “**VIA Chipset Driver**”.

Step 3:

- Click on the “**Hardware Monitor Utility**”.



Step 4:

- Press **Next** button to continue.

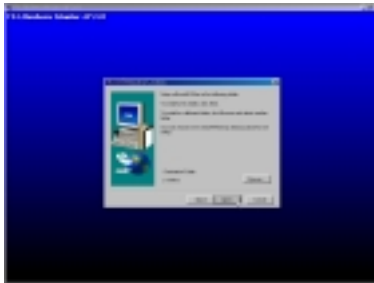

Step 5:

- The default destination is **C:\VIAhm**, then press **Next** button to continue.



Step 6:

- Press **Next** button to finish the Hardware Monitor setup process.



CHAPTER 4

BIOS SETUP

4-1 INTRODUCE THE BIOS

- BIOS stands for Basic Input Output System. It is sometimes called ROM BIOS because it is stored in a Read-Only Memory(ROM) chip on the motherboard. BIOS is the first program to run when you turn on your computer.
- BIOS performs the following functions:
 1. Initializing and testing hardware in your computer(a process called “POST”, for Power On Self Test).
 2. Loading and running your operating system.
 3. Helping your operating system and application programs to manage your PC hardware by means of a set of routines called BIOS Run-Time Service.

4-2 WHAT IS BIOS SETUP

- Setup is an interactive BIOS program that you need to run when:
 1. Changing the hardware on your system. (for example: installing a new Hard Disk etc.,)
 2. Modifying the behavior of your computer. (for example: changing the system time or date, or turning special features on or off etc.,)
 3. Enhancing your computer’s behavior. (for example: speeding up performance by turning on shadowing or caching)

4-3 HOW TO RUN BIOS SETUP

- One way of running SETUP is to press a special function key or key combination during POST, before the operating system is loaded during POST, the BIOS usually displays a prompt such as:

Press DEL to enter SETUP

4-4 WHAT IS CMOS

- CMOS is a special kind of memory maintained by a battery after you turn your computer off. The BIOS uses CMOS to store the settings you selected

in SETUP. The CMOS also maintains the internal clock. Every time you turn on your computer, the BIOS Looks in CMOS for the settings you selected and configures your computer accordingly. If the battery charge runs too low, the CMOS content will be lost and POST will issue a “CMOS invalid” or “CMOS checksum invalid” message. If this happens, you may have to replace the battery. After the battery is replaced, the proper settings will need to be stored in SETUP.

4-5 WHAT IS POST

- POST is an acronym for Power On Self Test. It's a traditional name for the routines that the BIOS uses to test and initializes the devices on your system when the PC is powered on. Its meanings has grown to include anything the BIOS does before the operating system is started. Each of POST routines is assigned a POST code, an unique number which is sent to I/O port 080h before the routine is executed.

4-6 BIOS UPGRADE

- Motherboards incorporate the system BIOS in a Flash memory component. Flash BIOS allows user upgrades without the need to replace an EPROM component.
- The upgrade utility fits on a floppy diskette and provides the capability to save, verify, and update the system BIOS. The upgrade utility can be run from a hard disk drive or a network drive, but no memory managers can be installed during upgrades.

4-6.1 BEFORE UPGRADE BIOS

- It is recommended that you save a copy of the original motherboard BIOS along with a Flash EPROM Programming utility(AWDFLASH.EXE) to a bootable floppy disk in case you need to reinstall the BIOS later.

4-6.2 UPGRADE PROCESS

Note: Normally, to upgrade BIOS that is unnecessary if the system is working fine without any problem, user should upgrade the BIOS unless you experienced incompatible problem or need BIOS upgrade to create new features. However, please read all information in this section before upgrading.

“AWDFLASH.EXE” is a Flash EPROM Programming utility that up dates the BIOS by uploading a new BIOS file to the programmable flash ROM on the motherboard, This program only works in **pure DOS environment, the utility can not be worked in win95/98, ME, NT or WINDOWS 2000 environment.**

Upgrading the system BIOS

- Set 1. Please visit the board maker’s website, download the newest BIOS file and newest award flash utility “AWDFLASH.EXE” for the motherboard. The BIOS file you downloaded will be a *.bin format.
- Step 2. Create a bootable diskette. Then copy the BIOS file and award flash utility “AWDFLASH.EXE” into the diskette.
- Step 3. Insert the diskette into drive A, reboot your system and boot from the diskette.
- Step 4. When booting is finished type **awdf flash *.bin /sn/py/cc** and then press <Enter> to run BIOS upgrade program. (*.bin depends on your motherboard model and version code).
- Step 5. After upgraded, please press <F1> or <F10> to exit or reset your system, **Warning !** If there appears **Write Fail** while Award “FLASH MEMORY WRITER” verifying Flash memory, just repeat the process, please DO NOT reset or turn off the system. If the award memory flash utility was not able to update the BIOS successfully, your system may not be able to boot up,
- Step 6. You will see a message “CMOS checksum error-Default loaded” during booting the system. Please press to run CMOS setup utility, then reload “LOAD SETUP DEFAULTS” or “**Load Optimized Defaults**” and save this change.

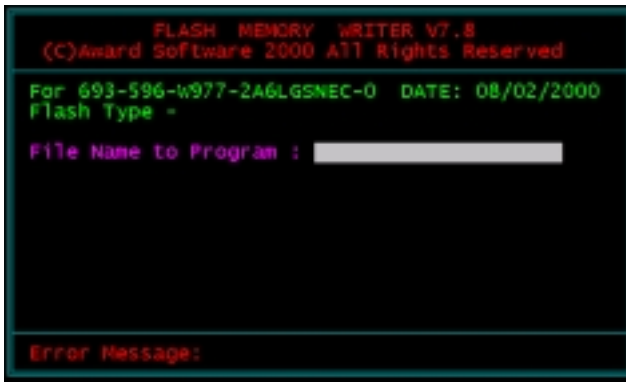

Award Flash Memory Writer Start Screen

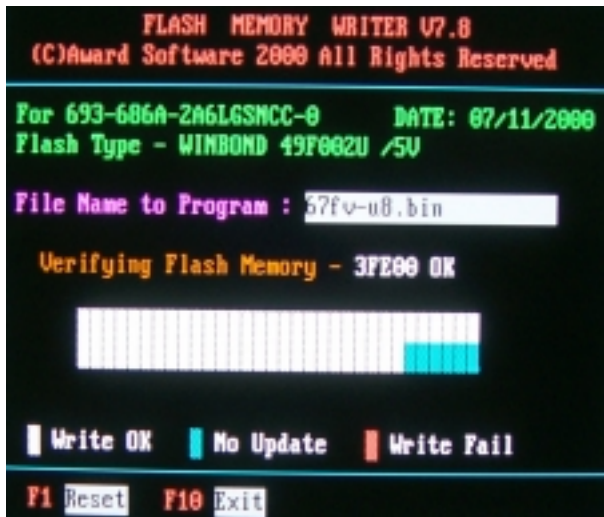

Award Flash Memory Writer Complete Screen

The parameters of AWDFLASH.EXE

/sn: No original BIOS backup

/py: Program flash memory

/cc: Clear CMOS data after programming

NOTE: User can type AWDFLASH /? to get further details about parameters. Wrong usage of parameter will damage the BIOS information, so that we strongly recommend user to leave parameters away unless you realize their function.

4-8 STANDARD CMOS SETUP

- Standard CMOS Setup allows you to record some basic system hardware configuration and set the system clock and error handling. You only need to modify the configuration values of this option when you change your system hardware configuration or the configuration stored in the CMOS memory gets lost or damaged.

Run the STANDARD CMOS SETUP as following:

- Choose "STANDARD CMOS SETUP" from the Main Menu and a screen with a list of option will appear:

CMOS Setup Utility - Copyright (C) 1984-2001 Award Software
Standard CMOS Features

		Item Help
Date (mm:dd:yy)	Tue, Oct 21 2000	
Time (hh:mm:ss)	9 : 52 : 15	Menu Level ▶
▶ IDE Primary Master	Press Enter 13022 MB	
▶ IDE Primary Slave	Press Enter None	
▶ IDE Secondary Master	Press Enter None	
▶ IDE Secondary Slave	Press Enter None	
Drive A	1.44M, 3.5 in.	
Drive B	None	
Video	EGA/VGA	
Halt On	All,But Keyboard	
Base Memory	640K	
Extended Memory	31744K	
Total Memory	32768K	

↑↓→←:Move Enter:Select +/-/PU/PD:Value F10:Save ESC:Exit F1:General Help
F5:Previous Values F6:Fail-Safe Defaults F7:Optimized Defaults

- Use one of the arrow keys to move between options and modify the selected options by using PgUp / PgDn / + / - keys.

- Date (mm:dd:yy)** The BIOS determines the day of the week from the other date information. This field is for information only.
Press the left or right arrow key to move to the desired field (date, month, year). Press the PgUp or PgDn key to increment the setting, or type the desired value into the field.
- Time (hh:mm:ss)** The time format is based on the 24-hour military-time clock. For example, 1 p.m. is 13:00:00. Press the left or right arrow key to move to desired field. Press the PgUp or PgDn key to increment the setting, or type the desired value into the field.
- Primary / Secondary Master / Slave** This field records the specifications for all non-SCSI hard disk drives installed in your system. Refer to the respective documentation on how to install the drives.
- Drive A / Drive B** Set this field to the type(s) of floppy disk drive(s) installed in your system. The choices are:
360KB, 5.25in.,
1.2MB, 5.25in.,
720KB, 3.5in.,
1.44MB, 3.5in.,
2.88MB, 3.5in.,
None.
- Video** Set this field to the type of video display card installed in the system. The choices are:
Monochrome,
Color 40x25,
VGA / EGA,
Color 80x25.
- Halt On** Set this warning feature for the type of errors that will cause the system to halt. The choices are:
No Errors,
All, But Keyboard,
All, But Diskette,
All, But Disk / Key.

CMOS Setup Utility - Copyright (C) 1984-2001 Award Software
 IDE Primary Master

IDE HDD Auto-Detection	Press Enter	Item Help
IDE Primary Master	Auto	Menu Level ▶
Access Mode	Auto	
Capacity	10243 MB	
Cylinder	19846	
Head	16	
Precomp	65535	
Landing Zone	19845	
Sector	63	

↑↓→←:Move Enter:Select +/-/PU/PD:Value F10:Save ESC:Exit F1:General Help
 F5:Previous Values F6:Fail-Safe Defaults F7:Optimized Defaults

3. Press <ESC> to return to the Main Menu when you finish setting up all items.

4-9 ADVANCED BIOS FEATURES

- ADVANCED BIOS FEATURES allows you to improve your system performance or set up system features according to your preference.

Run the ADVANCED BIOS FEATURES as following:

1. Choose “ADVANCED BIOS FEATURES” from the Main Menu and a screen with a list of option will appear:
2. Use one of the arrow keys to move between options and modify the selected options by using PgUp / PgDn / + / - keys. An explanation of the <F> keys follows:

<F1>: “Help” gives options available for each item.

<F5>: Get the previous values. These values are the values with which the user started in the current session.

<F6>: Load all options with the BIOS default values.

<F7>: Load all options with the Setup default values.

CMOS Setup Utility - Copyright (C) 1984-2001 Award Software
Advanced BIOS Features

		Item Help
Virus Warning	Disabled	Menu Level ▶
CPU Internal Cache	Enabled	
External Cache	Enabled	
CPU L2 Cache ECC Checking	Enabled	
Quick Power On Self Test	Enabled	
First Boot Device	Floppy	
Second Boot Device	HDD-0	
Third Boot Device	LS120	
Boot Other Device	Enabled	
Swap Floppy Drive	Disabled	
Boot Up Floppy Seek	Enabled	
Boot Up NumLock Status	On	
Gate A20 Option	Fast	
Typematic Rate Setting	Disabled	
× Typematic Rate (Chars/Sec)	6	
× Typematic Delay (Msec)	250	
Security Option	Setup	
OS Select For DRAM > 64MB	Non-OS2	
Video BIOS Shadow	Enabled	
C8000-CBFFF Shadow	Disabled	
CC000-CFFFF Shadow	Disabled	
D0000-D3FFF Shadow	Disabled	
D4000-D7FFF Shadow	Disabled	
D8000-DBFFF Shadow	Disabled	
DC000-DFFFF Shadow	Disabled	

↑ ↓ → ← : Move Enter: Select +/-/PU/PD: Value F10: Save ESC: Exit F1: General Help
F5: Previous Values F6: Fail-Safe Defaults F7: Optimized Defaults

Virus Warning Enabled: Activates automatically when the system boots up causing a warning message to appear if there is anything attempting to access the boot sector or hard disk partition table.

Disabled: No warning message will appear when there is something attempting to access the boot sector or hard disk partition table.

NOTE: *Many diagnostic (or boot manager) programs which attempt to access the boot sector table can cause the above warning message. If you will be running such a program, we recommend that you disable the virus protection first.*

CPU Internal Cache/ External Cache Cache memory is additional memory that is much faster than conventional DRAM (system memory). CPUs from 486-type on up contain internal cache memory, and most, but not all, modern PCs have additional (external) cache memory. When the CPU requests data, the system transfers the requested data from the main DRAM into cache memory, for even faster access by the CPU.

The External Cache field may not appear if your system does not have external cache memory.

CPU L2 Cache ECC Checking When you select *Enabled*, memory checking is enable when the external cache contains ECC SRAMs. The choice: Enabled, Disabled.

Quick Power On Self Test Select *Enabled* to reduce the amount of time required to run the power-on self -test (POST). A quick POST skips certain steps. We recommend that you normally disable quick POST. Better to find a problem during POST than lost data during your work.

First/Second/Third/ Other Boot Device The BIOS attempts to load the operating system from the devices in the sequence selected in these items. The choice: Floppy, LS/ZIP, HDD, SCSI, CDROM, Disabled.

- Swap Floppy Drive** This field is effective only in systems with two floppy drives. Selecting Enabled assigns physical drive B logical drive A, and physical drive A to logical drive B.
- Boot Up Floppy Seek** Enabled : During POST, BIOS checks the track number of the floppy disk drive to see whether it is 40 or 80 tracks.
Disabled: During POST, BIOS will not check the track number of the floppy disk drive.
- Boot Up NumLock Status** Toggle between On or Off to control the state of the NumLock key when the system boots. When toggled On, the numeric keypad generates numbers instead of controlling cursor operations.
- Gate A20 Option** Gate A20 refers to the way the system addresses memory above 1 MB (extended memory). When set to *Fast*, the system chipset controls Gate A20. When set to *Normal*, a pin in the keyboard controller controls Gate A20. Setting Gate A20 to Fast improves system speed, particularly with OS/2 and Windows.
- Typematic Rate Setting** When *Disabled*, the following two items (Typematic Rate and Typematic Delay) are irrelevant. Keystroke repeat at a rate determined by the keyboard controller in your system.
When *Enabled*, you can select a typematic rate and typematic delay.
- Typematic Rate (Chars / Sec)** Range between 6 and 30 characters per second. This option controls the speed of repeating keystrokes.
- Typematic Delay (Msec)** Choose 250, 500, 750 and 1000. This option sets the time interval for displaying the first and the second characters.
- Security Option** If you have set a password, select whether the password is required every time the System boots, or only when you enter setup.

OS Select For DRAM > Non-OS/2 : For Non-OS/2 system.
64MB OS: For OS/2 operating system.

Video BIOS Shadow Enabled copies Video BIOS to shadow RAM for improving performance.
The choice: Enabled, Disabled.

C8000-CBFFF to DC000-DFFFF Shadow These options are used to shadow other expansion card ROMs.

3. Press <ESC> to return to the Main Menu when you finish setting up all items.

4-10 ADVANCED CHIPSET FEATURES

- ADVANCED CHIPSET FEATURES allows you to change the values of chipset registers. These registers control the system options.

Run the ADVANCED CHIPSET FEATURES as following:

1. Choose “ADVANCED CHIPSET FEATURES” from the Main Menu and a screen with a list of option will appear:
2. Use one of the arrow keys to move between options and modify the selected options by using PgUp / PgDn / + / - keys. An explanation of the <F> keys follows:

<F1>: “Help” gives options available for each item.

<F5>: Get the previous values. These values are the values with which the user started in the current session.

<F6>: Load all options with the BIOS default values.

<F7>: Load all options with the Setup default values.

CMOS Setup Utility - Copyright (C) 1984-2001 Award Software
Advanced Chipset Features

		Item Help
DRAM Timing By SPD	Enabled	Menu Level ▶
DRAM Clock	100MHZ	
SDRAM Cycle Length	3	
Bank Interleave	Disabled	
DRAM Drive Strength	Auto	
×DRAM Drive Value	2F	
Memory Hole	Disabled	
PCI Master Pipeline Req	Enabled	
P2C/C2P Concurrency	Enabled	
Fast R-W Turn Around	Disabled	
System BIOS Cacheable	Disabled	
Video RAM Cacheable	Disabled	
Frame Buffer size	8M	
AGP Aperture Size	128M	
AGP 4X Mode	Enabled	
×AGP Driving Control	Auto	
AGP Driving Value	DA	
AGP Fast Write	Disabled	
K7 CLK_CTL Select	Optimal	
OnChip USB	Enabled	
OnChip USB 2	Enabled	
USB Keyboard Support	Disabled	
OnChip Sound	Auto	
CPU to PCI Write Buffer	Enabled	
PCI Dynamic Bursting	Enabled	
PCI Master 0 WS Write	Enabled	
PCI Delay Transaction	Disabled	
PCI#2 Access #1 Retry	Enabled	
AGP Master 1 WS Write	Disabled	
AGP Master 1 WS Read	Disabled	

↑ ↓ → ← : Move Enter: Select +/-/PU/PD: Value F10: Save ESC: Exit F1: General Help
F5: Previous Values F6: Fail-Safe Defaults F7: Optimized Defaults

DRAM Timing by SPD This item allows you to select DRAM Timing by SPD or not.
SPD (Serial Presence Detect) you can find it located on your memory modules, BIOS reads information coded in SPD during system boot up resulting in an accurate memory operation.

DRAM Clock This item allows you to control the DRAM speed.
The choice: Host Clock, HCLK+33M.

SDRAM Cycle Length You can select CAS latency time in HCLKs of 2 or 3.
Time The system board designer should have set the values in this field, depending on the DRAM installed. Do not change the values in this field unless you change specifications of the installed DRAM or the installed CPU.

Bank Interleave The choice: Disabled, 2 Bank, 4 Bank.

DRAM Drive Strength Leave this item with Auto mode.
The choice: Auto, Manual.

DRAM Drive Value When "DRAM Drive Strength" is set to "Auto", this item will be unable to be selected. We don't recommend user to adjust this item.

Memory Hole In order to improve performance, certain space in memory is reserved for ISA cards. This memory must be mapped into the memory space below 16MB.
The choice: 15M-16M, Disabled.

PCI Master Pipeline Req Use default setting.

P2C/C2P Concurrency This item allows you to enable/disable the PCI to CPU, CPU to PCI concurrency.
The choice: Enabled, Disabled.

Fast R-W Turn Around This item controls the DRAM timing. It allows you to enable / disable the fast read / write turn around.
The choice: Enabled, Disabled.

- System BIOS Cacheable** Choose Enabled or Disabled. When enabled, the access to the system BIOS ROM addressed at F0000H - FFFFFH is cached.
- Video RAM Cacheable** Choose Enabled or Disabled. When enabled, the access to the VGA RAM addressed is cached.
- Frame Buffer size** This option allows you select memory size shared to on-chip graphics.
- AGP Aperture Size** Choose 4, 8, 16, 32, 64, 128 or 256 MB. Memory mapped and graphics data structures can reside in a Graphics Aperture. This area is like a linear buffer. BIOS will automatically report the starting address of this buffer to the O.S.
- AGP Driving Control** This item allows you to adjust the AGP driving force. Choose Manual to key in a AGP Driving Value in the next selection. This field is recommended to set in Auto for avoiding any error in your system.
The choice: Manual, Auto.
- AGP Driving Value** This item allows you to adjust the AGP driving force.
The choice: Min=0000 ~ Max=00FF.
- AGP Fast Write** This item will enable the AGP model into fast write mode.
- K7 CLK_CTL Select** Use this item to specify the clock control for ramp rate. Select default for a defaulted time value, and optimal for optimum time value which depends on different CPU ratio.
The choice: Enabled, Disabled.
- OnChip USB/USB2** This should be enabled if our system has a USB installed on the system board and you wish to use it. Even when so equipped, if you add a higher performance controller, you will need to disable this feature.
The choice: Enabled, Disabled.
- USB Keyboard Support** Enabled: Enable function when the USB keyboard is being used.
Disabled: When the AT keyboard is being used, choose disabled.

OnChip Sound Enabled: Turn on AC'97 codec chip controller.
Disabled: Turn off AC'97 codec chip controller or user can plug external add-on sound card.

CPU to PCI Write Buffer When this field is Enabled, writes from the CPU to the PCI bus are buffered, to compensate for the speed differences between the CPU and the PCI bus. When Disabled, the writes are not buffered and the CPU must wait until the write is complete before starting another write cycle.
The choice: Enabled, Disabled.

PCI Dynamic Bursting When Enabled, every write transaction goes to the write buffer. Burstable transactions then burst on the PCI bus and nonburstable transactions don't.
The choice: Enabled, Disabled.

PCI Master 0 WS Write When Enabled, writes to the PCI bus are executed with zero wait states.
The choice: Enabled, Disabled.

Memory Parity/ECC Check This item enabled to detect the memory parity and Error Checking & Correcting.
The choice: Enabled, Disabled.

PCI Delay Transaction Leave this field at default

PCI #2 Access #1 Retry Leave this field at default

AGP Master 1 ws write Leave this field at default

AGP Master 1 ws read Leave this field at default

3. Press <ESC> to return to the Main Menu when you finish setting up all items.

4-11 INTEGRATED PERIPHERALS

- INTEGRATED PERIPHERALS option allows you to get some informations inside your system when it is working.

Run the INTEGRATED PERIPHERALS as following:

1. Choose "INTEGRATED PERIPHERALS" from the Main Menu and a screen with a list of option will appear:

CMOS Setup Utility - Copyright (C) 1984-2001 Award Software
Integrated Peripherals

		Item Help
On-Chip IDE Channel0	Enabled	
On-Chip IDE Channel1	Enabled	Menu Level ▶
IDE Prefetch Mode	Enabled	
Primary Master PIO	Auto	
Primary Slave PIO	Auto	
Secondary Master PIO	Auto	
Secondary Slave PIO	Auto	
Primary Master UDMA	Auto	
Primary Slave UDMA	Auto	
Secondary Master UDMA	Auto	
Secondary Slave UDMA	Auto	
Init Display First	PCI Slot	
IDE HDD Block Mode	Enabled	
Onboard FDD Controller	Enabled	
Onboard Serial Port 1	Auto	
Onboard Serial Port 2	Auto	
UART 2 Mode	Standard	
× IR Function Duplex	Half	
× TX, RX inverting enable	No, Yes	
Onboard Parallel Port	378/IRQ7	
Onboard Parallel Mode	Normal	
× ECP Mode Use DMA	3	
× Parallel Port EPP Type	EPP1.9	
Onboard Legacy Audio	Enabled	
Sound Blaster	Disabled	
SB I/O Base Address	220H	
SB IRQ Select	IRQ 5	
SB DMA Select	DMA 1	
MPU-401	Disabled	
MPU-401 I/O Address	330-333H	
Game Port (200-207H)	Enabled	

↑↓←→:Move Enter:Select +/-/PU/PD:Value F10:Save ESC:Exit F1:General Help
F5:Previous Values F6:Fail-Safe Defaults F7:Optimized Defaults

2. Use one of the arrow keys to move between options and modify the selected options by using PgUp / PgDn / + / - keys. An explanation of the <F> keys follows:

<F1>: "Help" gives options available for each item.

<F5>: Get the previous values. These values are the values with which the user started in the current session.

<F6>: Load all options with the BIOS default values.

<F7>: Load all options with the Setup default values.

On-Chip IDE Channel0/1 The chipset contains a PCI IDE interface with support from two IDE channels. Select Enabled to activate the first and/or the second IDE interface. Select Disabled to deactivate an interface if you install a primary and/or second add-on IDE interface.
The choice: Enabled, Disabled.

IDE Prefetch Mode The onboard IDE drive interfaces supports IDE prefetching for faster drive accesses. If you install a primary and/or secondary add-in IDE interfaces, set this field to Disabled if the interface does not support prefetching.
The choice: Enabled, Disabled.

Primary Choose Auto or Mode 0~4. The BIOS will detect the HDD mode type automatically when you choose Auto.
Master / Slave PIO
Secondary You need to set to a lower mode than Auto when your hard disk becomes unstable.
Master / Slave PIO
The choice: Auto, Mode 0, Mode 1, Mode 2, Mode 3, Mode 4.

Primary Ultra DMA/66 implementation is possible only if your IDE hard drive supports it and the operating environment includes a DMA drive and your system software both support Ultra DMA/66, select Auto to enable BIOS support.
Master / Slave UDMA
Secondary
Master / Slave UDMA
The choice: Auto, Disabled.

- Init Display First** This option allows you to decide to activate PCI Slot or AGP first.
The choice: PCI Slot, AGP.
- IDE HDD Block Mode** Block mode is also called block transfer, multiple commands, or multiple sector read/write. If your IDE hard drive supports block mode (most new drives do), select Enabled for automatic detection of the optimal number of block read/write per sector the drive can support.
The choice: Enabled, Disabled.
- Onboard FDC Controller** Select Enabled if your system has a floppy drive controller (FDC) installed on the system board and you want to use it. If you install add-in FDC or the system has no floppy drive, select Disabled in this field.
The choice: Enabled, Disabled.
- Onboard Serial Port 1 / Port2** Select an address and corresponding interrupt for the first and second serial ports.
The choice: 3F8/IRQ4, 2E8/IRQ3, 3E8/IRQ4, 2F8/IRQ3, Disabled, Auto.
- UART 2 Mode** This item allows you to select which mode for the Onboard Serial Port 2.
The choice: Standard, HPSIR, ASKIR
- IR Function Duplex** This item allows you to select the IR half / full duplex function.
The choice: Half, Full.
- TX, RX inverting enable** This item allows you to enable the TX, RX inverting which depends on different H/W requirement. This field is not recommended to change its default setting for avoiding any error in your system.
The choice: "No, No", "No, Yes", "Yes, No", "Yes, Yes".
- Onboard Parallel Port** This item allows you to determine onboard parallel port controller I/O address setting.
The choice: 378H/IRQ7, 278H/IRQ5, 3BC/IRQ7, Disabled.

Parallel Port Mode Select an operating mode for the onboard parallel (printer) port. Select Normal, Compatible, or SPP unless you are certain your hardware and software both support one of the other available modes.
The choice: SPP, EPP, ECP, ECP + EPP.

ECP Mode Use DMA Select a DMA channel for the parallel port for use during ECP mode.
The choice: 3, 1.

Parallel Port EPP Type Select EPP port type 1.7 or 1.9
The choice: EPP1.7, 1.9.

Onboard Legacy Audio This field controls the onboard audio.

- Sound Blaster
- SB I/O Base Address
- SB IRQ Select
- SB DMA Select
- MPU-401
- MPU-401 I/O Address
- Game Port (200-207H)

3. Press <ESC> to return to the Main Menu when you finish setting up all items.

4-12 POWER MANAGEMENT SETUP

- POWER MANAGEMENT SETUP allows you to set the system's power saving functions.

Run the POWER MANAGEMENT SETUP as following:

1. Choose "POWER MANAGEMENT SETUP" from the Main Menu and a screen with a list of option will appear:

CMOS Setup Utility - Copyright (C) 1984-2001 Award Software
Power Management Setup

ACPI Function	Enabled	Item Help
▶ Power Management	Press Enter	Menu Level ▶
ACPI Suspend Type	S1(POS)	
PM Control by APM	Yes	
Video Off Option	Suspend -> Off	
Video Off Method	V/H SYNC+Blank	
MODEM Use IRQ	3	
Soft-Off by PWRBTN	Instant-Off	
▶ Wake Up Events	Press Enter	

↑↓→←:Move Enter:Select +/-/PU/PD:Value F10:Save ESC:Exit F1:General Help
F5:Previous Values F6:Fail-Safe Defaults F7:Optimized Defaults

2. Use one of the arrow keys to move between options and modify the selected options by using PgUp / PgDn / + / - keys. An explanation of the <F> keys follows:

<F1>: "Help" gives options available for each item.

<F5>: Get the previous values. These values are the values with which the user started in the current session.

<F6>: Load all options with the BIOS default values.

<F7>: Load all options with the Setup default values.

ACPI Function Enabled: Turn on ACPI function.
 Disabled: Turn off ACPI function.

- Press <Enter> on the Power Management item, then there is a list of it appears for you to choose further setting.

CMOS Setup Utility - Copyright (C) 1984-2001 Award Software
 Power Management

Power Management	User Define	Item Help
HDD Power Down	Disable	Menu Level ▶
Doze Mode	Disable	
Suspend Mode	Disable	

↑↓→←:Move Enter:Select +/-/PU/PD:Value F10:Save ESC:Exit F1:General Help
 F5:Previous Values F6:Fail-Safe Defaults F7:Optimized Defaults

Power Management This category allows you to select the type (or degree) of power saving and is directly related to the following modes:

HDD Power Down When enabled and after the set time of system inactivity, the hard disk drive will be powered down while all other devices remain active.

Doze Mode When enabled and after the set time of system inactivity, the CPU clock will run at slower speed while all other devices still operate at full speed.

Suspend Mode When enabled and after the set time of system inactivity, all devices except the CPU will be shut off.

ACPI Suspend Type This item will allow you to select the ACPI suspend type. You can select S3(STR) for suspending to DRAM or S1(POS) for power on suspend under Windows 98 ACPI mode.
The choice: S1(POS), S3(STR).

PM Control by APM When enabled, an Advanced Power Management device will be activated to enhance the Max. Power Saving mode and stop the CPU internal clock, If Advanced Power Management (APM) is installed on your system, selecting Yes gives better power savings. If the Max. Saving is not enabled, this will be present to No.

Video Off Option When enabled, this feature allows the VGA adapter to operate in a power saving mode.

Always On	Monitor will remain on during power saving modes.
Suspend --> Off	Monitor blanked when the systems enters the Suspend mode.
Susp, Stby --> Off	Monitor blanked when the system enters either Suspend or Standby modes.

Video Off Method This determines the manner in which the monitor is blanked.

V/H SYNC + Blank	This selection will cause the system to turn off the vertical and horizontal synchronization ports and write blanks to the video buffer.
Blank Screen	This option only writes blanks to the video buffer.
DPMS	Select this option if your monitor supports the Display Power Management Signaling (DPMS) standard of the Video Electronics Standards to select video power management values.

MODEM Use IRQ This determines the IRQ in which the MODEM can use.
The choice: 3, 4, 5, 7, 9, 10, 11, NA.

Soft-Off by PWRBTN Instant-Off: Turn off the system power at once after pushing the power button.
 Delay 4 Sec: Turn off the system power 4 seconds after pushing the power button. (to meet PC97/98 spec)

- Press <Enter> on the Wake Up Events item, then there is a list of it appears for you to choose further setting.

CMOS Setup Utility - Copyright (C) 1984-2001 Award Software
 Wake Up Events

VGA	OFF	Item Help
LPT & COM	LPT/COM	Menu Level ▶
HDD & FDD	ON	
PCI Master	OFF	
Wake Up On LAN/Ring	Disabled	
RTC Alarm Resume	Disabled	
× Date (of Month)	0	
× Resume Time (hh:mm:ss)	0 0 0	
Primary INTR	ON	
IRQ Activity Monitoring	Press Enter	

↑↓→←:Move Enter:Select +/-/PU/PD:Value F10:Save ESC:Exit F1:General Help
 F5:Previous Values F6:Fail-Safe Defaults F7:Optimized Defaults

VGA When Enabled, you can set the VGA awakens the system

LPT & COM When On of LPT & COM, any activity from one of the listed system peripheral devices or IRQs wakes up the system.

HDD & FDD When On of HDD & FDD, any activity from one of the listed system peripheral devices wakes up the system.

PCI Master When On of PCI Master, any activity from one of the listed system peripheral devices wakes up the system.

Wake Up On LAN/Ring An input signal on the serial Ring Indicator (RI) line (in other words, an incoming call on the modem) awakens the system from a soft off state.
The choice: Enabled, Disabled.

RTC Alarm Resume When Enabled, you can set the data and time at the which the RTC (Real Time Clock) alarm awakens the system from suspend mode.
The choice: Disabled (default), Enabled.

Date (of Month) Set a certain date when RTC Alarm Resume option is Enabled to awaken the system. This option is concurrent with Resume Time option.

Resume Time (hh:mm:ss) Set a certain time when RTC Alarm Resume option is Enabled to awaken the system. This option is concurrent with Date option.

Primary INTR Leave this field at default

IRQS Activity Monitoring The following is a list of IRQ's (Interrupt ReQuests), which can be exempted much as the COM ports and LPT ports above can. When an I/O device wants to gain the attention of the operating system, it signals this by causing an IRQ to occur. When the operating system is ready to respond to the request, it interrupts itself and performs the service. When set On, activity will neither prevent the system from going into a power management mode nor awaken it.

CMOS Setup Utility - Copyright (C) 1984-2001 Award Software
 IRQ Activity Monitoring

		Item Help
IRQ 3 (COM2)	Enabled	Menu Level ▶
IRQ 4 (COM1)	Enabled	
IRQ 5 (LPT2)	Enabled	
IRQ 6 (Floppy Disk)	Enabled	
IRQ 7 (LPT1)	Enabled	
IRQ 8 (RTC Alarm)	Disabled	
IRQ 9 (IRQ2 Redir)	Disabled	
IRQ 10 (Reserved)	Disabled	
IRQ 11 (Reserved)	Disabled	
IRQ 12 (PS/2 Mouse)	Enabled	
IRQ 13 (Coprocessor)	Enabled	
IRQ 14 (Hard Disk)	Enabled	
IRQ 15 (Reserved)	Disabled	

↑ ↓ → ←: Move Enter: Select +/-/PU/PD: Value F10: Save ESC: Exit F1: General Help
 F5: Previous Values F6: Fail-Safe Defaults F7: Optimized Defaults

- Press <ESC> to return to the Main Menu when you finish setting up all items.

4-13 PNP / PCI CONFIGURATION

- PNP/PCI CONFIGURATION allows you to set the system's power saving functions.

Run the PNP/PCI CONFIGURATION as following:

1. Choose "PNP/PCI CONFIGURATION" from the Main Menu and a screen with a list of option will appear:

CMOS Setup Utility - Copyright (C) 1984-2001 Award Software
PnP/PCI Configurations

PNP OS Installed	No	Item Help
Reset Configuration Data	Disabled	Menu Level ▶
Resources Controlled By	Auto(ESCD)	
×IRQ Resources	Press Enter	
×DMA Resources	Press Enter	
PCI/VGA Palette Snoop	Disabled	
Assign IRQ For VGA	Enabled	
Assign IRQ For USB	Enabled	

↑↓→←:Move Enter:Select +/-/PU/PD:Value F10:Save ESC:Exit F1:General Help
F5:Previous Values F6:Fail-Safe Defaults F7:Optimized Defaults

2. Use one of the arrow keys to move between options and modify the selected options by using PgUp / PgDn / + / - keys. An explanation of the <F> keys follows:

<F1>: "Help" gives options available for each item.

<F5>: Get the previous values. These values are the values with which the user started in the current session.

<F6>: Load all options with the BIOS default values.

<F7>: Load all options with the Setup default values.

PNP OS Installed Yes: OS supports Plug and Play function.
 No: OS doesn't support Plug and Play function.

NOTE: BIOS will automatically disable all PNP resources except the boot device card when you select Yes on Non-PNP operating system.

Reset Configuration Data Choose Enabled or Disabled. Disabled **retains** PNP configuration data in BIOS and Enabled **resets** the PNP configuration data in BIOS.

Resource Controlled By Choose Manual or Auto. The BIOS checks the IRQ / DMA channel number on the ISA and PCI card manually if you choose Manual and the IRQ / DMA channel number will be checked automatically if you choose Auto.

IRQ Resources Press Enter. Please refer to the below list.

CMOS Setup Utility - Copyright (C) 1984-2001 Award Software
 IRQ Resources

IRQ-3 assigned to	PCI/ISA PnP	Item Help
IRQ-4 assigned to	PCI/ISA PnP	Menu Level ▶
IRQ-5 assigned to	PCI/ISA PnP	
IRQ-7 assigned to	PCI/ISA PnP	
IRQ-9 assigned to	PCI/ISA PnP	
IRQ-10 assigned to	PCI/ISA PnP	
IRQ-11 assigned to	PCI/ISA PnP	
IRQ-12 assigned to	PCI/ISA PnP	
IRQ-14 assigned to	PCI/ISA PnP	
IRQ-15 assigned to	PCI/ISA PnP	

↑↓←→:Move Enter:Select +/-/PU/PD:Value F10:Save ESC:Exit F1:General Help
 F5:Previous Values F6:Fail-Safe Defaults F7:Optimized Defaults

DMA Resources Press Enter. Please refer to the below list.

CMOS Setup Utility - Copyright (C) 1984-2001 Award Software
DMA Resources

DMA-0 assigned to	PCI/ISA PnP	Item Help
DMA-1 assigned to	PCI/ISA PnP	Menu Level ▶
DMA-3 assigned to	PCI/ISA PnP	
DMA-5 assigned to	PCI/ISA PnP	
DMA-6 assigned to	PCI/ISA PnP	
DMA-7 assigned to	PCI/ISA PnP	

↑↓→←:Move Enter:Select +/-/PU/PD:Value F10:Save ESC:Exit F1:General Help
F5:Previous Values F6:Fail-Safe Defaults F7:Optimized Defaults

PCI/VGA Palette Snoop Leave this field at Disabled.
The choice: Enabled, Disabled.

Assign IRQ for VGA Enabled: Add one IRQ to VGA controller.
Disabled: Remove IRQ from USB controller. The system will have extra IRQ for other devices but the VGA controller will still not be disabled. (only IRQ was removed)

Assign IRQ for USB Enabled: Add one IRQ to USB controller.
Disabled: Remove IRQ from USB controller. The system will have extra IRQ for other devices but the USB controller will still not be disabled. (only IRQ was removed)

3. Press <ESC> to return to the Main Menu when you finish setting up all items.

4-14 SMARTDOC ANTI-BURN SHIELD

- This section helps you to get more information about your system including CPU temperature, FAN speed and voltage. It is recommended that you contact with your motherboard supplier to get proper value about your setting of the CPU temperature.

Run the “SMARTDOC ANTI-BURN SHIELD” as following:

1. Choose “SMARTDOC ANTI-BURN SHIELD” from the Main Menu and a screen with a list of option will appear:

CMOS Setup Utility - Copyright (C) 1984-2001 Award Software
SmartDoc Anti-Burn Shield

CPU Warning Temperature	Disabled	Item Help
Shutdown For Temperature	Disabled	Menu Level ▶
CPUFan Warning Speed	Disabled	
Shutdown For CPUFan	Disabled	
Current CPU Temp.	36°C/96°F	
Current System Temp.	°C/32°F	
Current CPUFAN1 Speed	5120 RPM	
Current CPUFAN2 Speed	0 RPM	
Vcore	1.53V	
VDD	3.34V	
3.3V	3.28V	
5V	5.00V	
12V	11.76V	

↑↓→←:Move Enter:Select +/-/PU/PD:Value F10:Save ESC:Exit F1:General Help
F5:Previous Values F6:Fail-Safe Defaults F7:Optimized Defaults

2. Use one of the arrow keys to move between options and modify the selected options by using PgUp / PgDn / + / - keys.

CPU Warning Temp. User can select CPU warning temperature in this field, when CPU Temperature is higher than value you selected in this field, the BIOS will send out sequence of beeps sound or send out a message “your CPU temperature **is too high**” to warning you.

Shutdown For Temp. This feature preventing your CPU damaged by over heat, if the CPU’s temperature higher than “CPU warning temperature” that you selected in this field, the BIOS will shut down your system within 3 seconds.

CPUFan Warning Speed This feature preventing CPU cooling stops function or not functions normally, when CPU cooling fan speed lower than value you selected in this field, the BIOS will send out sequence of beeps sound or send out a message “**Your CPU FAN speed is too slow**” to warning you.

Shutdown For CPUFan This feature also preventing your CPU damaged by over heat, but the different between features “**Shutdown For Temperature**” and “**Shutdown For CPUFan**” is that BIOS detects CPU cooling fan speed not CPU Temperature in this field, when CPU FAN speed lower than the value that you selected in this field, the BIOS will shutdown your system within 3 seconds.

Warning!!! Do not enable feature “Shutdown For CPUFan” without CPU cooling fan connecting to onboard fan connector **FAN1**; otherwise, your system will not power on.

Current CPU Temp. Shows current CPU temperature.

Current System Temp. Shows current system temperature.

Current CPUFAN1 Speed Shows current CPUFAN1 speed. The fan must provide rotary pulse. (Normally these types of fan have a three-wire connector)

Current CPUFAN2 Shows current CPUFAN2 speed. The fan must provide rotary pulse. (Normally these types of fan have a three-wire connector)
Speed

Vcore/VDD/3.3V/5V/12V Show power supply actual voltage value.

- Press <ESC> to return to the Main Menu when you finish setting up all items.

4-15 FREQUENCY/VOLTAGE CONTROL

CMOS Setup Utility - Copyright (C) 1984-2001 Award Software
Frequency Control

Auto Detect DIMM/PCI Clk	Enabled	Item Help
Spread Spectrum Modulated	Disabled	Menu Level ▶
CPU Host Clock (CPU/PCI)	Default	
CPU Voltage Regulator	Default	

↑↓←→:Move Enter:Select +/-/PU/PD:Value F10:Save ESC:Exit F1:General Help
F5:Previous Values F6:Fail-Safe Defaults F7:Optimized Defaults

Redstorm Overclocking Tech Please press <Enter> to start *RED STORM OVERCLOCKING TECH*, this option helps user an easy way to overclocking, it will increase CPU external clock automatically, when CPU external clock increasing to unacceptable value, BIOS will restart your system, then running at acceptable CPU external clock.

Auto Detect DIMM/PCI CLK This item allows you to enable/disable detect DIMM/PCI Clock.
The choice: Enabled, Disabled.

Spread Spectrum Modulated This item allows you to enable/disable the spread spectrum modulate.
The choice: Enabled, Disabled.

CPU Host Clock (CPU/PCI) This item allows you to select CPU/PCI frequency.
The choice: Default, 100/33MHz, 103/34MHz, 105/35MHz, 112/37MHz, 115/38MHz, 120/40MHz, 124/41MHz.

CPU Voltage Regulator This item allows user to adjust the CPU Vcore voltage. The instant damage of CPU is due to the wrong Vcore voltage setting, so that we recommend that user should leave this item with Default setting unless you know how to adjust it.

- Press <ESC> to return to the Main Menu when you finish setting up all items.

4-16 LOAD OPTIMIZED DEFAULTS

- When you press <Enter> on this item you get a confirmation dialog box with a message similar to:

“ Load Optimized Defaults (Y / N) ? N ”

Pressing “Y” loads the BIOS default values that are factory settings for optimal performance system operations.

4-17 SET SUPERVISOR / USER PASSWORD

- These two options allow you to set your system passwords. Normally, the supervisor has a higher ability to change the CMOS setup option than the user. The way to set up the passwords for both Supervisor and User are as follows:

1. Choose "Change Password" in the Main Menu and press <Enter>. The following message appears:

"Enter Password : "

2. The first time you run this option, enter your password up to 8 characters and press <Enter>. The screen does not display the enter characters.
3. After you enter the password, the following message appears prompting you to confirm the password:

"Confirm Password : "

4. Enter the same password "exactly" as you just typed again to confirm the password and press <Enter>.
5. Move the cursor to Save & Exit Setup to save the password.
6. If you need to delete the password out entered before, choose the Supervisor Password and press <Enter>. It will delete the password that you had before.
7. Move the cursor to Save & Exit Setup to save the option you did, otherwise the old password will still be there the next time you turn your system on.
8. Press <Enter> to exit to the Main Menu.

NOTE: *If you forget or lose the password, the only way to access the system is to clear the CMOS RAM. All setup informations will be lost and you need to run the BIOS setup program again.*

4-18 SAVE & EXIT SETUP

- SAVE & EXIT SETUP allows you to save all modifications you have specified into the CMOS memory. Highlight this option on the Main Menu and the following message appears:

`"SAVE to CMOS and EXIT (Y/N) ? Y "`

Press <Enter> key to save the configuration changes.

4-19 EXIT WITHOUT SAVING

- EXIT WITHOUT SAVING option allows you to exit the Setup Utility without saving the modifications that you have specified. Highlight this option on the Main Menu and the following message appears:

`"Quit Without Saving (Y/N) ? N "`

You may change the prompt to "Y" and press <Enter> key to leave this option .



