

Pentium Pro

**82440 FX PCI Mainboard
User's Guide &
Technical Reference
*6FA2/A5***



SOYOTM

About This Guide

This User's Guide is for assisting system manufacturers and end users in setting up and installing the mainboard. Information in this guide has been carefully checked for reliability; however, no guarantee is given as to the correctness of the contents. The information in this document is subject to change without notice.

Copyright Notice

Copyright 1997, Soyo Computer Inc. All rights reserved. This manual is copyrighted by Soyo Computer Inc. You may not reproduce, transmit, transcribe, store in a retrieval system, or translate into any language, in any form or by any means, electronic, mechanical, magnetic, optical, chemical, manual, or otherwise, any part of this publication without express written permission of Soyo Computer Inc.

Trademarks

Soyo is a registered trademark of Soyo Computer Inc. All trademarks are the property of their owners.

Disclaimer

Soyo Computer Inc. makes no representations or warranties regarding the contents of this manual. We reserve the right to revise the manual or make changes in the specifications of the product described within it at any time without notice and without obligation to notify any person of such revision or change. The information contained in this manual is provided for general use by our customers. Our customers should be aware that the personal computer field is the subject of many patents. Our customers should ensure that they take appropriate action so that their use of our products does not infringe upon any patents. It is the policy of Soyo Computer Inc. to respect the valid patent rights of third parties and not to infringe upon or assist others to infringe upon such rights.

Restricted Rights Legend

Use, duplication, or disclosure by the Government is subject to restrictions set forth in subparagraph (c)(1)(ii) of the Rights in Technical Data and Computer Software clause at 252.277-7013.

Product Rights

Product mentioned in this manual are mentioned for identification purpose only. Product names appearing in this manual may or may not be registered trademarks or copyrights of their respective companies.

If you need any further information, please come to our home page on internet. The address is "<http://www.soyo.com.tw>".

Edition: June 1996

Version 1.0

6FA2/A5 SERIAL

Table of Contents

Chapter 1: Introduction	1
Key Features	1
Unpacking the Mainboard	2
Electrostatic Discharge Precautions	2
Mainboard Layout w/ Default Settings	3
Chapter 2: Hardware Setup	5
Jumpers	5
Factory Set Jumpers	5
JP3: Display Type	5
J23: Sleep Switch Connector Enable/Disable	5
JP5: CMOS Clear Jumper	6
JP13: Bus Fraction Core/Bus Ratio Select	6
JP35: AT/ATX Power Supply Select	7
JPS2: PS/2 Mouse Function Jumper	7
JP16: Internal Sleep Switch Connector (Reserved)	7
VRM (Voltage Regulator Module) Socket	7
CPU Type Configuration	8
Memory Configuration	9
DIMM Voltage Setting	10
Multi I/O Port Addresses	10
Connectors	11
ATX PW — ATX Power Supply Connectors	11
AT PW – AT Power Supply Connectors	11
CN1 – PS/2 Keyboard Connector	12
CN2 – PS/2 Mouse Connector	12
CN3 – IR Connector	12
J17 – Keylock & Power LED Connector	12
J18 – Speaker Connector	12
J19 – Hardware Reset Control	12
IDE1/IDE2 – On-board Primary/Secondary IDE HDD Connectors	12
COM1/COM2 Connectors	12
J24 – HDD LED Connectors	13
FDC Connector	13
PRT1 – Parallel Port Connector	13
CN4 – Universal Serial Bus Connector (Optional)	13
JP29 – ATX Power Supply On/Off Switch Connector (Reserved)	13

Chapter 3: BIOS Setup	14
Standard CMOS Setup	15
BIOS Features Setup	16
Chipset Features Setup	18
Power Management Setup	21
PNP/PCI Configuration Setup	23
Load Setup Defaults	24
Load BIOS Defaults	25
Integrated Peripherals	25
Supervisor Password	28
User Password	29
IDE HDD Auto Detection	30
Chapter 4: Drivers Installation Guide	31
MS-DOS/WINDOW/WFW	31
WINDOWS NT3.5	31
WINDOWS 95	32
NOVELL 3.X&4.X	32
SCO UNIX	32
SCO UNIX 5.0	33
OS/2 2.0 and WARP 3.X	34

1 Introduction

The 82440 FX PCI mainboard is a high-performance ATX architecture system board that supports P6 family CPUs. This mainboard is fully compatible with industry standards, and adds many technical enhancements.

Key Features

- Processor supports:
 - P6 CPU up to 66 MHz bus frequency (150 ~ 200 MHz)
 - **auto detection of CPU voltage**
 - **SOCKET 8 and VRM support**
- DRAM controller:
 - **supports Fast-Page Mode, EDO, Burst EDO, SMM (both symmetrical and asymmetrical addressing), and Fast-Page Mode/EDO Unbuffered DIMM**
 - supports auto detection of memory type
 - **supports ECC or Parity configuration**
 - has onboard memory configurations from 8MB to 768MB
 - supports “Table-Free” DRAM configuration in any SIMM bank
- BUS controller:
 - complies with the PCI specifications v2.1
 - four 32-bit PCI slots (Masters), four ISA slots, and 4-layer PCB
 - **supports Universal Serial Bus—USB (Optional)**
- Peripheral controller:
 - System BIOS built-in NCR306 SCSI Card BIOS and “Plug and Play” function
 - onboard built-in PCI Master IDE controller and floppy controller
 - onboard supports for two high speed UARTS (w/i 16550 FIFO) and Multimode parallel port for Standard, Enhanced (EPP) and high speed (ECP) modes, PS/2 mouse function
 - onboard supports FLASH Memory for easy upgrade BIOS
 - **onboard supports IR function.**

Unpacking the Mainboard

The mainboard package contains:

- The 82440FX Mainboard
- This User's Guide

Note: Do not unpack the mainboard until you are ready to install it.

Follow the precautions below while unpacking the mainboard.

1. Before handling the mainboard, ground yourself by grasping an unpainted portion of the system's metal chassis.
2. Remove the mainboard from its anti-static packaging and place it on a grounded surface, component side up.
3. Check the mainboard for damage. If any chip appears loose, press carefully to seat it firmly in its socket.

Do not apply power if the mainboard appears damaged. If there is damage to the board contact your dealer immediately.

Electrostatic Discharge Precautions

Make sure you ground yourself before handling the mainboard or other system components. Electrostatic discharge can easily damage the components. Note that you must take special precaution when handling the mainboard in dry or air-conditioned environments.

Take these precautions to protect your equipment from electrostatic discharge:

- Do not remove the anti-static packaging until you are ready to install the mainboard and other system components.
- Ground yourself before removing any system component from its protective anti-static packaging. To ground yourself grasp the expansion slot covers or other unpainted portions of the computer chassis.
- Frequently ground yourself while working, or use a grounding strap.
- Handle the mainboard by the edges and avoid touching its components.

Mainboard Layout w/ Default Settings

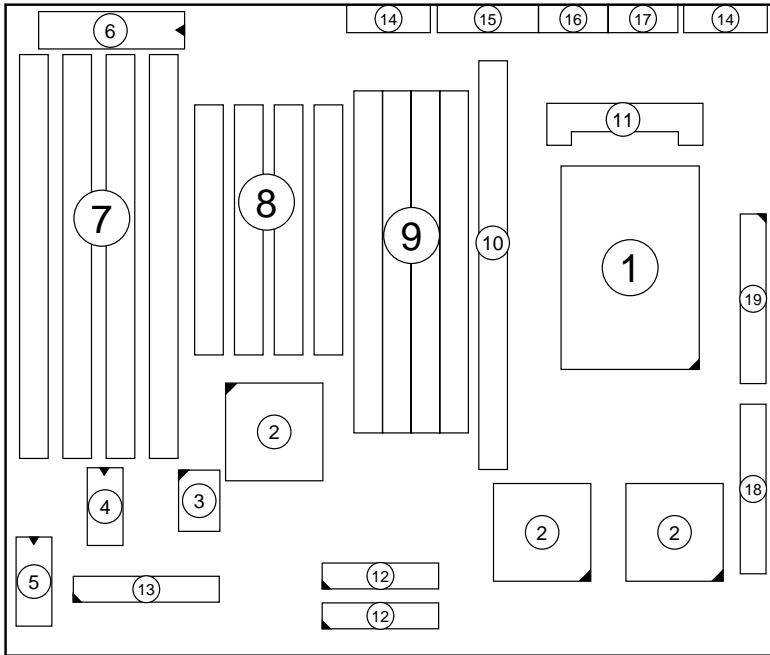

Figure 1-1. Mainboard Layout

- | | | | |
|-----|-------------------------|-----|-------------------------|
| 1. | ZIF SOCKET 8 for P6 CPU | 11. | VRM SOCKET |
| 2. | 82440FX Chipset | 12. | IDE1/IDE2 Connector |
| 3. | Super I/O Chip | 13. | Floppy Connector |
| 4. | PnP FLASH BIOS | 14. | COM1/COM2 Connector |
| 5. | RTC | 15. | Parallel Port Connector |
| 6. | Keyboard BIOS | 16. | PS/2 Mouse Connector |
| 7. | ISA Slot | 17. | PS/2 Keyboard Connector |
| 8. | PCI Slot | 18. | AT Power Connector |
| 9. | SIMM Memory Bank | 19. | ATX Power Connector |
| 10. | DIMM Memory Slot | | |

Default settings are as follows: Pentium Pro 166MHz CPU, On-board PCI Bus IDE Enabled, FDC Enabled, 2 high speed UARTS Enabled (w/ 16550 FIFO), 1 EPP/ECP port (ECP + EPP mode), 3.3V DIMM Memory, and ATX Power Supply.

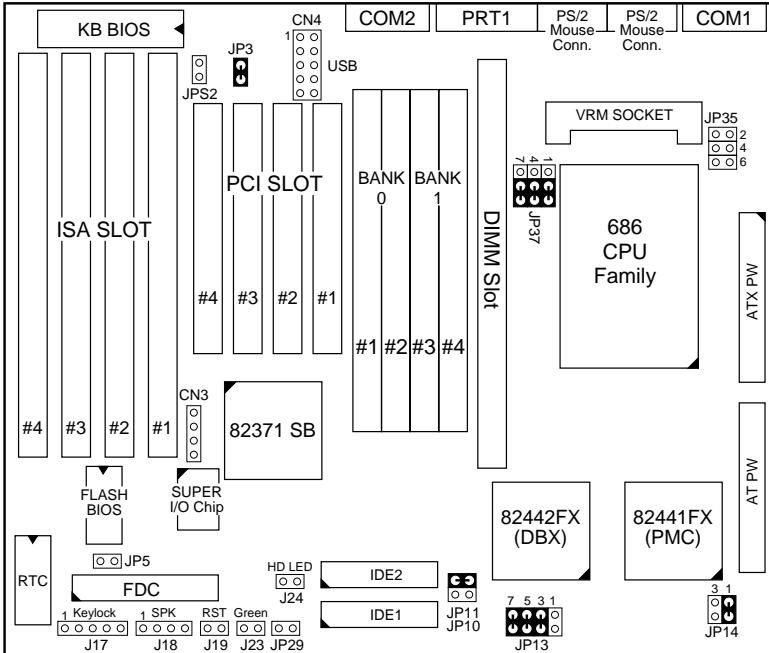

Figure 1-2. Mainboard Default Setting

Important: *Make sure the system is well ventilated to prevent overheating and ensure system stability.*

2 Hardware Setup

This chapter explains how to configure the mainboard's hardware. After you install the mainboard, you can set jumpers, install memory on the mainboard, and make case connections. Refer to this chapter whenever you upgrade or reconfigure your system.

CAUTION: *Turn off power to the mainboard, system chassis, and peripheral devices before performing any work on the mainboard or system.*

Jumpers



Factory Set Jumpers

The following jumpers are set at the factory as below.

Jumpers	Factory settings
JP15	Factory fixed at 2–3
EMI GND	Factory setting at 1–2, 3–4 short

JP3: Display Type

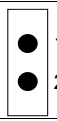
Set JP3 to configure the mainboard for use with either a color or monochrome monitor.



Monitor Type	JP3
Monochrome	
EGA/VGA (default)	

J23: Sleep Switch Connector Enable/Disable

Toggle this jumper to force the system into power saving (Green) mode. Any hardware IRQ signal makes the system wakeups.

JP5: CMOS Clear Jumper

Clear the CMOS memory by momentarily shorting this jumper; then open the jumper to retain new settings.

CMOS Setting	JP5
Retain CMOS data (default)	 1 2
Clear CMOS data	 1 2

JP13: Bus Fraction Core/Bus Ratio Select

Set this jumper according to your CPU clock.

Note: For P6 **X** / **Y** MHz, **X** stands for CPU core clock, **Y** stands for bus clock.

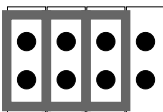
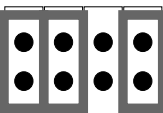
Ratio	P6 Family	JP13
5/2 (default)	P6 — 150, 166 MHz	<p>7 5 3 1</p> 
3/1	P6 — 180, 200 MHz	<p>7 5 3 1</p> 

JP35: AT/ATX Power Supply Select

Set this jumper according to the power supply that you use.

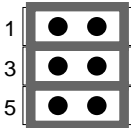
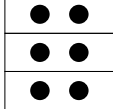
Power Supply Type	JP35
AT	
ATX (default)	

JPS2: PS/2 Mouse Function Jumper

Set PS/2 mouse function enabled or disabled.

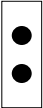
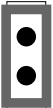
PS/2 Mouse Function	JPS2
Disabled (default)	
Enabled	

Note: The IRQ12 is dedicated to PS/2 mouse when choose enabled of PS/2 Mouse Function.

JP16: Internal Sleep Switch Connector (Reserved)

This switch is reserved for programming use, especially in S/W programming.

VRM (Voltage Regulator Module) Socket

VRM socket is dedicated for different voltages of CPU. It changes the proper voltage automatically to meet the CPU's specification.

CPU Type Configuration

Set the mainboard's CPU jumpers JP10, JP11, JP13, and JP14 according to CPU type as described below.

Pentium Pro – 150/166 CPU Settings (2.5 x clock)

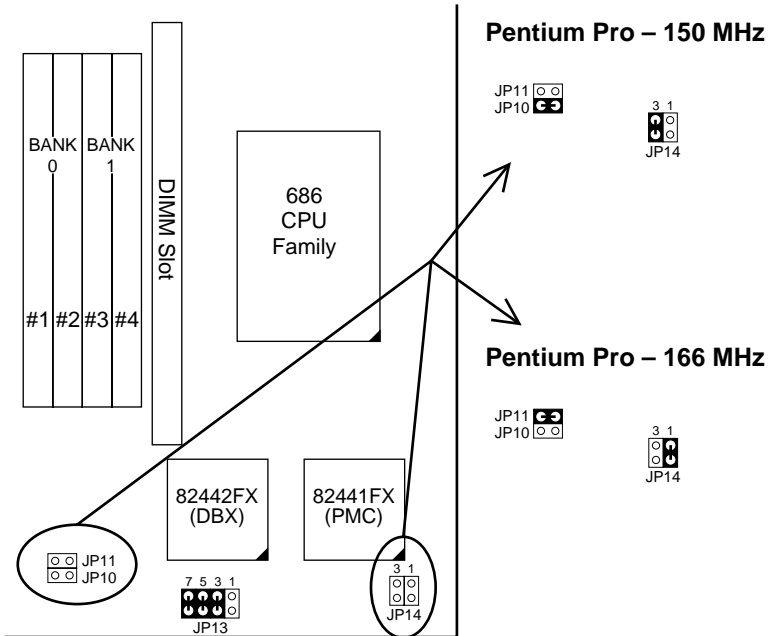

Figure 2-1-1 CPU Jumper Settings

Note: You must equip the CPU with a fan and heat sink for system stability.

Pentium Pro – 180/200 CPU Settings (3.0 x clock)

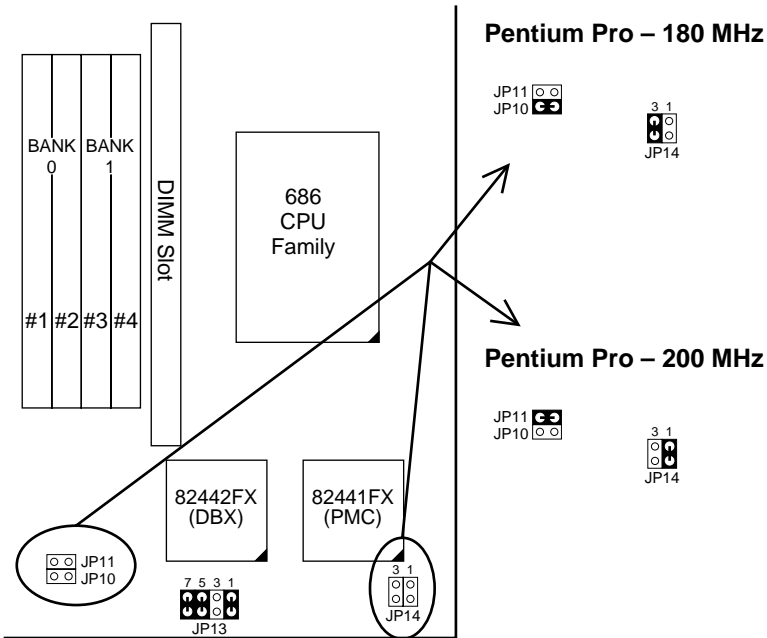

Figure 2–1–2. CPU Jumper Settings

Note: You must equip the CPU with a fan and heat sink for system stability.

Memory Configuration

The mainboard supports two banks of **72-pin Fast Page Mode/EDO/Burst EDO SIMM (with or without parity) and Fast Page Mode/EDO Unbuffered DIMM**. The mainboard requires SIMM of at least 70ns access time.

Single-side SIMM	Double-side SIMM
16MB = 4MB x 36(32)	8MB = 2MB x 36(32)
64MB = 16MB x 36(32)	32MB = 8MB x 36(32)

The mainboard supports **from 8 to 768 Mbytes** with no other restrictions on memory configurations. You can install DRAM in any combination without having to rely on a memory configuration table. Memory configuration is thus “**Table-Free**” in any bank.

Note: You must install two strips of SIMM modules to complete a bank.

DIMM Voltage Setting

You must check the voltage of your DIMM before you install it. See JP37 to configure the proper voltage for DIMM.

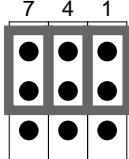
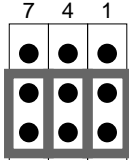
Type of DIMM	JP37
5V DIMM	 <p>Diagram showing the JP37 jumper settings for 5V DIMM. The jumper is placed over pins 7, 4, and 1.</p>
3.3V DIMM (default)	 <p>Diagram showing the JP37 jumper settings for 3.3V DIMM (default). The jumper is placed over pins 7, 4, and 1.</p>

Multi I/O Port Addresses

Default settings for multi-I/O port addresses are shown in the table below.

Port	I/O Address	IRQ	Status
LPT1*	378H	7	ECP + EPP
COM1	3F8H	4	
COM2	2F8H	3	

* If default I/O port addresses conflict with other I/O cards (e.g. sound cards or I/O cards), you must adjust one of the I/O addresses to avoid address conflict. (You can adjust these I/O addresses from the BIOS.)

Note: Some sound cards have a default IRQ setting for IRQ7, which may conflict with printing functions. If this occurs do not use sound card functions at the same time you print.

Connectors

Attach the mainboard to case devices, or an external battery, via connectors on the mainboard. Refer to Figure 1-1 for connector locations and connector pin positions.

ATX PW — ATX Power Supply Connectors

The motherboard provides an ATX power supply connector. It is a twenty-pin male header connector. Plug the connector from the power directly onto the board connector while making sure the pin1 is in its position. **You can only use either AT or ATX power.**

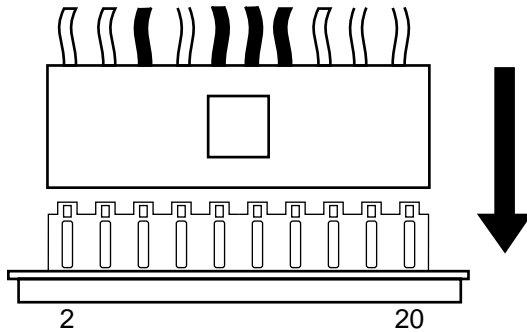

AT PW – AT Power Supply Connectors

The mainboard requires a power supply with at least 200 watts and a “power good” signal. AT PW has two six-pin male header connectors. Plug the dual connectors from the power directly onto the board connector while making sure the black leads are in the center.

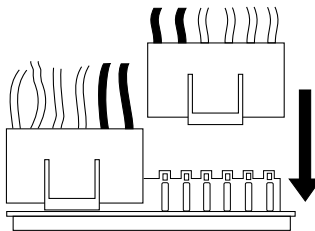

CN1 – PS/2 Keyboard Connector

A six-pin female PS/2 keyboard connector is located at the rear of the board. Plug the keyboard jack into this connector.

CN2 – PS/2 Mouse Connector

A six-pin female PS/2 mouse connector is located at the rear of the board. Plug the mouse jack into this connector and do remember to plug the jumper into “JPS2”.

CN3 – IR Connector

A four-pin wafer connector is for connecting to the IR device. Use the device that has the ASKIR or HPSIR specification and choose ASKIR/HPSIR from the BIOS setup.

J17 – Keylock & Power LED Connector

J17 is a connector for a lock that may be installed on the system case for enabling or disabling the keyboard. J17 also attaches to the case’s Power LED. (Pin 1, 3 for power LED, pin 4, 5 for keylock.)

J18 – Speaker Connector

Attach the system speaker to connector J18.

J19 – Hardware Reset Control

Attach the Reset switch to J19. Closing the Reset switch restarts the system.

IDE1/IDE2 – On-board Primary/Secondary IDE HDD Connectors

Attach on-board hard disk drives to these connectors.

COM1/COM2 Connectors

Connect COM1/COM2 devices to these connectors.

J24 – HDD LED Connectors

Attach on-board hard disk drive LEDs to this connector. The LED lights when an HDD is active.

FDC Connector

Attach floppy cable to this connector.

PRT1 – Parallel Port Connector

Attach parallel port cable to this connector.

CN4 – Universal Serial Bus Connector (Optional)

Attach USB cable to these connectors for external USB device.

JP29 – ATX Power Supply On/Off Switch Connector (Reserved)

This jumper is reserved for when your ATX power supply doesn't have the On/Off switch. Attach a two-pin switch to this connector for turning the ATX power supply on/off.

3 BIOS Setup

The mainboard's BIOS setup program is the ROM PCI/ISA BIOS from Award Software Inc. Enter the Award BIOS program's Main Menu as follows:

1. Turn on or reboot the system. After a series of diagnostic checks, you are asked to press DEL to enter Setup.
2. Press the key to enter the Award BIOS program and the main screen appears:

ROM PCI/ISA BIOS
CMOS SETUP UTILITY
AWARD SOFTWARE, INC.

STANDARD CMOS SETUP	INTEGRATED PERIPHERALS
BIOS FEATURES SETUP	SUPERVISOR PASSWORD
CHIPSET FEATURES SETUP	USER PASSWORD
POWER MANAGEMENT SETUP	IDE HDD AUTO DETECTION
PNP/PCI CONFIGURATION	SAVE & EXIT SETUP
LOAD SETUP DEFAULTS	EXIT WITHOUT SAVING
Esc : Quit	↑ ↓ → ← : Select Item
F10 : Save & Exit Setup	(Shift) F2 : Change Color
Time, Date, Hard Disk Type...	

3. Choose an option and press <Enter>. Modify the system parameters to reflect the options installed in the system. (See the following sections.)
4. Press <ESC> at anytime to return to the Main Menu.
5. In the Main Menu, choose "SAVE AND EXIT SETUP" to save your changes and reboot the system. Choosing "EXIT WITHOUT SAVING" ignores your changes and exits the program.

The Main Menu options of the Award BIOS are described in the sections that follow.

Standard CMOS Setup

Run the Standard CMOS Setup as follows.

1. Choose "STANDARD CMOS SETUP" from the Main Menu. A screen appears.

ROM PCI/ISA BIOS
STANDARD CMOS SETUP
AWARD SOFTWARE, INC.

Date (mm:dd:yy) : Fri, Feb 1 1995								
Time (hh:mm:ss) : 7 : 30 : 33								
HARD DISKS	TYPE	SIZE	CYLS	HEAD	PRECOMP	LANDZ	SECTOR	MODE
Primary Master	: None	0	0	0	0	0	0	----
Primary Slave	: None	0	0	0	0	0	0	----
Secondary Master	: None	0	0	0	0	0	0	----
Secondary Slave	: None	0	0	0	0	0	0	----
Drive A : 1.44M, 3.5 in.								
Drive B : None								
Video : EGA/VGA								
Halt On : All Errors								
		Base Memory: 640K						
		Extended Memory: 3328K						
		Other Memory: 128K						
		Total Memory: 4096K						
Esc : Quit		↑ ↓ → ← : Select Item		PU/PD/+/- : Modify				
F11 : Help		(Shift) F2 : Change Color		F3 : Toggle Calendar				

2. Use arrow keys to move between items and select values. Modify selected fields using PgUp/PgDn/+/- keys. Some fields let you enter values directly.

Date (mm/dd/yy) Type the current date.

Time (hh:mm:ss) Type the current time.

Primary (Secondary) Master & Slave Choose from the standard hard disk types 1 to 46. Type 47 is user definable. If a hard disk is not installed choose "Not installed." (default)

Drive A & B Choose 360KB , 5 1/4 in.,
1.2MB , 5 1/4 in.,
720KB , 3 1/2 in.,
1.4M , 3 1/2 in.(default),
2.88 MB, 3 1/2 in. or
Not installed

Video Choose Monochrome,
Color 40x25,
VGA/EGA (default),
Color 80x25

3. When you finish, press the <ESC> key to return to the Main Menu.

BIOS Features Setup

Run the BIOS Features Setup as follows.

1. Choose “BIOS FEATURES SETUP” from the Main Menu and a screen with a list of items appears. (**The screen below shows the BIOS default settings.**)

ROM PCI/ISA BIOS BIOS FEATURES SETUP AWARD SOFTWARE, INC.			
CPU Internal Cache	: Enabled	Video BIOS Shadow	: Enabled
External Cache	: Enabled	C8000-CBFFF Shadow	: Disabled
Quick Power on Self Test	: Enabled	CC000-CFFFF Shadow	: Disabled
Boot Sequence	: A,C	D0000-D3FFF Shadow	: Disabled
Swap Floppy Drive	: Disabled	D4000-D7FFF Shadow	: Disabled
Boot Up NumLock Status	: On	D8000-DBFFF Shadow	: Disabled
Gate A20 Option	: Fast	DC000-DFFFF Shadow	: Disabled
Typematic Rate Setting	: Disabled		
Typematic Rate (Chars/Sec)	: 6	ESC : Quit	↑ ↓ → ← : Select Item
Typematic Delay (Msec)	: 250	F1 : Help	PU/PD/+/- : Modify
Security Option	: Setup	F5 : Old Values (Shift)F2 : Color	
PCI/VGA Palette Snoop	: Disabled	F6 : Load BIOS Defaults	
OS Select for DRAM >64MB	: Non-OS2	F7 : Load Setup Defaults	

2. Use the arrow keys to move between items and to select values. Modify the selected fields using the PgUp/PgDn/+/- keys. <F> keys are explained below:

<F1>: “Help” gives options available for each item.

Shift <F2>: Change color.

<F5>: Get the old values. These values are the values with which the user started the current session.

<F6>: Load all options with the BIOS Setup default values.

<F7>: Load all options with the Power-On default values.

A short description of screen items follows:

CPU Internal Cache This option enables/disables the CPU’s internal cache. (The Default setting is Enabled.)

External Cache This option enables/disables the external cache memory. (The Default setting is Enabled.)

Quick Power On Self Test Enabled provides a fast POST at boot-up .

Boot Sequence The default setting attempts to first boot from drive A: and then from hard disk C:. You can reverse this sequence with “C: A:”, but then drive A: cannot boot directly.

Swap Floppy Drive	Enabled changes the sequence of the A: and B: drives. (The Default setting is Disabled.)
Boot Up Num Lock Status	Choose On or Off. On puts numeric keypad in Num Lock mode at boot-up. Off puts this keypad in arrow key mode at boot-up.
Gate A20 Option	Choose Fast (default) or Normal. Fast allows RAM accesses above 1MB using the fast gate A20 line.
Typematic Rate Setting	Enable this option to adjust the keystroke repeat rate.
Typematic Rate (Chars/Sec)	Choose the rate a character keeps repeating.
Typematic Delay (Msec)	Choose how long after you press a key that a character begins repeating.
Security Option	Choose Setup or System. Use this feature to prevent unauthorized system boot-up or use of BIOS Setup. <p>“System” – Each time the system is booted the password prompt appears.</p> <p>“Setup” – If a password is set, the password prompt only appears if you attempt to enter the Setup program.</p>
PCI/VGA Palette Snoop	Enabled: The color of the monitor may be incorrect if used with MPEG card. Enable this option to make the monitor normal. Disabled: Default setting.
OS Select for DRAM >64MB	OS2: Choosing this when you are using OS/2 operation system. Non-OS/2: Choosing this when you are using non-OS/2 operation system.
Video or Adapter BIOS Shadow	BIOS shadow copies BIOS code from slower ROM to faster RAM. BIOS can then execute from RAM. These 16K segments can be shadowed from ROM to RAM. BIOS is shadowed in a 16K segment if it is enabled and it has BIOS present.

- After you have finished with the BIOS Features Setup program, press the <ESC> key and follow the screen instructions to save or disregard your settings.

Chipset Features Setup

The Chipset Features Setup option changes the values of the chipset registers. These registers control system options in the computer.

Note: Change these settings only if you are familiar with the Chipset. Run the Chipset Features Setup as follows.

1. Choose “CHIPSET FEATURES SETUP” from the Main Menu and the following screen appears. (The screen below shows default settings.)

ROM PCI/ISA BIOS CHIPSET FEATURES SETUP AWARD SOFTWARE, INC.			
Auto Configuration	: Enabled	8 Bit I/O Recovery Time	: 1
DRAM Speed Selection	: 70 ns	16 Bit I/O Recovery Time	: 1
DRAM RAS# Precharge Time	: 3	Memory Hole At 15M-16M	: Disabled
MA Additional Wait State	: Disabled		
RAS# To CAS# Delay	: Enabled		
DRAM Read Burst (B/E/F)	: x2/3/4		
DRAM Write Bursts (B/E/F)	: x3/3/3		
ISA Bus Clock	: PCICLK/4		
DRAM Refresh Queue	: Enabled		
DRAM RAS Only Refresh	: Disabled		
DRAM ECC/PARITY Select	: Disabled		
Read-Around-Write	: Enabled		
PCI Burst Write Combine	: Enabled		
PCI-TO-DRAM Pipeline	: Enabled	ESC : Quit	↑ ↓ → ← : Select Item
CPU-TO-PCI Write Post	: Enabled	F1 : Help	PU/PD/+/- : Modify
CPU-TO-PCI IDE Posting	: Enabled	F5 : Old Values (Shift)F2 : Color	
System BIOS Cacheable	: Disabled	F6 : Load BIOS Defaults	
Video RAM Cacheable	: Disabled	F7 : Load Setup Defaults	

2. Use the arrow keys to move between items and select values. Modify selected fields using the PgUp/PgDn/+/- keys.

A short description of screen items follows:

Auto Configuration Enable this option (strongly recommended) and the system automatically sets all options on the left side of the screen (except cache update mode & BIOS cacheable).

If this option is Enabled you must boot from Turbo mode.

DRAM Speed Selection Choose the right speed to fit your DRAM’s spec. 82440HX chipset supports 50, 60, and 70ns DRAM timing.

DRAM RAS# Precharge Time Use the default setting.

MA Additional Wait State	Use the default setting.
RAS# to CAS# Delay	Use the default setting.
DRAM Read Burst (B/E/F)	Use the default setting.
DRAM Write Burst (B/E/F)	Use the default setting.
ISA Clock	Use BIOS default setting or choose: /4: for 60, 66MHz CPU Bus Frequency /3: for 50, 55MHz CPU Bus Frequency.
DRAM Refresh Queue Turn-Around Insertion	Use the default setting.
DRAM RAS only Refresh	Use the default setting.
DRAM ECC/PARITY Select	Disabled: Disable any memory check function (default). Parity: Enable memory parity check function (when you have memory module with parity check function.) ECC: Enable memory ECC function (when you have memory module with ECC function.)
Read-Around-Write	Use the default setting.
PCI Burst Write Combine	Use the default setting.
PCI-TO-DRAM Pipeline	Use the default setting.
CPU-TO-PCI Write Posting	Use the default setting.
CPU-TO-PCI IDE Posting	Use the default setting.

System BIOS Cacheable	Disabled: The ROM area F0000H-FFFFFH is not cached. Enabled: The ROM area F0000H-FFFFFH is cacheable if cache controller is enabled.
Video BIOS Cacheable	Disabled: The video BIOS C0000H-C7FFFH is not cached. Enabled: The video BIOS C0000H-C7FFFH is cacheable if cache controller is enabled.
8Bit I/O Recovery Time	Use the default setting.
16Bit I/O Recovery Time	Use the default setting.
Memory Hole At 15M-16M	Choose Enabled or Disabled (default). Some interface cards will map their ROM address to this area. If this occurs, you should select Enabled, otherwise use Disabled.

3. After you have finished with the Chipset Features Setup, press the <ESC> key and follow the screen instructions to save or disregard your settings.

Power Management Setup

The Power Management Setup option sets the system's power saving functions.

Run the Power Management Setup as follows.

1. Choose "POWER MANAGEMENT SETUP" from the Main Menu and a screen with a list of items appears.

ROM PCI/ISA BIOS CMOS SETUP UTILITY POWER MANAGEMENT SETUP	
Power Management	: Disabled
PM Control by APM	: No
Video Off Method	: V/H SYNC+Blank
Doze Mode	: Disabled
Standby Mode	: Disabled
Suspend Mode	: Disabled
HDD Power Down	: Disabled
** Wake Up Events In Doze & Standby **	
IRQ3 (Wake-Up Event)	: ON
IRQ4 (Wake-Up Event)	: ON
IRQ8 (Wake-Up Event)	: ON
IRQ12 (Wake-Up Event)	: ON
** Power Down & Resume Events **	
IRQ 3 (COM 2)	: ON
IRQ 4 (COM 1)	: ON
IRQ 5 (LPT 2)	: ON
IRQ 6 (Floppy Disk)	: OFF
IRQ 7 (LPT 1)	: ON
IRQ 8 (RTC Alarm)	: OFF
IRQ 9 (IRQ2 Redir)	: ON
IRQ 10 (Reserved)	: ON
IRQ 11 (Reserved)	: ON
IRQ 12 (PS/2 mouse)	: ON
IRQ 13 (Coprocessor)	: ON
IRQ 14 (Hard Disk)	: ON
IRQ 15 (Reserved)	: ON
ESC : Quit ↑ ↓ → ←: Select Item	
F1 : Help PU/PD/+/- : Modify	
F5 : Old Values (Shift)F2 : Color	
F6 : Load BIOS Defaults	
F7 : Load Setup Defaults	

2. Use the arrow keys to move between items and to select values. Modify the selected fields using the PgUp/PgDn/+/- keys.

A short description of selected screen items follows:

Power Management	Options are as follows:
User Define	Let's you define the HDD and power down times.
Disabled	Disables the Green PC Features.
Min Saving	Doze timer = 1 Hour Standby timer = 1 Hour Suspend timer = 1 Hour HDD Power Down = 15 Min
Max Saving	Doze timer = 1 Min Standby timer = 1 Min Suspend timer = 1 Min HDD Power Down = 1 Min

PM Control by APM	Choose Yes or No (default). APM stands for Advanced Power Management. To use APM, you must run “power.exe” under DOS v6.0 or later version.
Video Off Method	Choose V/H Sync+Blank (default), Blank screen, or DPMS for the selected PM mode.
Doze Mode	When the set time has elapsed, the BIOS sends a command to the system to enter doze mode (system clock drops to 33MHz). Time is adjustable from 1 Min to 1 Hour.
Standby Mode	The default is Disabled. Time is adjustable from 1 Min to 1 Hour.
Suspend Mode	The default is Disabled. Only an SL-Enhanced (or SMI) CPU can enter this mode. Time is adjustable from 1 Min to 1 Hour. Under Suspend mode, the CPU stops completely (no instructions are executed.)
HDD Power Down	When the set time has elapsed, the BIOS sends a command to the HDD to power down, which turns off the motor. Time is adjustable from 1 to 15 minutes. The default setting is Disabled. Some older model HDDs may not support this advanced function.
IRQx (Wake-Up Events)	The BIOS monitors these items for activity. If activity occurs from the Enabled item the system wakes up.
Power Down Activities	The BIOS monitors these items for no activity. If no activity occurs from the Enabled item the system will enter power saving mode (Doze/Standby/Suspend/ HDD Power Down mode) .

3. After you have finished with the Power Management Setup, press the <ESC> key to return to the Main Menu.

PNP/PCI Configuration Setup

This option sets the mainboard's PCI Slots. Run this option as follows:

1. Choose "PNP/PCI CONFIGURATION SETUP" from the Main Menu and the following screen appears. (The screen below shows default settings.)

ROM PCI/ISA BIOS
PNP/PCI CONFIGURATION
AWARD SOFTWARE, INC.

Resources Controlled By : Manual	PCI IRQ Activated By : Level
Reset Configuration Data : Disabled	PCI IDE IRQ Map To : PCI-AUTO
	Primary IDE INT# : A
	Secondary IDE INT# : B
IRQ-3 assigned to : Legacy ISA*	
IRQ-4 assigned to : Legacy ISA*	
IRQ-5 assigned to : PCI/ISA PnP*	
IRQ-7 assigned to : Legacy ISA*	
IRQ-9 assigned to : PCI/ISA PnP*	
IRQ-10 assigned to : PCI/ISA PnP*	
IRQ-11 assigned to : PCI/ISA PnP*	
IRQ-12 assigned to : PCI/ISA PnP*	
IRQ-14 assigned to : Legacy ISA*	
IRQ-15 assigned to : Legacy ISA*	
DMA-0 assigned to : PCI/ISA PnP*	
DMA-1 assigned to : PCI/ISA PnP*	
DMA-3 assigned to : PCI/ISA PnP*	
DMA-5 assigned to : PCI/ISA PnP*	
DMA-6 assigned to : PCI/ISA PnP*	
DMA-7 assigned to : PCI/ISA PnP*	
	ESC : Quit ↑ ↓ → ← : Select Item
	F1 : Help PU/PD/+/- : Modify
	F5 : Old Values (Shift)F2 : Color
	F6 : Load BIOS Defaults
	F7 : Load Setup Defaults

*: These items will disappear when Resource Controlled. is Auto.

2. Use the arrow keys to move between items and select values. Modify selected fields using the PgUp/PgDn/+/- keys.

A short description of screen items follows:

Resources Controlled By	Manual:	BIOS doesn't manage PCI/ISA PnP card (i.e., IRQ) automatically.
	Auto:	BIOS auto manage PCI and ISA PnP card (recommended).
Reset Configuration Data	Disabled:	Retain PnP configuration data in BIOS.
	Enabled:	Reset PnP configuration data in BIOS.

IRQX and DMAX assigned to	Choose PCI/ISA PnP or Legacy ISA. If the first item is set to Manual, you could choose IRQX and DMAX assigned to PCI/ISA PnP card or ISA card. PCI/ISA PnP: BIOS auto assigns IRQ/DMA to the device. Legacy ISA: User assigns IRQ/DMA to the device.
PCI IRQ Activated By	Choose Edge or Level. Most PCI trigger signals are Level. This setting must match the PCI card.
PCI IDE IRQ Map To	Select PCI-AUTO, ISA, or assign a PCI SLOT number (depending on which slot the PCI IDE is inserted). The default setting is PCI-AUTO. If PCI-AUTO does not work, then assign an individual PCI SLOT number.
Primary IDE INT#	Choose INTA#, INTB#, INTC#, or INTD#. The default setting is INTA#.
Secondary IDE INT#	Choose INTA#, INTB#, INTC#, or INTD#. The default setting is INTB#.

3. After you have finished with the PCI Slot Configuration, press the <ESC> key and follow the screen instructions to save or disregard your settings.

Load Setup Defaults

This item loads the system values you have previously saved. Choose this item and the following message appears:

“Load SETUP Defaults (Y/N)? N”

To use the SETUP defaults, change the prompt to “Y” and press <Enter>.

Note: The SETUP Defaults are optimized for the most stabilized performance.

Load BIOS Defaults

Choose this item and the following message appears:

“Load BIOS Defaults (Y/N)?N”

To use the BIOS defaults, change the prompt to “Y” and press <Enter>.

Note: BIOS DEFAULTS values are adjusted for high performance. If you run into any problems after loading BIOS DEFAULTS, please load the SETUP DEFAULTS for the stable performance.

Integrated Peripherals

The Integrated Peripherals option changes the values of the chipset registers. These registers control system options in the computer.

Note: Change these settings only if you are familiar with the Chipset.

Run the Integrated Peripherals as follows.

1. Choose “Integrated Peripherals” from the Main Menu and the following screen appears. (The screen below shows default settings.,

ROM PCI/ISA BIOS INTEGRATED PERIPHERALS AWARD SOFTWARE, INC.	
IDE HDD Block Mode : Enabled	USB Controller : Enabled
IDE Primary Master PIO : Auto	
IDE Primary Slave PIO : Auto	
IDE Secondary Master PIO : Auto	
IDE Secondary Slave PIO : Auto	
On-Chip Primary PCI IDE: Enabled	
On-Chip Secondary PCI IDE: Enabled	
PCI Slot IDE 2nd Channel : Enabled	
Onboard FDD Controller : Enabled	
Onboard Serial Port 1 : 3F8/IRQ4	
Onboard Serial Port 2 : 2F8/IRQ3	
UART 2 Mode : Standard	
Onboard Parallel Port : 378H/IRQ7	
Onboard Parallel MODE : ECP/EPP	
ECP Mode Use DMA : 3	
Parallel Port EPP Type : EPP1.9	
	ESC : Quit ↑ ↓ → ← : Select Item
	F1 : Help PU/PD/+/- : Modify
	F5 : Old Values (Shift)F2 : Color
	F6 : Load BIOS Defaults
	F7 : Load Setup Defaults

2. Use the arrow keys to move between items and select values. Modify selected fields using the PgUp/PgDn/+/- keys.

A short description of screen items follows:

IDE HDD Block Mode	Choose Enabled (default) or Disabled. Enabled invokes multi-sector transfer instead of one sector per transfer. Not all HDDs support this function.
IDE Primary Master PIO	Choose Auto (default) or mode 0~4. Mode 0 is the slowest speed, and HDD mode 4 is the fastest speed. For better performance and stability, we suggest you use the Auto setting to set the HDD control timing.
IDE Primary Slave PIO	
IDE Secondary Master PIO	
IDE Secondary Slave PIO	
On-chip Primary/ Secondary PCI IDE	Enabled: Use the on-board IDE (default) Disabled: Turn off the on-board IDE
PCI Slot IDE 2nd Channel	Choose Enabled (default) or Disabled. When Enabled is set, IRQ15 is dedicated for secondary IDE use. When Disabled is set, IRQ15 is released for other devices.
Onboard FDC Controller	Enabled: Use the on-board floppy controller (default). Disabled: Turn off the on-board floppy controller.
Onboard Serial Port 1	Choose serial port 1 & 2's I/O address. Do not set port 1 & 2 to the same value except for Disabled.
Onboard Serial Port 2	
	COM 1/3F8H COM3/3E8H COM 2/2F8H COM4/2E8H (default)
UART 2 Mode	Standard: Use standard UART mode (default). ASK IR: Use UART with ASK. IR function enable. HPSIR: Use UART with HP.. Serial IR function enable.

Onboard Parallel Port	Choose the printer I/O address: 378H/IRQ7 (default), 3BCH/IRQ7, 278H/IRQ5
Onboard Printer Mode	Choose SPP, ECP, EPP/SPP, or ECP/EPP mode. The mode depends on your external device that connects to this port.
ECP Mode Use DMA	Choose 3 (default) or 1 to select DMA3 or DMA1 when using the ECP device.
Parallel Port EPP Type	Choose EPP specification Ver. 1.7 (default) or 1.9.
USB Controller	Enable it when you are using the USB device.

Supervisor Password

Based on the setting you made in the “Security Option” of the “BIOS FEATURES SETUP”, this Main Menu item lets you configure the system so that a password is required every time the system boots or an attempt is made to enter the Setup program. Change the password as follows:

1. Choose “SUPERVISOR PASSWORD” in the Main Menu and press <Enter>. The following message appears:

“Enter Password:”

2. Enter a password and press <Enter>.
(If you do not wish to use the password function, you can just press <Enter> and a “Password disabled” message appears.)
3. After you enter your password, the following message appears prompting you to confirm the new password:

“Confirm Password:”

4. Re-enter your password and then Press <ESC> to exit to the Main Menu.
5. You have the right to change any changeable settings in the “CMOS SETUP UTILITY.”

Important: If you forget or lose the password, the only way to access the system is to set jumper JP5 to clear the CMOS RAM. All setup information is lost and you must run the BIOS setup program again.

User Password

Based on the setting you made in the “Security Option” of the “BIOS FEATURES SETUP”, this Main Menu item lets you configure the system so that a password is required every time the system boots or an attempt is made to enter the Setup program. Change the password as follows:

1. Choose “USER PASSWORD” in the Main Menu and press <Enter>. The following message appears:

“Enter Password:”

2. Enter a password and press <Enter>. (If you do not wish to use the password function, you can just press <Enter> and a “Password disabled” message appears.)
3. After you enter your password, the following message appears prompting you to confirm the new password:

“Confirm Password:”

4. Re-enter your password and then Press <ESC> to exit to the Main Menu.
5. You are not allowed to change any setting in “CMOS SETUP UTILITY” except change user’s password.

Important: If you forget or lose the password, the only way to access the system is to set jumper JP5 to clear the CMOS RAM. All setup information is lost and you must run the BIOS setup program again.

IDE HDD Auto Detection

This Main Menu item automatically detects the hard disk type and configures the STANDARD CMOS SETUP accordingly.

*Note: This function is only valid for **IDE** hard disks.*

ROM PCI/ISA BIOS
CMOS SETUP UTILITY
AWARD SOFTWARE, INC.

HARD DISKS	TYPE	SIZE	CYLS	HEAD	PRECOMP	LANDZ	SECTOR	MODE
Primary Master	: None	0	0	0	0	0	0	----
Primary Slave	: None	0	0	0	0	0	0	----
Secondary Master	: None	0	0	0	0	0	0	----
Secondary Slave	: None	0	0	0	0	0	0	----

Do you accept this drive C (Y/N)? N

ESC : Skip

4 Drivers Installation Guide

Triones IDE Bus Master Drivers Installation Guide is for Intel PIIX/PIIX3 Chipset.

MS-DOS/WINDOW/WFW

- 1) You should install CD-ROM in secondary channel in Windows (WFW).
- 2) Change the current directory to a: or b:.
- 3) Under DOS command line prompt, run the SETUP directly.

After entering the setup utility, just follow the instructions of the setup.

WINDOWS NT3.5

- 1) From the Program Manager, double click on “Windows NT Setup” in the Main group.
- 2) Select “Options/Add/Remove SCSI Adapters...”.
- 3) Click on Add.
- 4) The “Select SCSI Adapter Option” dialog will appear; select “Other (Requires a disk from a hardware manufacturer)” from the “Adapter:” list box.
- 5) Next, the “Insert Diskette” dialog box will appear; insert the Triones PIIX/PIIX3 Bus Master EIDE/ATAPI Driver disk into Drive A: and type in “a:\winnt35” and <Return>.
- 6) Next, the “Select OEM Option” dialog box will appear; select “PIIX/PIIX3 Bus Master EIDE/ATAPI” and click “OK”.
- 7) Next, the “Select SCSI Adapter Option” dialog box will appear; click on the “Install” button in the dialog box. If installation is successful, the “SCSI Adapter Setup” dialog box will reappear, and “PIIX/PIIX3 Bus Master EIDE/ATAPI” will be listed. That means the driver is installed.
- 8) Reboot your system to load the driver.

WINDOWS 95

- 1) Close any running applications.
- 2) Insert the floppy disk into drive A:.
- 3) Open "My Computer", double click "Drive A:".
- 4) Double click "Win95".
- 5) Double click the Setup program.
- 6) Then just follow the instruction.

NOVELL 3.X&4.X

- 1) Copy the driver TRIN4X.DSK or TRIN312.DSK to the subdirectory which holds the file SERVER.EXE.
- 2) Boot up the file server.
- 3) On the system console and on the command prompt state, type in:
load TRIN4X.DSK <Enter> or **load TRIN312.DSK <Enter>**

You can also include the above command line into the start up file STARTUP.NCF to load the driver automatically.

SCO UNIX

- 1) Install SCO UNIX 3.2.x or SCO Open Desktop 3.x using the default SCO IDE driver.
- 2) Reboot your SCO UNIX system
- 3) Insert Triones supplied diskette into the 3.5 inch floppy drive of your system. Use doscp command to copy the file TRISCO.TAR to your /tmp directory. for example, if you are using floppy drive A, type: doscp a:/scounix/trisco.tar/tmp/trisco.tar

- 4) From root directory, type the following commands:
mkdir/inst
cd /inst
tar xvf /tmp/trisco.tar.
(Note: there is a period at the end of the last command.)
- 5) Now, insert a blank diskette into the floppy drive A and type:
tar cvf /dev/<your floppy drive A device name>.
(Note: there is a period at the end of the last command.)

Your floppy drive A device name could be:

- rfd096ds15,5.25 DSHD
- rfd0135ds18 3.5 DSHD
- rfd048ds9 5.25 DSDD
- rfd0135ds9 3.5 DSDD

Now you have already made an installation diskette for the device driver.

Start the installation by typing: **custom**.

- 6) Select the "Install" operation and then follow the guided steps.
When prompted "Do you want to set the device configuration (y/n)", answer "n".
- 7) Reboot your SCO UNIX system.

SCO UNIX 5.0

- 1) Install SCO UNIX 5.0 using the default SCO IDE driver.
- 2) Reboot your SCO UNIX system
- 3) Insert Triones supplied diskette into the 3.5 inch floppy drive of your system. Use doscp command to copy the file TRISCO.TAR to your /tmp directory. for example, if you are using floppy drive A, type: doscp a:/scounix/trisco5.tar/tmp/trisco5.tar

- 4) From root directory, type the following commands:
mkdir/inst
cd /inst
tar xvf /tmp/trisco.tar.
(Note: there is a period at the end of the last command.)
- 5) Install the driver by typing:
./install
- 6) Reboot your SCO UNIX system..

OS/2 2.0 and WARP 3.X

- 1) Copy TRIOS2.ADD from the floppy diskette to your hard disk under the OS2 directory (i.e., C:\OS2).
- 2) Edit C:\CONFIG.SYS to replace **BASEDEV=IBM1S506.ADD** with **BASEDEV=TRIOS2.ADD**
- 3) Reboot the system.

Note: For more information (like parameter settings, driver de-installation, etc.), please refer to the README.TXT file on the diskette.