

ASUS[®] MEZ-M

Socket 370 microATX Motherboard

USER'S MANUAL

USER'S NOTICE

No part of this manual, including the products and software described in it, may be reproduced, transmitted, transcribed, stored in a retrieval system, or translated into any language in any form or by any means, except documentation kept by the purchaser for backup purposes, without the express written permission of ASUSTeK COMPUTER INC. ("ASUS").

ASUS PROVIDES THIS MANUAL "AS IS" WITHOUT WARRANTY OF ANY KIND, EITHER EXPRESS OR IMPLIED, INCLUDING BUT NOT LIMITED TO THE IMPLIED WARRANTIES OR CONDITIONS OF MERCHANTABILITY OR FITNESS FOR A PARTICULAR PURPOSE. IN NO EVENT SHALL ASUS, ITS DIRECTORS, OFFICERS, EMPLOYEES OR AGENTS BE LIABLE FOR ANY INDIRECT, SPECIAL, INCIDENTAL, OR CONSEQUENTIAL DAMAGES (INCLUDING DAMAGES FOR LOSS OF PROFITS, LOSS OF BUSINESS, LOSS OF USE OR DATA, INTERRUPTION OF BUSINESS AND THE LIKE), EVEN IF ASUS HAS BEEN ADVISED OF THE POSSIBILITY OF SUCH DAMAGES ARISING FROM ANY DEFECT OR ERROR IN THIS MANUAL OR PRODUCT.

Product warranty or service will not be extended if: (1) the product is repaired, modified or altered, unless such repair, modification or alteration is authorized in writing by ASUS; or (2) the serial number of the product is defaced or missing.

Products and corporate names appearing in this manual may or may not be registered trademarks or copyrights of their respective companies, and are used only for identification or explanation and to the owners' benefit, without intent to infringe.

- Intel, LANDesk, and Pentium are registered trademarks of Intel Corporation.
- IBM and OS/2 are registered trademarks of International Business Machines.
- Symbios is a registered trademark of Symbios Logic Corporation.
- Windows and MS-DOS are registered trademarks of Microsoft Corporation.
- XGstudio and Soft Synthesizer is a trademark of the Yamaha Corporation.
- Adobe and Acrobat are registered trademarks of Adobe Systems Incorporated.

The product name and revision number are both printed on the product itself. Manual revisions are released for each product design represented by the digit before and after the period of the manual revision number. Manual updates are represented by the third digit in the manual revision number.

For previous or updated manuals, BIOS, drivers, or product release information, contact ASUS at <http://www.asus.com.tw> or through any of the means indicated on the following page.

SPECIFICATIONS AND INFORMATION CONTAINED IN THIS MANUAL ARE FURNISHED FOR INFORMATIONAL USE ONLY, AND ARE SUBJECT TO CHANGE AT ANY TIME WITHOUT NOTICE, AND SHOULD NOT BE CONSTRUED AS A COMMITMENT BY ASUS. ASUS ASSUMES NO RESPONSIBILITY OR LIABILITY FOR ANY ERRORS OR INACCURACIES THAT MAY APPEAR IN THIS MANUAL, INCLUDING THE PRODUCTS AND SOFTWARE DESCRIBED IN IT.

Copyright © 1998 ASUSTeK COMPUTER INC. All Rights Reserved.

Product Name:	ASUS MEZ-M
Manual Revision:	1.03 E322
Release Date:	January 1999

ASUS CONTACT INFORMATION

ASUSTeK COMPUTER INC. (Asia-Pacific)

Marketing

Address: 150 Li-Te Road, Peitou, Taipei, Taiwan 112
Telephone: +886-2-2894-3447
Fax: +886-2-2894-3449
Email: info@asus.com.tw

Technical Support

Tel (English): +886-2-2894-3447 ext. 706
Tel (Chinese): +886-2-2894-3447 ext. 701
Fax: +886-2-2895-9254
Email: tsd@asus.com.tw
Newsgroup: news2.asus.com.tw
WWW: www.asus.com.tw
FTP: ftp.asus.com.tw/pub/ASUS

ASUS COMPUTER INTERNATIONAL (America)

Marketing

Address: 6737 Mowry Avenue, Mowry Business Center, Building 2
Newark, CA 94560, USA
Fax: +1-510-608-4555
Email: info-usa@asus.com.tw

Technical Support

Fax: +1-510-608-4555
BBS: +1-510-739-3774
Email: tsd-usa@asus.com.tw
WWW: www.asus.com
FTP: ftp.asus.com.tw/pub/ASUS

ASUS COMPUTER GmbH (Europe)

Marketing

Address: Harkort Str. 25, 40880 Ratingen, BRD, Germany
Telephone: 49-2102-445011
Fax: 49-2102-442066
Email: info-ger@asus.com.tw

Technical Support

Hotline: 49-2102-499712
BBS: 49-2102-448690
Email: tsd-ger@asus.com.tw
WWW: www.asuscom.de
FTP: ftp.asuscom.de/pub/ASUSCOM

CONTENTS

I. INTRODUCTION	7
How this manual is organized	7
Item Checklist	7
II. FEATURES	8
The ASUS MEZ-M Motherboard	8
Introduction to ASUS Smart Series Motherboards	9
Parts of the ASUS MEZ-M Motherboard	11
III. HARDWARE SETUP	12
ASUS MEZ-M Motherboard Layout	12
Hardware Setup Steps	14
1. Motherboard Settings	14
2. System Memory (DIMM)	17
SPD Support	17
DIMM Memory Installation	18
3. Central Processing Unit (CPU)	19
4. Expansion Cards	21
Expansion Card Installation Procedure	21
Assigning IRQs for Expansion Cards	21
Assigning DMA Channels for ISA Cards	22
ISA Cards and Hardware Monitor	22
5. External Connectors	23
Power Connection Procedures	35
Flash Memory Writer Utility	36
IV. BIOS SETUP	36
Main Menu	36
Managing and Updating Your Motherboard's BIOS	38
6. BIOS Setup	39
Load Defaults	40
Standard CMOS Setup	40
Details of Standard CMOS Setup:	40
BIOS Features Setup	43
Details of BIOS Features Setup	43
Chipset Features Setup	46
Details of Chipset Features Setup	46
Power Management Setup	49
Details of Power Management Setup	49
PNP and PCI Setup	52
Details of PNP and PCI Setup	52
Load BIOS Defaults	54
Load Setup Defaults	54

CONTENTS

Supervisor Password and User Password	55
IDE HDD Auto Detection	56
Save & Exit Setup	57
Exit Without Saving	57
V. SOFTWARE SETUP	59
VI. SOFTWARE REFERENCE.....	73

FCC & DOC COMPLIANCE

Federal Communications Commission Statement

This device complies with FCC Rules Part 15. Operation is subject to the following two conditions:

- This device may not cause harmful interference, and
- This device must accept any interference received, including interference that may cause undesired operation.

This equipment has been tested and found to comply with the limits for a Class B digital device, pursuant to Part 15 of the FCC Rules. These limits are designed to provide reasonable protection against harmful interference in a residential installation. This equipment generates, uses and can radiate radio frequency energy and, if not installed and used in accordance with manufacturer's instructions, may cause harmful interference to radio communications. However, there is no guarantee that interference will not occur in a particular installation. If this equipment does cause harmful interference to radio or television reception, which can be determined by turning the equipment off and on, the user is encouraged to try to correct the interference by one or more of the following measures:

- Re-orient or relocate the receiving antenna.
- Increase the separation between the equipment and receiver.
- Connect the equipment to an outlet on a circuit different from that to which the receiver is connected.
- Consult the dealer or an experienced radio/TV technician for help.

WARNING! Be sure that there is sufficient air circulation across the processor's heatsink by regularly checking that your CPU fan is working. Without sufficient circulation, the processor could overheat and damage both the processor and the motherboard. You may install an auxiliary fan, if necessary.

Canadian Department of Communications Statement

This digital apparatus does not exceed the Class B limits for radio noise emissions from digital apparatus set out in the Radio Interference Regulations of the Canadian Department of Communications.

I. INTRODUCTION

How this manual is organized

This manual is divided into the following sections:

- | | |
|-------------------------------|---|
| I. Introduction | Manual information and checklist |
| II. Features | Information and specifications concerning this product |
| III. Hardware Setup | Instructions on setting up the motherboard |
| IV. BIOS Setup | Instructions on setting up the BIOS software |
| V. Software Setup | Information on setting up the included support software |
| VI. Software Reference | Reference material for the included support software |

Item Checklist

Check that your package is complete. If you discover damaged or missing items, please contact your retailer.

- (1) ASUS Motherboard
- (1) IDE ribbon cable for master and slave drives
- (1) Floppy ribbon cable for (1) 5.25" floppy and (2) 3.5" floppies
- (1) Bag of spare jumper caps
- (1) Support CD with drivers and utilities
- (1) This Motherboard User's Manual

- IrDA-compliant infrared module (optional)
- ASUS PCI-L101 Wake-On-LAN 10/100 Fast Ethernet Card (optional)
- CIDB module (optional)

II. FEATURES

The ASUS MEZ-M Motherboard

The ASUS MEZ-M motherboard is carefully designed for the demanding PC user who wants many intelligent features in a small package.

- **Intel Processor Support:** Supports Intel's Celeron processor designed for the Socket 370 and packaged in Plastic Pin Grid Array (PPGA).
- **Intel AGPset:** Features Intel's 440ZX AGPset with I/O subsystems and front side bus (FSB) platform, which boosts the traditional 66MHz internal bus to 100MHz.
- **Enhanced ACPI & Anti-Boot Virus BIOS:** Programmable BIOS (Flash EEPROM), offering enhanced ACPI for Windows 98 compatibility, built-in hardware-based virus protection, and autodetection of most devices for virtually automatic setup.
- **Versatile Memory:** Equipped with three DIMM sockets to support Intel PC100-compliant SDRAMs (8, 16, 32, 64, 128, or 256MB) up to 256MB.
- **AGP Slot:** Supports an Accelerated Graphics Port card for high performance, component level interconnect targeted at 3D graphical display applications supporting a 1x (66MHz) or a 2x (133MHz) mode bus.
- **Onboard Audio (optional):** Features an ESS Solo-1 32-bit PCI audio onboard. Includes a complete online help to guide you through the audio software.
- **PCI & ISA Expansion:** Provides three 32-bit PCI expansion slots and one 16-bit ISA expansion slot.
- **PC Health Monitoring:** Provides an easier way to examine and manage system status information such as CPU and system voltages, temperatures, and fan status through the onboard hardware ASIC and the bundled LDCM by Intel or PC Probe from ASUS.
- **Wake-On-LAN Header:** Supports Wake-On-LAN activity through an optional ASUS PCI-L101 Fast Ethernet card or a similar ethernet card.
- **SB-Link™:** Features Creative's SB-Link™, allowing SB16 compatibility, using Intel's PC-PCI and serialized IRQ protocols, to AWE64D or compatible PCI audio cards.
- **Super Multi-I/O:** Provides two high-speed UART compatible serial ports and one parallel port with EPP and ECP capabilities.
- **Desktop Management Interface (DMI):** Supports DMI through BIOS, which allows hardware to communicate within a standard protocol creating a higher level of compatibility. (Requires DMI-enabled components.)
- **Ultra DMA/33 BM IDE:** Comes with an onboard PCI Bus Master IDE controller with two connectors that support four IDE devices in two channels, supports Ultra DMA/33, PIO Modes 3 and 4 and Bus Master IDE DMA Mode 2, and supports Enhanced IDE devices, such as Tape Backup, CD-ROM, and LS-120 drives.
- **Easy Installation:** Equipped with BIOS that supports autodetection of hard drives, PS/2 mouse, and Plug and Play devices to make setup of hard drives, expansion cards, and other devices virtually automatic.
- **IrDA:** Supports an optional infrared port module for wireless interface.
- **Quick Adjustments:** Changing CPU and onboard features settings is a snap with easy-to-access DIP switches.

II. FEATURES

Introduction to ASUS Smart Series Motherboards

Performance

- **ACPI Ready:** ACPI (Advanced Configuration and Power Interface) is also implemented on all ASUS smart series motherboards. ACPI provides more Energy Saving Features for future operating systems (OS) supporting OS Direct Power Management (OSPM) functionality. With these features implemented in the OS, PCs can be ready around the clock, yet satisfy all the energy saving standards. To fully utilize the benefits of ACPI, an ACPI-supported OS such as the successor of Windows 95 must be used.
- **Double the IDE Transfer Speed:** IDE transfers using UltraDMA/33 Bus Master IDE can handle rates up to 33MB/sec. The best of all is that this new technology is compatible with existing ATA-2 IDE specifications so there is no need to upgrade current hard drives or cables.
- **Concurrent PCI:** Concurrent PCI allows multiple PCI transfers from PCI master buses to memory to CPU.
- **PC'98 Compliant:** Both the BIOS and hardware levels of the motherboard meets PC'98 compliancy. The new PC'98 requirements for systems and components are based on the following high-level goals: Support for Plug and Play compatibility and power management for configuring and managing all system components, and 32-bit device drivers and installation procedures for Windows 95/98/NT.
- **SDRAM Optimized Performance:** ASUS smart series motherboards support the new generation memory, Synchronous Dynamic Random Access Memory (SDRAM), which increases the data transfer rate from 264MB/s max using EDO memory to 800MB/s max using PC100 SDRAM.

II. FEATURES

Intelligence (some features require the optional Hardware/Thermal Monitor)

- **Fan Status Monitoring and Alarm:** To prevent system overheat and system damage, the CPU, power supply, and system fans can be monitored for RPM and failure. All the fans are set for its normal RPM range and alarm thresholds.
- **Temperature Monitoring and Alert:** To prevent system overheat and system damage, there are heat sensors to monitor the CPU and system temperatures to warn of damaging temperatures.
- **Voltage Monitoring and Alert:** System voltage levels are monitored to ensure stable current to critical motherboard components. Voltage specifications are more critical for future processors, so monitoring is necessary to ensure proper system configuration and management.
- **System Resources Alert:** Today's operating systems such as Windows 95, Windows NT, and OS/2, require much more memory and hard drive space to present enormous user interfaces and run large applications. The system resource monitor will warn the user before the system resources are used up to prevent possible application crashes. Suggestions will give the user information on managing their limited resources more efficiently.
- **Auto Fan Off:** The system fans will power off automatically **even in sleep mode**. This function reduces both energy consumption *and* **system noise**, and is an important feature to implement silent PC systems.
- **Dual Function Power Button:** The system can be in one of two states, one is Sleep mode and the other is the Soft-Off mode. Pushing the power button for less than 4 seconds places the system into Sleep mode. When the power button is pressed for more than 4 seconds, it enters the Soft-Off mode.
- **Remote Ring On (requires modem):** This allows a computer to be turned on remotely through an internal or external modem. With this benefit on-hand, any user can access vital information from their computer from anywhere in the world!
- **Message LED (requires ACPI OS support):** Chassis LEDs now act as information providers. Through the way a particular LED illuminates, the user can determine the stage the computer is in. A simple glimpse provides useful information to the user.
- **Keyboard Power Up:** Keyboard Power Up can be enabled or disabled to allow the computer to be powered on by pressing the space bar on the keyboard.
- **Chassis Intrusion Detection:** Supports chassis-intrusion monitoring through the ASUS optional CIDB module and LDCM.

II. FEATURES

Parts of the ASUS MEZ-M Motherboard

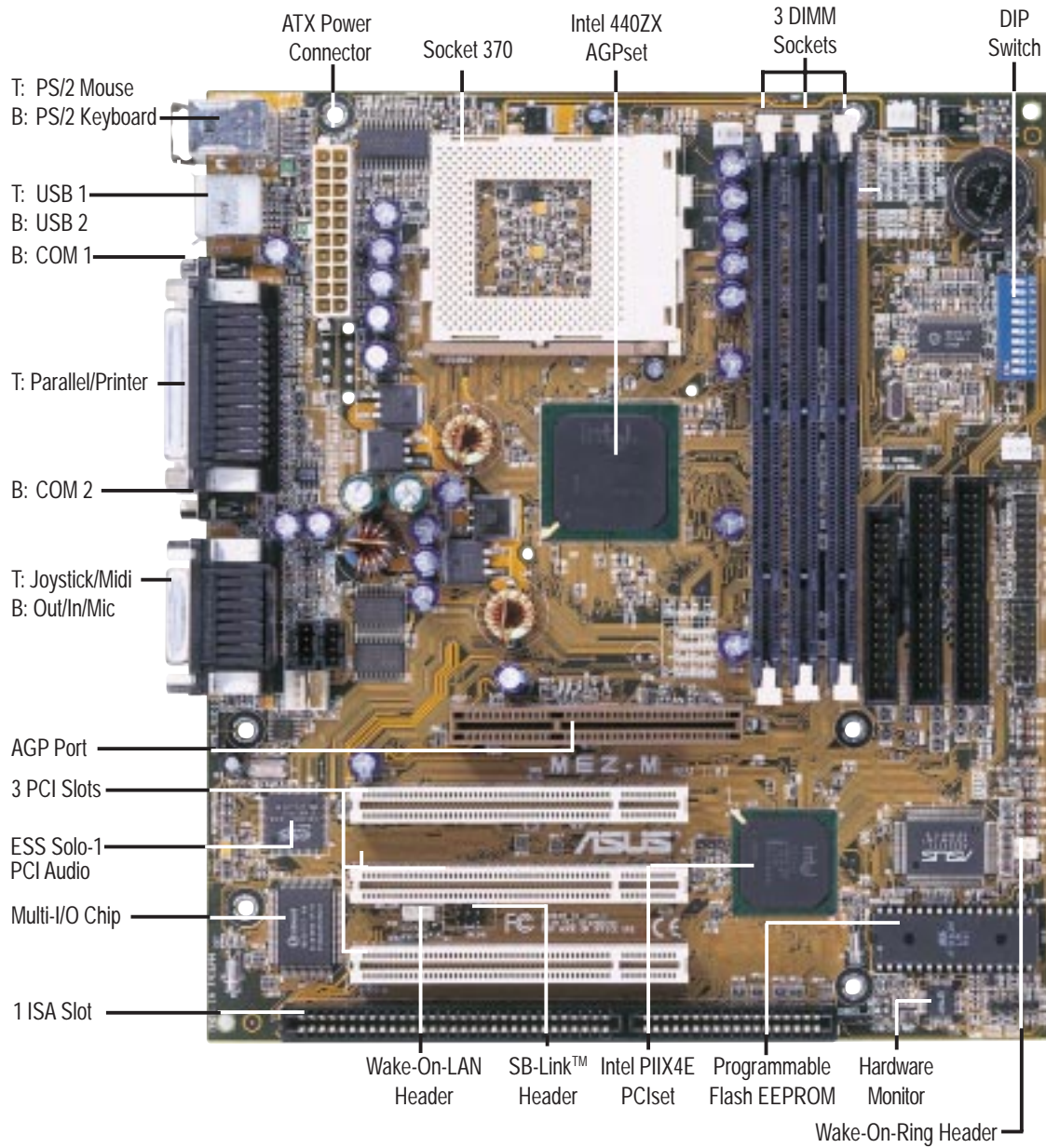

II. FEATURES
Motherboard Parts

III. HARDWARE SETUP

ASUS MEZ-M Motherboard Layout

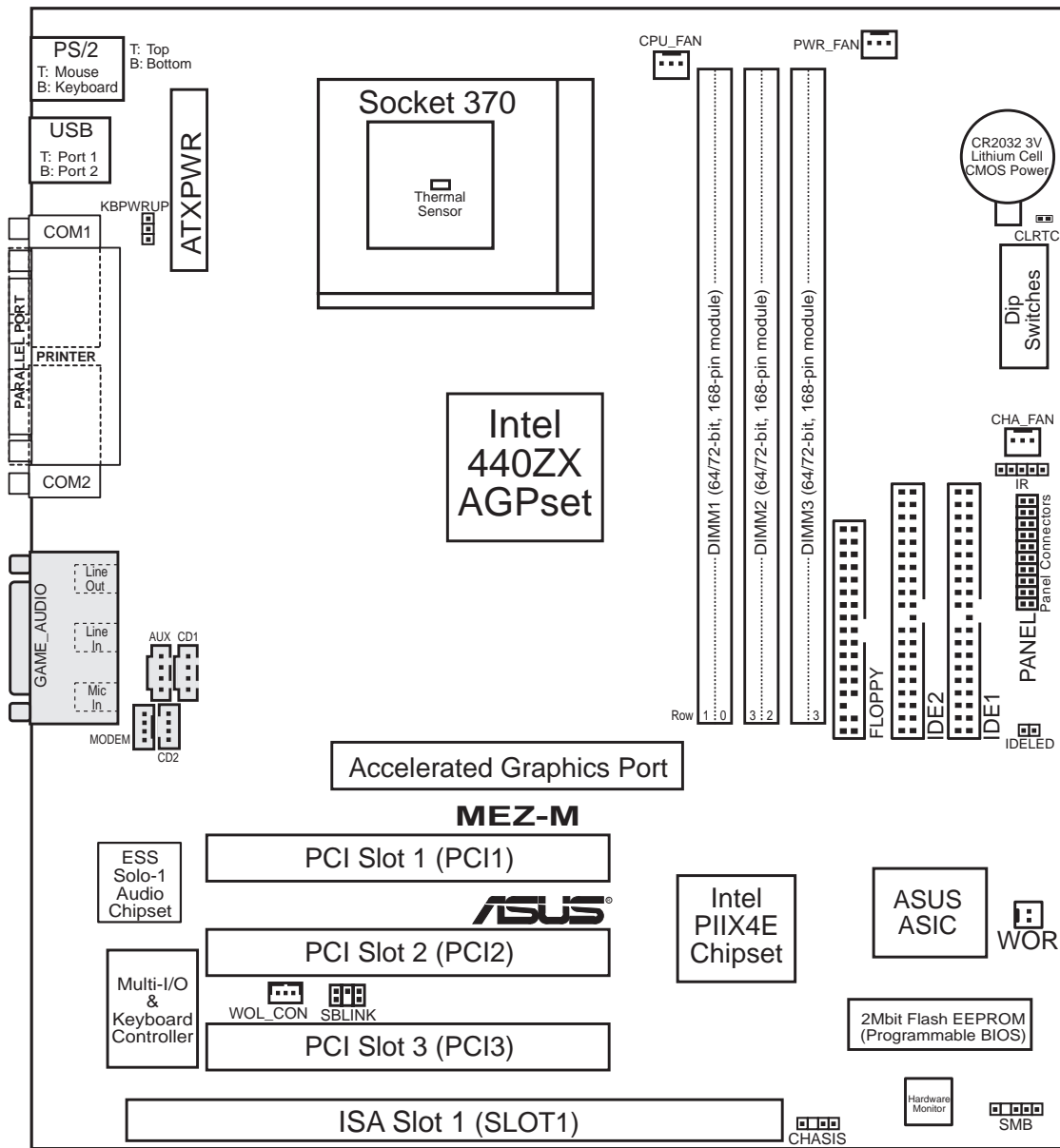

(Grayed items are optional at the time of purchase.)

III. INSTALLATION
Motherboard Layout

III. HARDWARE SETUP

Motherboard Settings

- | | |
|----------------|--|
| 1) KBPWRUP | p. 14 Keyboard Power Up (Enable/Disable) |
| 3) DIP5 | p. 15 VIO Setting |
| 2) DIP6 | p. 15 Onboard Audio Setting |
| 4) DIP1,2,3,4 | p. 16 CPU Bus Frequency |
| 5) DIP7,8,9,10 | p. 16 CPU Core:Bus Frequency Multiple |

Expansion Slots

- | | |
|------------------------|--|
| 1) DIMM1, DIMM2, DIMM3 | p. 17 168-Pin DIMM Memory Support |
| 2) Socket 370 | p. 19 Central Processing Unit (CPU) Socket |
| 3) SLOT1 | p. 21 16-bit ISA Bus Expansion Slots* |
| 4) PCI1, PCI2, PCI3 | p. 22 32-bit PCI Bus Expansion Slots |
| 5) AGP | p. 22 Accelerated Graphics Port |

Connectors

- | | |
|-------------------------|---|
| 1) PS2KBMS | p. 23 PS/2 Mouse Connector (6-pin female) |
| 2) PS2KBMS | p. 23 PS/2 Keyboard Connector (6-pin female) |
| 3) USB | p. 24 Universal Serial BUS Ports 1 & 2 (Two 4-pin female) |
| 4) PRINTER | p. 24 Parallel Port Connector (25-pin female) |
| 5) COM1, COM2 | p. 24 Serial Port COM1 and COM2 Connectors (9-pin male) |
| 6) GAME_AUDIO | p. 25 Joystick/Midi Connector (15-pin female) (optional) |
| 7) GAME_AUDIO | p. 25 Audio Port Connectors (Three 1/8" female) (optional) |
| 8) ATXPWR | p. 25 ATX Power Supply Connector (20 pins) |
| 9) IDE1, IDE2 | p. 26 Primary/Secondary IDE Connectors (Two 40-1pins) |
| 10) FLOPPY | p. 26 Floppy Disk Drive Connector (34-1pins) |
| 11) CHA_, CPU_, PWR_FAN | p. 27 Chassis, CPU, Power Supply Fan Connectors (Three 3-pin) |
| 12) WOL_CON | p. 27 Wake-On-LAN Header (3 pins) |
| 13) WOR | p. 28 Wake-On-Ring Header (2 pins) |
| 14) IR | p. 28 IrDA-Compliant Infrared Module Connector (5 pins) |
| 15) IDELED | p. 29 IDE LED Activity Light (2 pins) |
| 16) SBLINK | p. 29 SB-Link™ Connector (6-1 pins) |
| 17) CHASIS | p. 30 Chassis Intrusion Sensor Lead (4-1 pins) |
| 18) SMB | p. 30 SMBus Connector (5-1 pins) |
| 19) AUX/CD1 | p. 31 Stereo Audio In Connectors (Two 4-pin) |
| 20) CD2 | p. 31 Stereo Audio In Connector (4 pins) |
| 21) MODEM | p. 32 Modem Card Voice In Connector (4 pins) |
| 22) MSG.LED (PANEL) | p. 32 System Message LED (2 pins) |
| 23) SMI (PANEL) | p. 33 SMI Switch Lead (2 pins) |
| 24) PWR.SW (PANEL) | p. 33 ATX Power & Soft-Off Switch Lead (2 pins) |
| 25) RESET (PANEL) | p. 33 Reset Switch Lead (2 pins) |
| 26) PWR.LED (PANEL) | p. 33 System Power LED Lead (3-1 pins) |
| 27) KEYLOCK (PANEL) | p. 33 Keyboard Lock Switch Lead (2 pins) |
| 28) SPEAKER (PANEL) | p. 33 System Warning Speaker Connector (4 pins) |

*The onboard hardware monitor uses the address 290H-297H so legacy ISA cards must not use this address; otherwise, conflicts will occur.

III. HARDWARE SETUP

Hardware Setup Steps

Before using your computer, you must complete the following steps:

1. Make Motherboard Settings
2. Install System Memory Modules
3. Install the Central Processing Unit (CPU)
4. Install Expansion Cards
5. Connect Ribbon Cables, Cabinet Wires, and Power Supply
6. Setup the BIOS Software

1. Motherboard Settings

WARNING! Computer motherboards, baseboards and components, such as SCSI cards, contain very delicate Integrated Circuit (IC) chips. To protect them against damage from static electricity, you should follow some precautions whenever you work on your computer.

1. Unplug your computer when working on the inside.
2. Use a grounded wrist strap before handling computer components. If you do not have one, touch both of your hands to a safely grounded object or to a metal object, such as the power supply case.
3. Hold components by the edges and try not to touch the IC chips, leads or connectors, or other components.
4. Place components on a grounded antistatic pad or on the bag that came with the component whenever the components are separated from the system.

1. Keyboard Power Up (3-pin KBPWRUP)

This allows you to disable or enable the keyboard power up function. Set this jumper to *Enable* if you wish to use your keyboard (by pressing the spacebar) to power up your computer. This feature requires an ATX power supply that can supply at least 300mA on the +5VSB lead. The default is set to *Disable* because not all computers have the appropriate ATX power supply. Your computer will not power on if you set this to *Enable* and if you do not have the right ATX power supply.

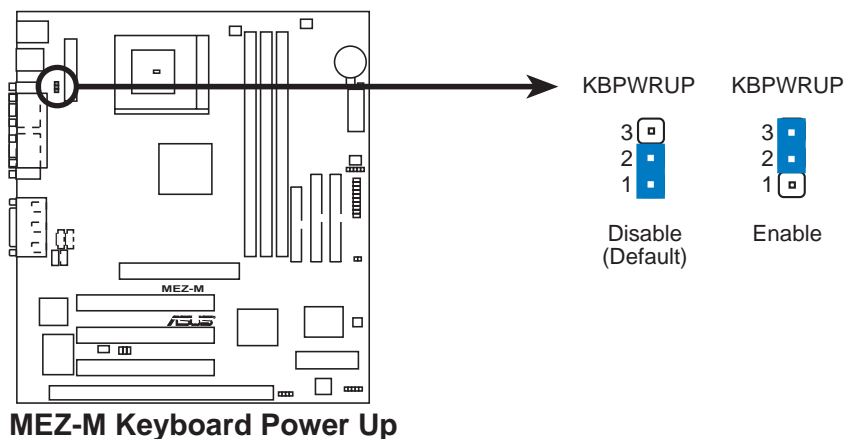

III. HARDWARE SETUP

Motherboard Feature Settings (DIP Switches)

The motherboard's onboard features can be adjusted through the DIP switches. The white block represents the switch's position. The example below shows all the switches in the OFF position.

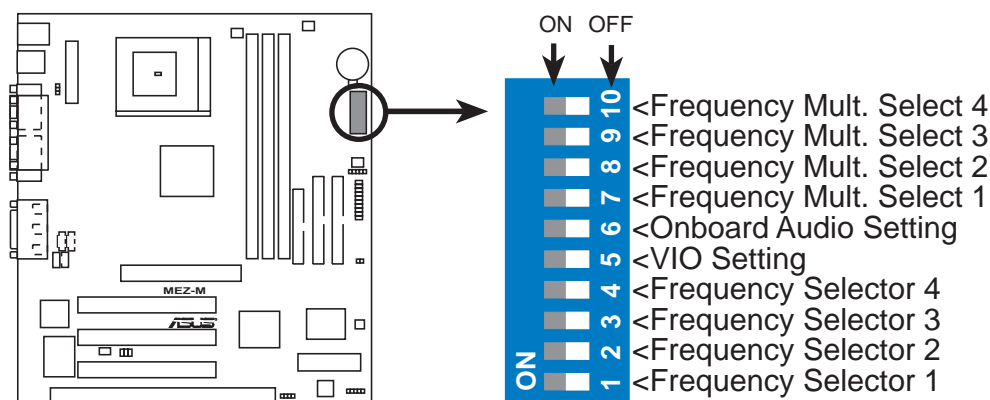

MEZ-M DIP Switch

2. VIO Setting (DIP5)

The onboard voltage regulator allows you to select the voltage supplied to the DRAM, chipset, AGP, and the CPU's I/O buffer. **IMPORTANT!** Setting this DIP switch to *ON* (High Voltage) may reduce system life. It is strongly recommended that you leave this DIP switch on its default setting of *OFF* (Normal).

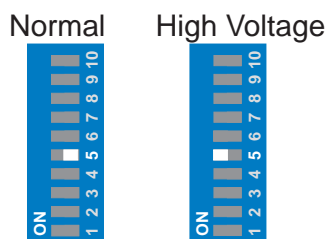

MEZ-M VIO

3. Onboard Audio Setting (DIP6)

The onboard audio can be turned ON or OFF using this DIP switch.

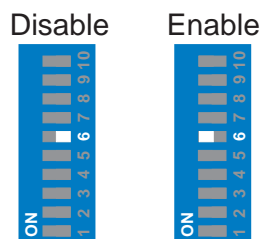

MEZ-M Onboard Audio

III. HARDWARE SETUP

4. CPU External (BUS) Frequency Selection (DIP1, 2, 3, 4)

These DIP switches tell the clock generator what frequency to send to the CPU. These allow the selection of the CPU's *External* frequency (or *BUS Clock*). The *BUS Clock* times the *BUS Ratio* equals the CPU's *Internal* frequency (the advertised CPU speed).

CPU → 66.8MHz
PCI → 33.4MHz



MEZ-M CPU External Clock (BUS) Frequency Selection

5. CPU to BUS Frequency Multiple (DIP7, 8, 9, 10)

These DIP switches set the frequency multiple between the *Internal* frequency of the CPU and the *External* frequency (called the *BUS Clock*) within the CPU.

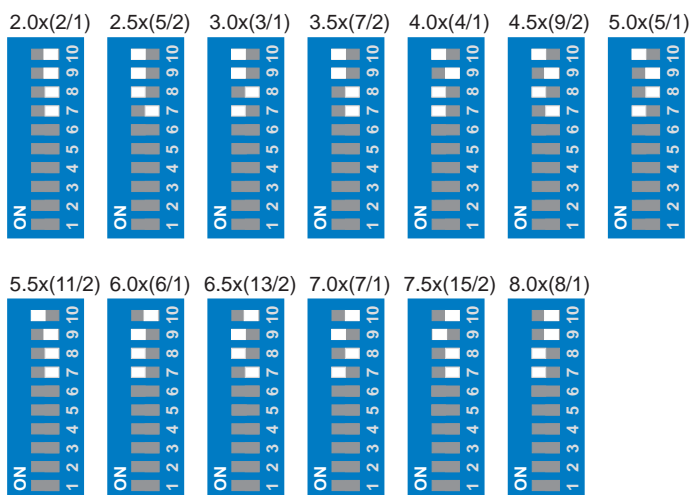

MEZ-M CPU : BUS Frequency Multiple

Set the DIP switches by the Internal speed of your processor as follows:

Intel CPU Model	Speed	Mult	Freq.	(BUS Frequency)				(Frequency Multiple)			
				DIP1	DIP2	DIP3	DIP4	DIP7	DIP8	DIP9	DIP10
Celeron (PPGA)	400MHz	6.0x	66MHz	[OFF]	[OFF]	[ON]	[ON]	[ON]	[ON]	[ON]	[OFF]
Celeron (PPGA)	366MHz	5.5x	66MHz	[OFF]	[OFF]	[ON]	[ON]	[OFF]	[OFF]	[OFF]	[ON]
Celeron (PPGA)	333MHz	5.0x	66MHz	[OFF]	[OFF]	[ON]	[ON]	[ON]	[OFF]	[OFF]	[ON]
Celeron (PPGA)	300MHz	4.5x	66MHz	[OFF]	[OFF]	[ON]	[ON]	[OFF]	[ON]	[OFF]	[ON]

III. HARDWARE SETUP

2. System Memory (DIMM)

NOTE: No hardware or BIOS setup is required after adding or removing memory.

This motherboard uses only Dual Inline Memory Modules (DIMMs). Sockets are available for **3.3Volt** (power level) unbuffered Synchronous Dynamic Random Access Memory (SDRAM) of either 8, 16, 32, 64, 128MB, or 256MB.

The Intel 440ZX AGPset does not support ECC function. ECC memory modules may be used but the ECC function will not be available.

Memory speed setup is recommended through *SDRAM Configuration* under “Chipset Features Setup” in BIOS SETUP.

Install memory in the following combinations:

Location	168-pin DIMM SDRAM		Total Memory
Socket 1 (Rows 0&1)	Single-sided Double-sided	x1	
Socket 2 (Rows 2&3)	Single-sided Double-sided (Socket 3 must be empty)	x1	
Socket 3 (Row 3)	Single-sided (Socket 2 must be single-sided) (Double-sided cannot be used here!)	x1	
	Total System Memory (Max 256MB)	=	

IMPORTANT! A total of four rows of memory is supported on this motherboard. One side (with memory chips) of the DIMM takes up one row. Because Socket 3 shares Row 3 with Socket 2, Socket 3 can only be used if Socket 2 does not use Row 3.

WARNING! If Row 3 is used by both Socket 2 and 3, your system will not boot up!

SPD Support

This motherboard supports SPD DIMMs, and it is recommended that SPD DIMMs be used.

General DIMM Notes

- **For the system CPU bus to operate above 100MHz, use only PC100-compliant DIMMs.** When this motherboard operates at 100MHz, most system will not even boot if non-compliant modules are used because of the strict timing issues involved under this speed. If your DIMMs are not PC100-compliant, set the CPU bus frequency to 66MHz for system stability.
- Two possible memory chips are supported: SDRAM with and without ECC.
- SDRAM chips are generally thinner with higher pin density than EDO (Extended Data Output) chips.
- BIOS shows SDRAM memory on bootup screen.
- 8 chips/side modules do not support ECC, only 9 chips/side modules support ECC.
- Single-sided DIMMs come in 16, 32, 64, 128MB; double-sided come in 32, 64, 128, 256MB.

III. HARDWARE SETUP

DIMM Memory Installation

Insert the module(s) as shown. Because the number of pins are different on either side of the breaks, the module will only fit in the orientation as shown. DIMM modules are longer and have different pin contact on each side and therefore have a higher pin density. SIMM modules have the same pin contact on both sides.

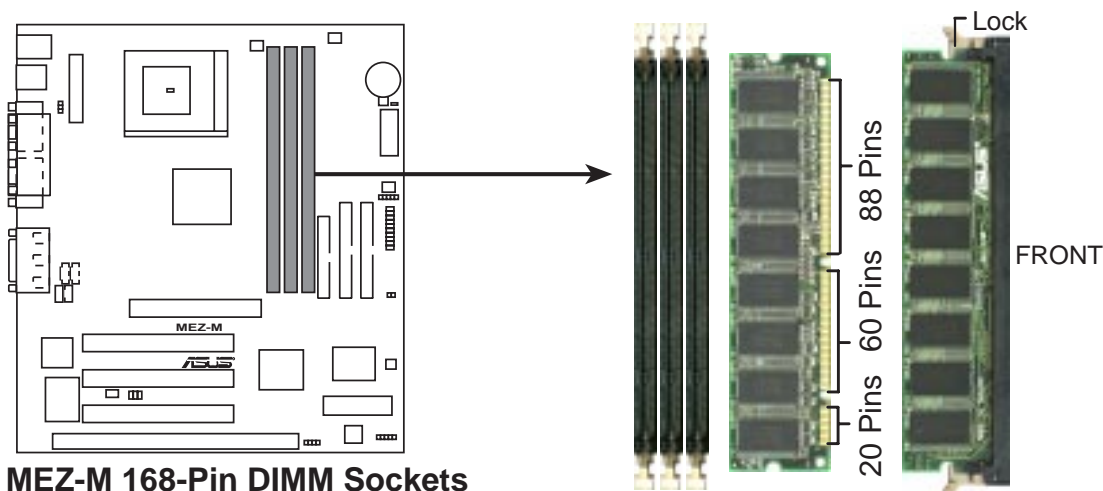

MEZ-M 168-Pin DIMM Sockets

The DIMMs must be **3.3V Unbuffered** for this motherboard. To determine the DIMM type, check the notches on the DIMMs (see figure below).

168-Pin DIMM Notch Key Definitions (3.3V)

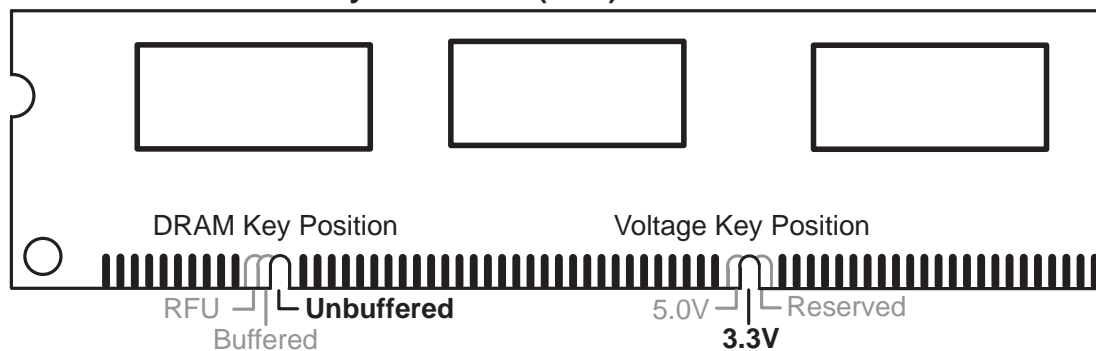

The notches on the DIMM module will shift between left, center, or right to identify the type and also to prevent the wrong type from being inserted into the DIMM slot on the motherboard. You must ask your retailer the correct DIMM type before purchasing. This motherboard supports four clock signals.

III. HARDWARE SETUP

3. Central Processing Unit (CPU)

The motherboard provides a ZIF Socket 370. The CPU that came with the motherboard should have a fan attached to it to prevent overheating. If this is not the case then purchase a fan before you turn on your system.

WARNING! Be sure that there is sufficient air circulation across the processor's heatsink by regularly checking that your CPU fan is working. Without sufficient circulation, the processor could overheat and damage both the processor and the motherboard. You may install an auxiliary fan, if necessary.

To install a CPU, first turn off your system and remove its cover. Locate the ZIF socket and open it by first pulling the lever sideways away from the socket then upwards to a 90-degree right angle. Insert the CPU with the correct orientation as shown. The notched corner should point towards the end of the lever. Because the CPU has a corner pin for two of the four corners, the CPU will only fit in the one orientation as shown. The picture is for reference only; you should have a CPU fan that will cover the face of the CPU. With the added weight of the CPU fan, no force is required to insert the CPU. Once completely inserted, close the socket's lever while holding down the CPU.

NOTE: Set the bus frequency and multiple for your Socket 370 processor.

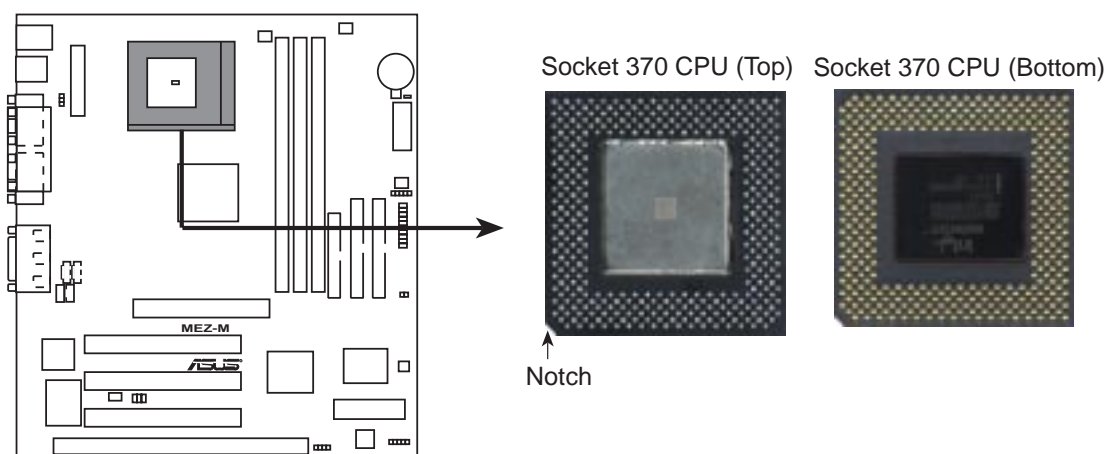

MEZ-M Socket 370

III. HARDWARE SETUP

(This page was intentionally left blank.)

III. HARDWARE SETUP

4. Expansion Cards

WARNING! Make sure that you unplug your power supply when adding or removing expansion cards or other system components. Failure to do so may cause severe damage to both your motherboard and expansion cards.

Expansion Card Installation Procedure

1. Read the documentation for your expansion card and make any necessary hardware or software settings for your expansion card, such as jumpers.
2. Remove your computer system's cover and the bracket plate on the slot you intend to use. Keep the bracket for possible future use.
3. Carefully align the card's connectors and press firmly.
4. Secure the card on the slot with the screw you removed above.
5. Replace the computer system's cover.
6. Set up the BIOS if necessary
(such as *IRQ xx Used By ISA: Yes* in PNP AND PCI SETUP)
7. Install the necessary software drivers for your expansion card.

Assigning IRQs for Expansion Cards

Some expansion cards need to use an IRQ to operate. Generally, an IRQ must be exclusively assigned to one use. In a standard design, there are 16 IRQs available but most of them are already in use, leaving 6 IRQs free for expansion cards. If your motherboard has PCI audio onboard, an extra IRQ will be used, leaving 5 IRQs free. If your motherboard has ISA audio onboard, an extra 3 IRQs will be used, leaving 3 IRQs free.

Both ISA and PCI expansion cards may require to use IRQs. System IRQs are available to cards installed in the ISA expansion bus first, then any remaining IRQs are available to PCI cards. Currently, there are two types of ISA cards. The original ISA expansion card design, now referred to as legacy ISA cards, requires that you configure the card's jumpers manually and then install it in any available slot on the ISA bus. You may use the Microsoft Diagnostics (MSD.EXE) utility located in the Windows directory to see a map of your used and free IRQs. If you use Windows 95, the **Resources** tab under **Device Manager** displays the resource settings being used by a particular device (to gain access, double-click the **System** icon under the **Control Panel** program). Ensure that no two devices share the same IRQs or your computer will experience problems when those two devices are in use at the same time.

III. HARDWARE SETUP

To simplify this process this motherboard has complied with the Plug and Play (PNP) specification which was developed to allow automatic system configuration whenever a PNP-compliant card is added to the system. For PNP cards, IRQs are assigned automatically from those available.

If the system has both Legacy and PNP ISA cards installed, IRQs are assigned to PNP cards from those not used by Legacy cards. The PCI and PNP configuration of the BIOS setup utility can be used to indicate which IRQs are being used by Legacy cards. For older Legacy cards that does not work with the BIOS, you can contact your vendor for an ISA Configuration Utility.

An IRQ number is automatically assigned to PCI expansion cards after those used by Legacy and PNP ISA cards. In the PCI bus design, the BIOS automatically assigns an IRQ to a PCI slot that has a card in it that requires an IRQ. To install a PCI card, you need to set something called the INT (interrupt) assignment. Since all the PCI slots on this motherboard use an INTA #, be sure that the jumpers on your PCI cards are set to INT A.

Assigning DMA Channels for ISA Cards

Some ISA cards, both legacy and PnP, may also need to use a DMA (Direct Memory Access) channel. DMA assignments for this motherboard are handled the same way as the IRQ assignment process described earlier. You can select a DMA channel in the PCI and PnP configuration section of the BIOS Setup utility.

NOTE: The onboard audio by default uses DMA1.

IMPORTANT: To avoid conflicts, reserve the necessary IRQs and DMAs for legacy ISA cards (under PNP AND PCI SETUP of BIOS SETUP, choose *Yes* in *IRQ_{xx} Used By ISA* and *DMA_x Used By ISA* for those IRQs and DMAs you want to reserve).

ISA Cards and Hardware Monitor

The onboard hardware monitor uses the address 290H-297H so legacy ISA cards must not use this address or else conflicts will occur.

Accelerated Graphics Port

This motherboard provides an accelerated graphics port (AGP) slot to support a new generation of graphics cards with ultra-high memory bandwidth, such as an ASUS 3D hardware accelerator.

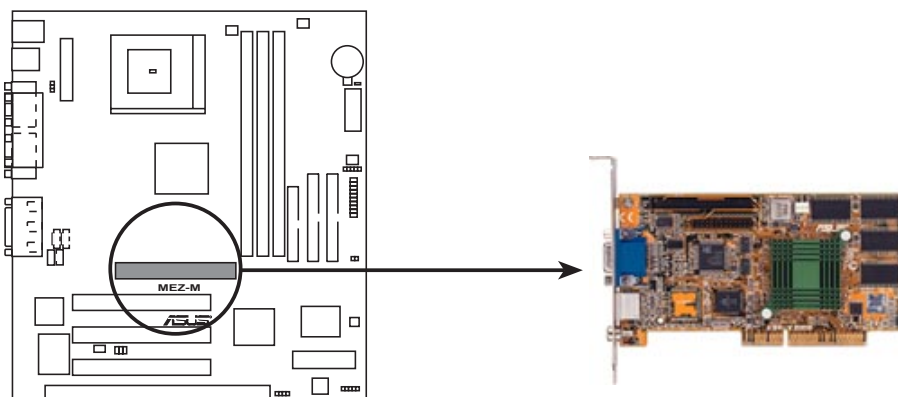

MEZ-M Accelerated Graphics Port (AGP)

III. HARDWARE SETUP

5. External Connectors

WARNING! Some pins are used for connectors or power sources. These are clearly distinguished from jumpers in the Motherboard Layout. Placing jumper caps over these connector pins will cause damage to your motherboard.

IMPORTANT: Ribbon cables should always be connected with the red stripe on the Pin 1 side of the connector. The four corners of the connectors are labeled on the motherboard. Pin 1 is the side closest to the power connector on hard drives and floppy drives. IDE ribbon cable must be less than 46 cm (18 in.), with the second drive connector no more than 15 cm (6 in.) from the first connector.

1. PS/2 Mouse Connector (6-pin PS2KBMS)

The system will direct IRQ12 to the PS/2 mouse if one is detected. If not detected, expansion cards can use IRQ12. See “PS/2 Mouse Control” in *BIOS Features Setup* of the BIOS SETUP.

PS/2 Mouse (6-pin Female)

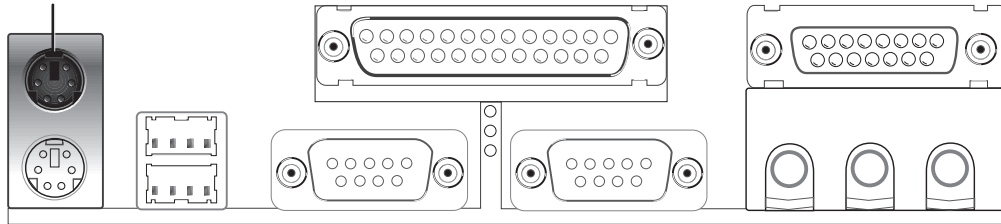

2. PS/2 Keyboard Connector (6-pin PS2KBMS)

This connection is for a standard keyboard using an PS/2 plug (mini DIN). **This connector will not allow standard AT size (large DIN) keyboard plugs. You may use a DIN to mini DIN adapter on standard AT keyboards.**

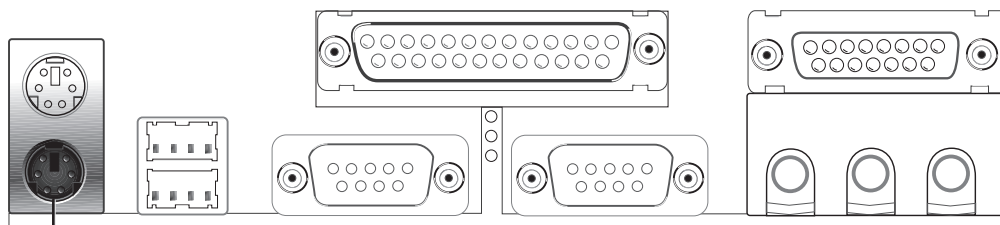

PS/2 Keyboard (6-pin Female)

III. HARDWARE SETUP

3. Universal Serial BUS Ports 1 & 2 (Two 4-pin USB)

Two USB ports are available for connecting USB devices.

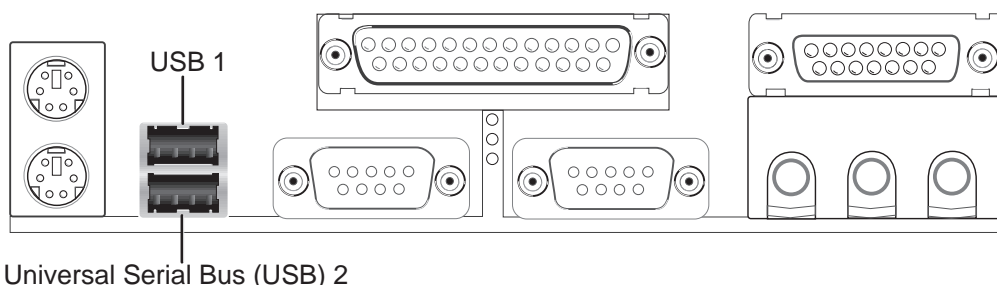

4. Parallel Port Connector (25-pin PRINTER)

You can enable the parallel port and choose the IRQ through “Onboard Parallel Port” in *Chipset Features Setup* of BIOS SETUP.

NOTE: Serial printers must be connected to the serial port.

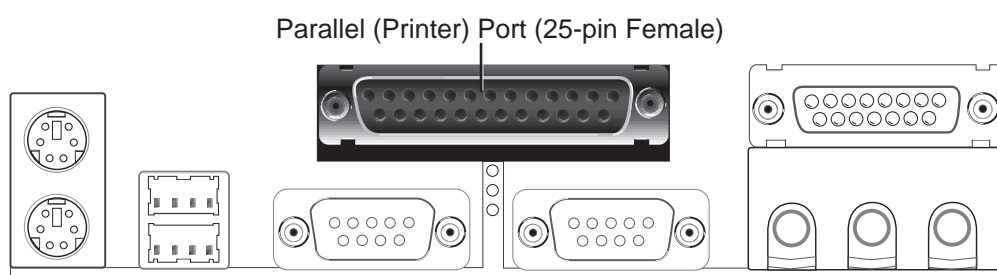

5. Serial Port Connectors (Two 9-pin COM1/COM2)

The two serial ports can be used for pointing devices or other serial devices. See “Onboard Serial Port” in *Chipset Features Setup* of BIOS SETUP.

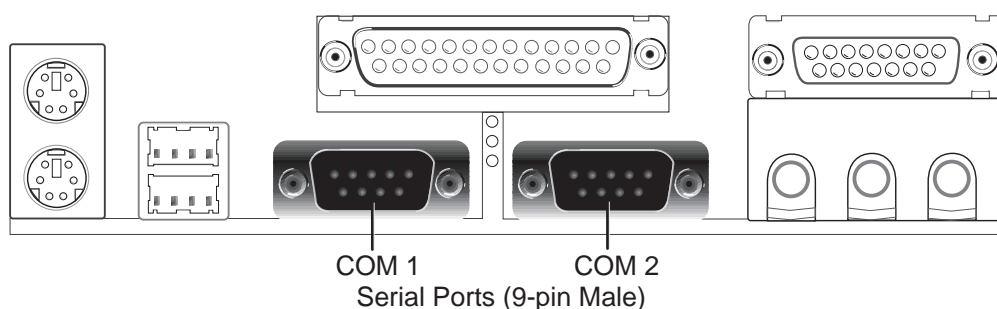

III. HARDWARE SETUP

6. Joystick/Midi Connector (15-pin GAME_AUDIO)

You may connect game joysticks or game pads to this connector for playing games. Connect MIDI devices for playing or editing audio.

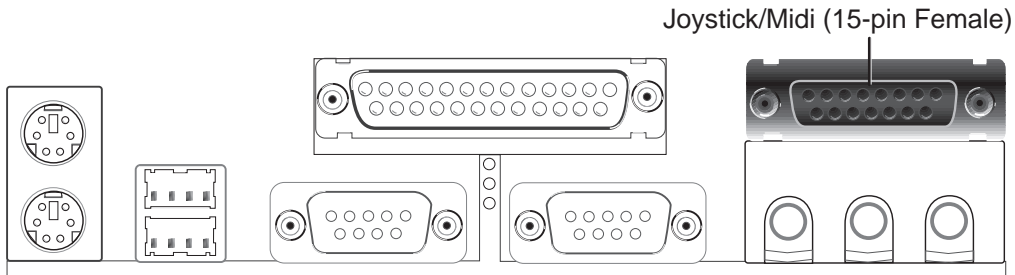

7. Audio Port Connectors (Three 1/8" GAME_AUDIO)

Line Out can be connected to headphones or preferably powered speakers. **Line In** allows tape players or other audio sources to be recorded by your computer or played through the **Line Out**. **Mic** allows microphones to be connected for inputting voice.

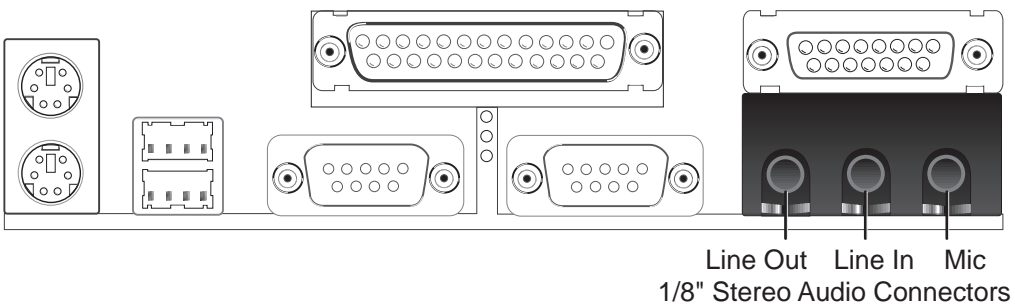

8. ATX Power Supply Connector (20-pin block ATXPWR)

This connector connects to an ATX power supply. The plug from the power supply will only insert in one orientation because of the different hole sizes. Find the proper orientation and push down firmly making sure that the pins are aligned.

IMPORTANT: Make sure that your ATX power supply can supply at least 10mA on the +5-volt standby lead (+5VSB). You may experience difficulty in powering on your system if your power supply cannot support the load. For Wake-On-LAN support, your ATX power supply must supply at least 720mA +5VSB.

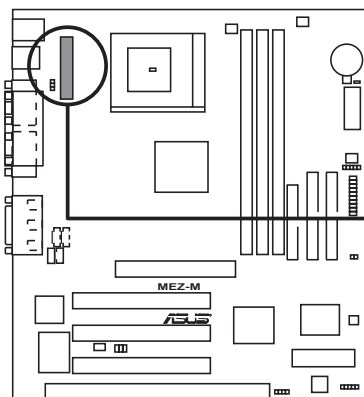

MEZ-M ATX Power Connector

+3.3Volts		+3.3 Volts
-12.0Volts		+3.3 Volts
Ground		Ground
Power Supply On		+5.0 Volts
Ground		Ground
Ground		+5.0 Volts
Ground		Ground
-5.0 Volts		Power Good
+5.0 Volts		+5V Standby
+5.0 Volts		+12.0Volts

III. HARDWARE SETUP

9. Primary / Secondary IDE Connectors (Two 40-1pin IDE)

These connectors support the provided IDE hard disk ribbon cable. After connecting the single end to the board, connect the two plugs at the other end to your hard disk(s). If you install two hard disks, you must configure the second drive to Slave mode by setting its jumper accordingly. Please refer to the documentation of your hard disk for the jumper settings. BIOS now supports SCSI device or IDE CD-ROM bootup (see “HDD Sequence SCSI/IDE First” & “Boot Sequence” in *BIOS Features Setup* of BIOS SETUP) **(Pin 20 is removed to prevent inserting in the wrong orientation when using ribbon cables with pin 20 plugged).**

TIP: You may configure two hard disks to be both Masters using one ribbon cable on the primary IDE connector and another ribbon cable on the secondary IDE connector. You may install one operating system on an IDE drive and another on a SCSI drive and select the boot disk through BIOS Features Setup.

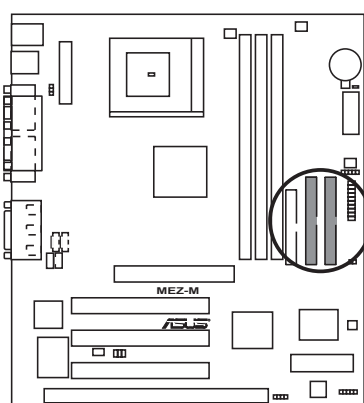

MEZ-M IDE Connectors

NOTE: Orient the red markings (usually zigzag) on the IDE ribbon cable to PIN 1

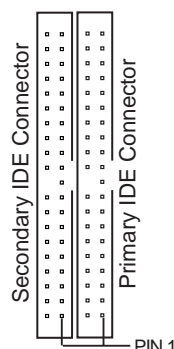

10. Floppy Disk Drive Connector (34-1pin FLOPPY)

This connector supports the provided floppy drive ribbon cable. After connecting the single end to the board, connect the two plugs on the other end to the floppy drives. **(Pin 5 is removed to prevent inserting in the wrong orientation when using ribbon cables with pin 5 plugged).**

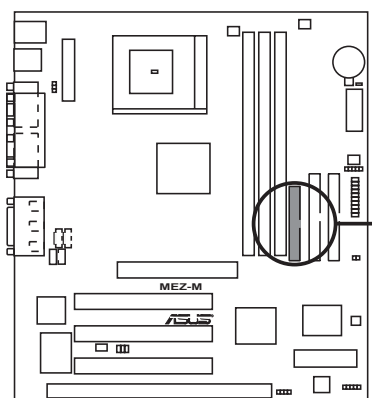

MEZ-M Floppy Disk Drive Connector

NOTE: Orient the red markings on the floppy ribbon cable to PIN 1

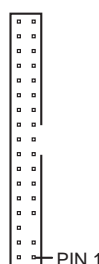

III. HARDWARE SETUP

11. Chassis, CPU, & Power Supply Fan Connectors (3-pin CHA_, CPU_, PWR_FAN)

These connectors support cooling fans of 500mAMP (6 Watts) or less. Orientate the fans so that the heat sink fins allow airflow to go across the onboard heat sink(s) instead of the expansion slots. Depending on the fan manufacturer, the wiring and plug may be different. The red wire should be positive, while the black should be ground. Connect the fan's plug to the board taking into consideration the polarity of the this connector. **NOTE: The "Rotation" signal is to be used only by a specially designed fan with rotation signal.**

WARNING! The CPU and/or motherboard will overheat if there is no airflow across the CPU and onboard heatsinks. Damage may occur to the motherboard and/or the CPU fan if these pins are incorrectly used. **These are not jumpers, do not place jumper caps over these pins.**

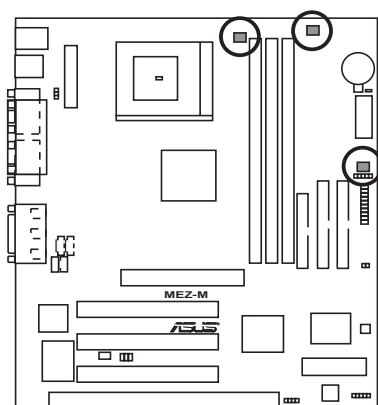

CPU Fan Power
Power Supply Fan
Chassis Fan Power

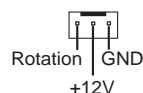

MEZ-M 12-Volt Cooling Fan Power

12. Wake-On-LAN Connector (3-pin WOL_CON)

This connector connects to LAN cards with a Wake-On-LAN output, such as the ASUS PCI-L101 (see section on **ASUS LAN Card**). The connector powers up the system when a wakeup packet or signal is received through the LAN card.

IMPORTANT: This feature requires that the **WAKE On LAN Power Up Control** is set to *Enabled* (see "Power Management Setup" under **BIOS SETUP**) and that your system has an ATX power supply with at least 720mA +5V standby power.

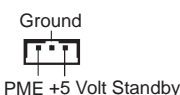
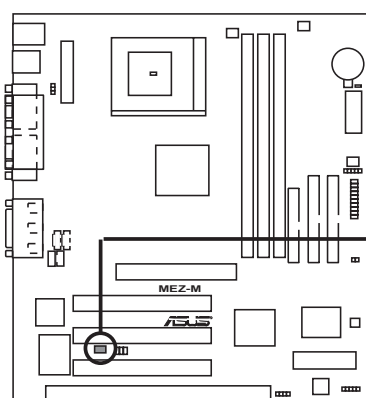

IMPORTANT: Requires an ATX power supply with at least 720mA +5-volt standby power

MEZ-M Wake-On-LAN Connector

III. HARDWARE SETUP

13. Wake-On-Ring Header (2-pin WOR)

This connector connects to internal modem cards with a Wake-On-Ring output. The connector powers up the system when a ringup packet or signal is received through the internal modem card. **NOTE:** For external modems, Wake-On-Ring is detected through the COM port.

IMPORTANT: This feature requires that the **PWR UP On Modem Act Power Up Control** is set to *Enabled* (see *Power Management Setup* under BIOS SETUP) and that your system has an ATX power supply with at least 720mA +5V standby power.

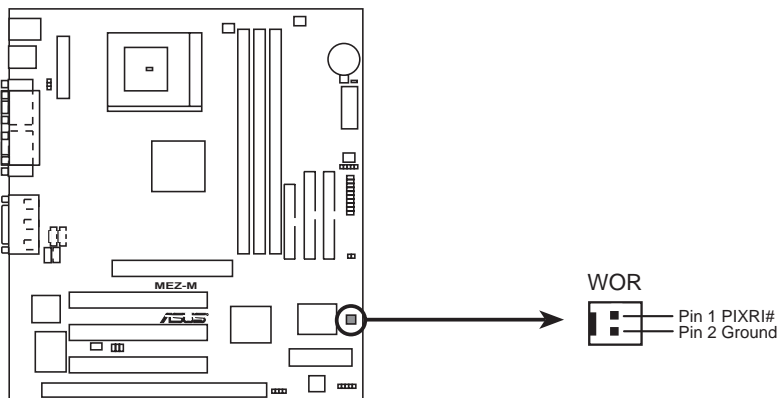

MEZ-M Wake-On-Ring Header

14. IrDA-Compliant infrared module connector (5-pin IR)

This connector supports the optional wireless transmitting and receiving infrared module. This module mounts to a small opening on system cases that support this feature. You must also configure the setting through “UART2 Use Infrared” in *Chipset Features Setup* to select whether UART2 is directed for use with COM2 or IrDA. Use the five pins as shown on the Back View and connect a ribbon cable from the module to the motherboard according to the pin definitions.

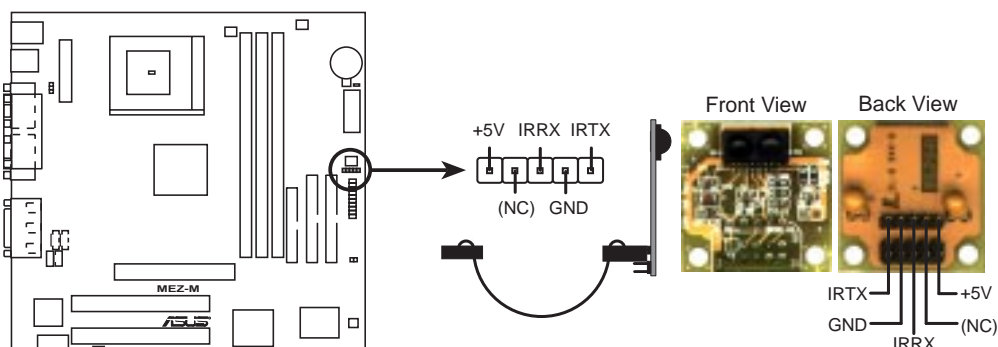

MEZ-M Infrared Module Connector

III. HARDWARE SETUP

15. IDE Device Activity LED (2-pin IDELED)

This connector supplies power to the cabinet's hard disk or IDE activity LED. Read and write activity by devices connected to the Primary or Secondary IDE connectors will cause the LED to light up.

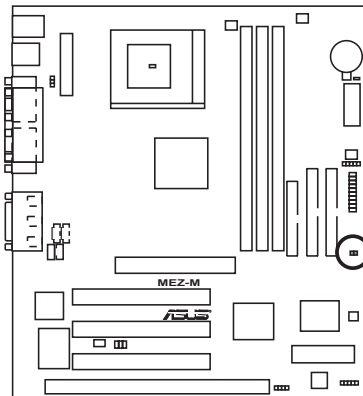

TIP: If the case-mounted LED does not light, try reversing the 2-pin plug.



MEZ-M IDE Activity LED

16. SB-Link™ Connector (6-1 pin SBLINK)

If you have a Sound Blaster compatible PCI audio card, you must link it to this connector. Otherwise, you will have compatibility issues under DOS environment.

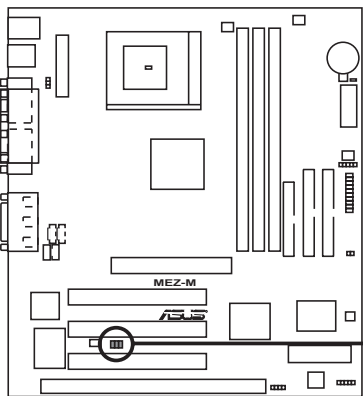

NOTE: Pin 3 is removed to ensure the correct orientation of the cable on it.

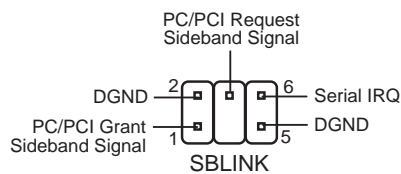

MEZ-M SB-Link™ Header

III. HARDWARE SETUP

17. Chassis Intrusion Sensor Lead (4-1 pin CHASIS)

This lead is for a chassis intrusion monitor or sensor. The sensor is triggered when a high level signal is sent to the “chassis signal” lead. This occurs when a panel switch or light detector is triggered. This function requires optional trigger switches to be installed.

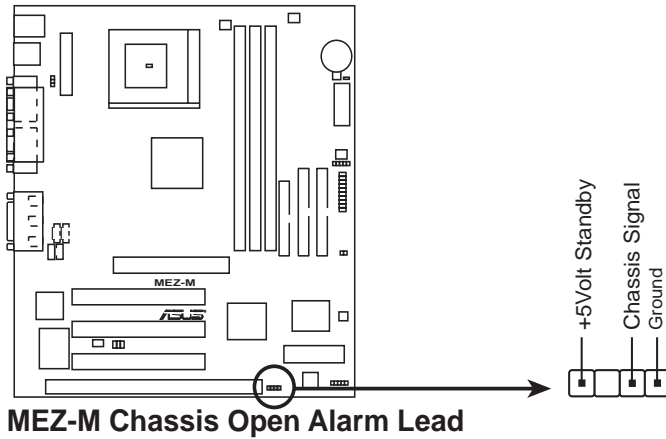

18. SMBus Connector (5-1 pin SMB)

This connector allows you to connect SMBus devices. SMBus devices communicate by means of the SMBus with an SMBus host and/or other SMBus devices. The SMBus or System Management Bus is a specific implementation of an I²C bus, which is a multi-master bus, that is, multiple chips can be connected to the same bus and each one can act as a master by initiating data transfer.

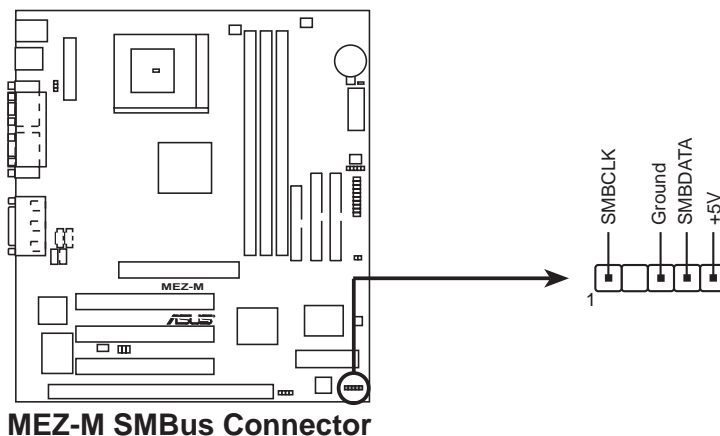

III. HARDWARE SETUP

19. Stereo Audio In Connectors (4-pin AUX, CD1)

These connectors allow you to receive stereo audio input from such sound sources as a TV tuner or MPEG card.

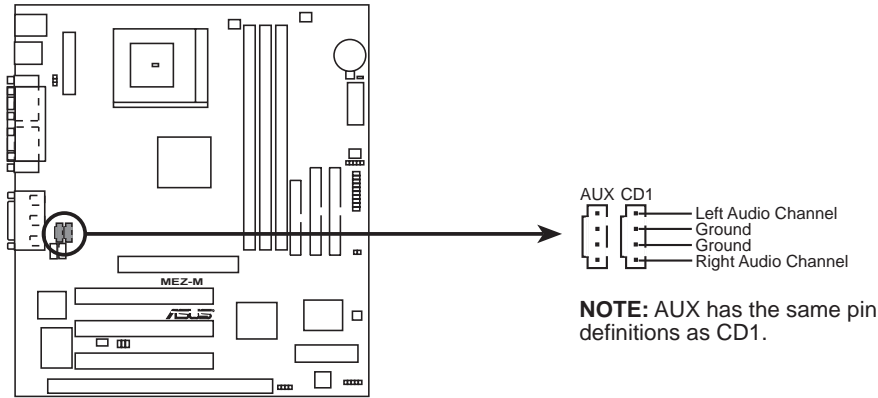

MEZ-M Stereo Audio In Connectors

20. Stereo Audio In Connector (4-pin CD2)

This connector allows you to receive stereo audio input from an internal CD-ROM drive or other sound sources such as a TV tuner or MPEG card. .

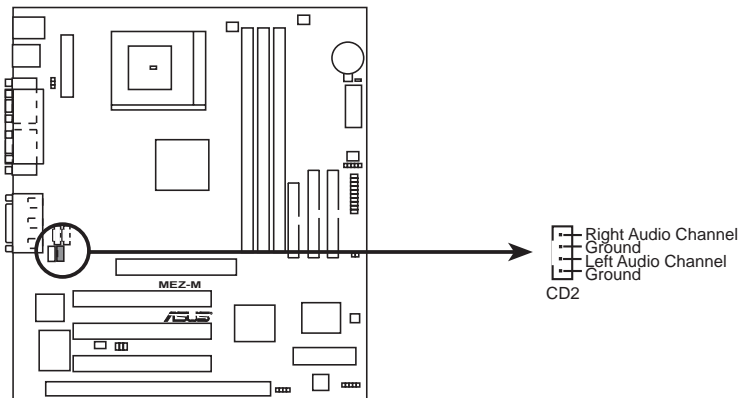

MEZ-M Stereo Audio In Connector

III. HARDWARE SETUP

21. Voice Modem In Connector (4-pin MODEM)

This connector allows the onboard audio to interface with a voice modem card. It also allows the sharing of microphone and speaker between the onboard audio and the voice modem card. **NOTE:** Your voice modem card requires a similar connector to use this feature.

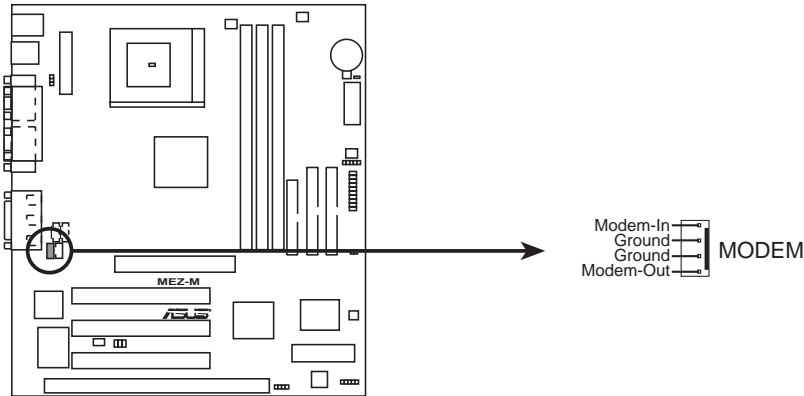

MEZ-M Modem Card Voice In Connector

For Items 22-28

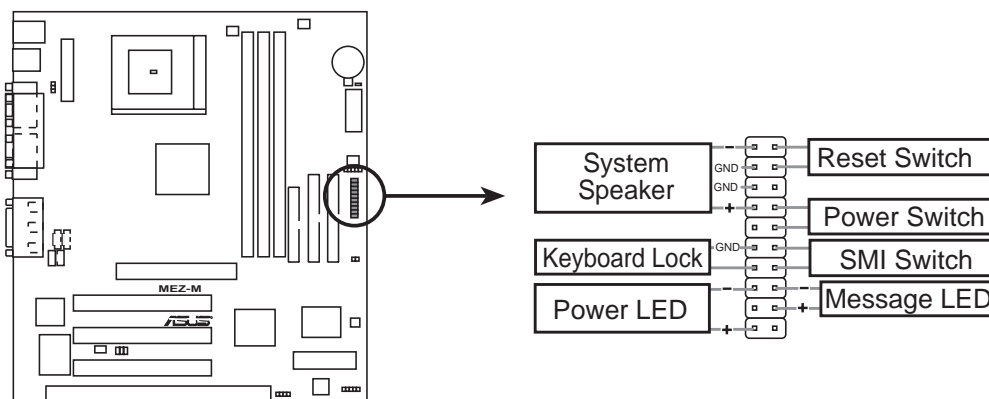

MEZ-M System Panel Connectors

22. Message LED Lead (2-pin MSG.LED)

This indicates whether a message has been received from a fax/modem. The LED will remain lit when there is no signal and blink when there is data transfer or waiting in the inbox. This function requires ACPI OS and driver support.

III. HARDWARE SETUP

23. System Management Interrupt Lead (2-pin SMI)

This allows the user to manually place the system into a suspend mode or “Green” mode where system activity is decreased to save electricity and expand the life of certain components when the system is not in use. This 2-pin connector connects to the case-mounted suspend switch. If you do not have a switch for the connector, you may use the “Turbo Switch”. SMI is activated when it detects a *short to open* moment and therefore leaving it shorted will not cause any problems. This may require one or two presses depending on the position of the switch. Wake-up can be controlled by settings in the BIOS but the keyboard will always allow wake-up (the SMI lead cannot wake up the system). If you want to use this connector, set “Suspend Mode” under *Power Management Setup* of BIOS SETUP section to the preferred time after which the system must go into suspend mode when you press the switch.

24. ATX Power Switch / Soft Power Switch (2-pin PWR.SW)

The system power is controlled by a momentary switch connected to this lead. Pressing the button once will switch the system between ON and SLEEP or ON and SOFT OFF depending on the “PWR Button” setting under *Power Management Setup* of BIOS SETUP section. Pressing the switch while in the ON mode for more than 4 seconds will turn the system off. The system power LED shows the status of the system’s power.

25. Reset Switch Lead (2-pin RESET)

This 2-pin connector connects to the case-mounted reset switch for rebooting your computer without having to turn off your power switch. This is a preferred method of rebooting to prolong the life of the system’s power supply.

26. System Power LED (3-1 pin PWR.LED)

This 3-1 pin connector connects the system power LED, which lights when the system is powered on and blinks when it is in sleep mode.

27. Keyboard Lock Switch Lead (2-pin KEYLOCK)

This 2-pin connector connects to the case-mounted key switch to allow keyboard locking.

28. System Warning Speaker Connector (4-pin SPEAKER)

This 4-pin connector connects to the case-mounted speaker. You may leave this disconnect as this motherboard has an onboard buzzer which can replace the chassis speaker. When connected, you will hear system warnings through both sources.

NOTE: Some sound cards allow you to connect to the system speaker signal so that the warnings can be heard and adjusted through your multimedia system.

III. HARDWARE SETUP

(This page was intentionally left blank.)

III. HARDWARE SETUP

Power Connection Procedures

1. After all connections are made, close the system case cover.
 2. Be sure that all switches are off (in some systems, marked with ○).
 3. Connect the power supply cord into the power supply located on the back of your system case according to your system user's manual.
 4. Connect the power cord into a power outlet that is equipped with a surge protector.
 5. You may then turn on your devices in the following order:
 - a. Your monitor
 - b. External SCSI devices (starting with the last device on the chain)
 - c. Your system power. For ATX power supplies, you need to switch on the power supply if a switch is provided as well as press the ATX power switch on the front of the case.
 6. The power LED on the front panel of the system case will light. For ATX power supplies, the system LED will light when the ATX power switch is pressed. The LED on the monitor may light up or switch between orange and green after the system's if it complies with "green" standards or if it has a power standby feature. The system will then run power-on tests. While the tests are running, additional messages will appear on the screen. If you do not see anything within 30 seconds from the time you turn on the power, the system may have failed a power-on test. Recheck your jumper settings and connections or call your retailer for assistance.
 7. During power-on, hold down <Delete> to enter BIOS setup. Follow the instructions in the next section, BIOS SETUP.
- * **Powering Off your computer:** You must first exit or shut down your operating system before switching off the power switch. For ATX power supplies, you can press the ATX power switch after exiting or shutting down your operating system. If you use Windows 95/98, click the **Start** button, click **Shut Down**, and then click **Shut down the computer?**. The power supply should turn off after Windows shuts down.

NOTE: The message "You can now safely turn off your computer" will not appear when shutting down with ATX power supplies.

IV. BIOS SETUP

Flash Memory Writer Utility

AFLASH.EXE: This is the Flash Memory Writer utility that updates the BIOS by uploading a new BIOS file to the programmable flash ROM chip on the motherboard. To determine the BIOS version of your motherboard, check the last four numbers of the code displayed on the upper left-hand corner of your screen during bootup. Larger numbers represent a newer BIOS file. This file works only in DOS mode.

NOTE: The following screen displays are provided as examples only and may not reflect the screen contents displayed on your system.

```
          ACPI BIOS
    FLASH MEMORY WRITER V1.0
    Copyright (C) 1994-99, ASUSTeK COMPUTER INC.

Flash Memory: 32T 256K09

Current BIOS Version: 6015      ACPI BIOS Revision 1001
Chipset and Model    : 16400X-P2B
BIOS Built Date     : 03/21/98

Choose one of the followings:
1. Save Current BIOS To File
2. Update BIOS Including Boot Block and ESCD

Enter choice: [1]

Press ESC To Exit
```

IMPORTANT! If “unknown” is displayed after **Flash Memory:**, the memory chip is either not programmable or is not supported by the ACPI BIOS and therefore, cannot be programmed by the Flash Memory Writer utility.

Main Menu

1. Save Current BIOS To File

This option allows you to save a copy of the original motherboard BIOS in case you need to reinstall it. It is recommended that you save **AFLASH.EXE** and the BIOS file to a bootable floppy disk.

To save your current BIOS, type [1] at the **Main Menu** and then press <Enter>. The **Save Current BIOS To File** screen appears.

Type a filename and the path, for example, **A:\XXX-X** and then press <Enter>.

```
          Save Current BIOS To File

Flash Memory: 32T 256K09

Current BIOS Version: 6015      ACPI BIOS Revision 1001
Chipset and Model    : 16400X-P2B
BIOS Built Date     : 03/21/98

Please Enter File Name to Save: A:\44881-1
```

IV. BIOS SETUP

2. Update BIOS Including Boot Block and ESCD

This option updates the boot block, the baseboard BIOS, and the ACPI extended system configuration data (ESCD) parameter block from a new BIOS file. See the next page for procedures on downloading an updated BIOS file.

To update your current BIOS, type [2] at the **Main Menu** and then press <Enter>. The **Update BIOS Including Boot Block and ESCD** screen appears. Type the filename of your new BIOS and the path, for example, **A:\XXXXXXXX.AWD**, and then press <Enter>.

When prompted to confirm the BIOS update, press **Y** to start the update.

The utility starts to program the new BIOS information into the flash ROM. When the programming is finished, *Flashed Successfully* will be displayed.

Follow the onscreen instructions to continue.

```
Update BIOS Including Boot Block and ESCD
Flash Memory: SST 29EE009
Current BIOS Version: 6015      ACPI BIOS Revision 1001
Chipset and Model : 154800-P2B
BIOS Built Date : 03/21/98
Please Enter File Name for NEW BIOS: A:\XXXXXXXX.AWD
```

```
Update BIOS Including Boot Block and ESCD
Flash Memory: SST 29EE009
BIOS Version
| CURRENT | 6015      ACPI BIOS Revision 1001
|XXXXXXXX.AWD| 6015      ACPI BIOS Revision 1002
Chipset and Model
| CURRENT | 154800-<CP2B>-B
|XXXXXXXX.AWD| 154800-<CP2B>-B
Date of BIOS Built
| CURRENT | 03/21/98
|XXXXXXXX.AWD| 03/25/98
Are you sure (Y/N) ? (Y)
Please ESC To Return to Main Menu
```

```
Update BIOS Including Boot Block and ESCD
Flash Memory: SST 29EE009
BIOS Version
| CURRENT | 6015      ACPI BIOS Revision 1001
|XXXXXXXX.AWD| 6015      ACPI BIOS Revision 1002
Chipset and Model
| CURRENT | 154800-<CP2B>-B
|XXXXXXXX.AWD| 154800-<CP2B>-B
Date of BIOS Built
| CURRENT | 03/21/98
|XXXXXXXX.AWD| 03/25/98
Are you sure (Y/N) ? (Y)
Programming -- 20FFF
Flashed Successfully
Please ESC To Return to Main Menu
```

```
6015 ACPI BIOS
FLASH MEMORY WRITER V1.0
Copyright (C) 1994-98, ASUSTek COMPUTER INC.
Flash Memory: SST 29EE009
Current BIOS Version: 6015      ACPI BIOS Revision 1001
Chipset and Model : 154800-P2B
BIOS Built Date : 03/21/98
Choose one of the followings:
1. Save Current BIOS To File
2. Update BIOS Including Boot Block and ESCD
Enter choice: [1]
You have flashed the EPROM! It is recommended that you turn off
the power, enter SETUP and Load Setup Defaults to have CMOS
updated with new BIOS when exits.
Please ESC To Exit
```

IV. BIOS SETUP

Managing and Updating Your Motherboard's BIOS

Upon First Use of the Computer System

1. Create a bootable system floppy disk by typing [FORMAT A:/S] from the DOS prompt without creating "AUTOEXEC.BAT" and "CONFIG.SYS" files.
2. Copy AFLASH.EXE to the just created boot disk.
3. Run AFLASH.EXE from this new disk and select option **1. Save Current BIOS to File**. See **1. Save Current BIOS To File** on the previous page for more details and the rest of the steps.

Updating BIOS Procedures (only when necessary)

1. Download an updated ASUS BIOS file from the Internet (WWW or FTP) or a BBS (Bulletin Board Service) (see ASUS CONTACT INFORMATION on page 3 for details) and save to the disk you created earlier.
2. Boot from the disk you created earlier.
3. At the "A:\>" prompt, type **AFLASH** and then press <Enter>.
4. At the **Main Menu**, type **2** and then press <Enter>. See **2. Update BIOS Including Boot Block and ESCD** on the previous page for more details and the rest of the steps.

WARNING! If you encounter problems while updating the new BIOS, DO NOT turn off your system since this might prevent your system from booting up. Just repeat the process, and if the problem still persists, update the original BIOS file you saved to disk above. If the Flash Memory Writer utility was not able to successfully update a complete BIOS file, your system may not be able to boot up. If this happens, your system will need service.

IV. BIOS SETUP

6. BIOS Setup

The motherboard supports two programmable Flash ROM chips: 5-Volt and 12-Volt. Either of these memory chips can be updated when BIOS upgrades are released. Use the Flash Memory Writer utility to download the new BIOS file into the ROM chip as described in detail in this section.

All computer motherboards provide a Setup utility program for specifying the system configuration and settings. If your motherboard came in a computer system, the proper configuration entries may have already been made. If so, invoke the Setup utility, as described later, and take note of the configuration settings for future reference; in particular, the hard disk specifications.

If you are installing the motherboard, reconfiguring your system or you receive a Run Setup message, you will need to enter new setup information. This section describes how to configure your system using this utility.

The BIOS ROM of the system stores the Setup utility. When you turn on the computer, the system provides you with the opportunity to run this program. This appears during the Power-On Self Test (POST). Press <Delete> to call up the Setup utility. If you are a little bit late pressing the mentioned key(s), POST will continue with its test routines, thus preventing you from calling up Setup. If you still need to call Setup, reset the system by pressing <Ctrl> + <Alt> + <Delete>, or by pressing the Reset button on the system case. You can also restart by turning the system off and then back on again. But do so only if the first two methods fail.

When you invoke Setup, the CMOS SETUP UTILITY main program screen will appear with the following options:



IV. BIOS SETUP

Load Defaults

The “Load BIOS Defaults” option loads the minimum settings for troubleshooting. “**Load Setup Defaults**”, on the other hand, is for loading optimized defaults for regular use. Choosing defaults at this level, will modify all applicable settings.

A section at the bottom of the above screen displays the control keys for this screen. Take note of these keys and their respective uses. Another section just below the control keys section displays information on the currently highlighted item in the list.

Standard CMOS Setup

The “Standard CMOS Setup” option allows you to record some basic system hardware configuration and set the system clock and error handling. If the motherboard is already installed in a working system, you will not need to select this option anymore. However, if the configuration stored in the CMOS memory on the board gets lost or damaged, or if you change your system hardware configuration, you will need to re-specify the configuration values. The configuration values usually get lost or corrupted when the power of the onboard CMOS battery weakens.



The preceding screen provides you with a list of options. At the bottom of this screen are the control keys for this screen. Take note of these keys and their respective uses.

User-configurable fields appear in a different color. If you need information on the selected field, press <F1>. The help menu will then appear to provide you with the information you need. The memory display at the lower right-hand side of the screen is read-only and automatically adjusts accordingly.

Details of Standard CMOS Setup:

Date

To set the date, highlight the “Date” field and then press either <Page Up>/<Page Down> or <+>/<-> to set the current date. Follow the month, day and year format. Valid values for month, day and year are: **Month: (1 to 12), Day: (1 to 31), Year: (up to 2079).**

IV. BIOS SETUP

Time

To set the time, highlight the “Time” field and then press either <Page Up>/<Page Down> or <+>/<-> to set the current time. Follow the hour, minute and second format. Valid values for hour, minute and second are: (**Hour: (00 to 23)**, **Minute: (00 to 59)**, **Second: (00 to 59)**).

NOTE: You can bypass the date and time prompts by creating an AUTOEXEC.BAT file. For information on how to create this file, please refer to the MS-DOS manual.

Hard Disks

This field records the specifications for all non-SCSI hard disk drives installed in your system. The onboard PCI IDE connectors provide Primary and Secondary channels for connecting up to four IDE hard disks or other IDE devices. Each channel can support up to two hard disks; the first of which is the “master” and the second is the “slave”.

Specifications for SCSI hard disks need not to be entered here since they operate using device drivers and are not supported by the BIOS. If you install other SCSI controller cards, refer to their respective documentations on how to install the required SCSI drivers.

For IDE hard disk drive setup, you can:

- Use the *Auto* setting for detection during bootup.
- Use the IDE HDD AUTO DETECTION in the main menu to automatically enter the drive specifications.
- Enter the specifications yourself manually by using the “User” option.

The entries for specifying the hard disk type include **CYLS** (number of cylinders), **HEAD** (number of read/write heads), **PRECOMP** (write precompensation), **LANDZ** (landing zone), **SECTOR** (number of sectors) and **MODE**. The **SIZE** field automatically adjusts according to the configuration you specify. The documentation that comes with your hard disk should provide you with the information regarding the drive specifications.

The **MODE** entry is for IDE hard disks only, and can be ignored for MFM and ESDI drives. This entry provides three options: *Normal*, *Large*, *LBA*, or *Auto* (see below). Set **MODE** to the *Normal* for IDE hard disk drives smaller than 528MB; set it to *LBA* for drives over 528MB that support Logical Block Addressing (LBA) to allow larger IDE hard disks; set it to *Large* for drives over 528MB that do not support LBA. *Large* type of drive can only be used with MS-DOS and is very uncommon. Most IDE drives over 528MB support the *LBA* mode.

IV. BIOS SETUP

Auto detection of hard disks on bootup

For each field: Primary Master, Primary Slave, Secondary Master, and Secondary Slave, you can select *Auto* under the TYPE and MODE fields. This will enable auto detection of your IDE hard disk during bootup. This will allow you to change your hard disks (with the power off) and then power on without having to reconfigure your hard disk type. If you use older hard disks that do not support this feature, then you must configure the hard disk in the standard method as described earlier by the “User” option.

NOTE: After the IDE hard disk drive information has been entered into BIOS, new IDE hard disk drives must be partitioned (such as with FDISK) and then formatted before data can be read from and write on. Primary IDE hard disk drives must have its partition set to *active* (also possible with FDISK).

NOTE: SETUP Defaults are noted in parenthesis next to each function heading.

Drive A / Drive B (None)

These fields record the types of floppy disk drives installed in your system. The available options for drives A and B are: *360K, 5.25 in.; 1.2M, 5.25 in.; 720K, 3.5 in.; 1.44M, 3.5 in.; 2.88M, 3.5 in.; None*

To enter the configuration value for a particular drive, highlight its corresponding field and then select the drive type using the <page up>/<page down> or <+>/<-> keys.

Floppy 3 Mode Support (Disabled)

This is the Japanese standard floppy drive. The standard stores 1.2MB in a 3.5inch diskette. This is normally disabled but you may choose from either: *Drive A, Drive B, Both, and Disabled*

Video (EGA/VGA)

Set this field to the type of video display card installed in your system. The options are *EGA/VGA, CGA 40, CGA 80, and MONO* (for Hercules or MDA).

If you are using a VGA or any higher resolution card, choose *EGA/VGA*.

Halt On (All Errors)

This field determines which types of errors will cause the system to halt. Choose from *All Errors; No Errors; All,But Keyboard, All,But Diskette; and All,But Disk/Key*.

IV. BIOS SETUP

BIOS Features Setup

The “BIOS Features Setup” option consists of configuration entries that allow you to improve your system performance, or let you set up some system features according to your preference. Some entries are required by the motherboard’s design to remain in their default settings.



A section at the lower right of the screen displays the control keys you can use. Take note of these keys and their respective uses. If you need information on a particular entry, highlight it and then press <F1>. A pop-up help menu will appear to provide you with the information you need. <F5> loads the last set values, <F6> and <F7> loads the BIOS default values and Setup default values, respectively.

NOTE: SETUP Defaults are noted in parenthesis next to each function heading.

Details of BIOS Features Setup

CPU Internal Core Speed

This function is reserved for future use and is currently disabled.

Boot Virus Detection (Enabled)

This field allows you to set boot virus detection, ensuring a virus-free boot sector. This new antivirus solution is unlike native BIOS tools, which offer limited virus protection typically by write-protecting the partition table. With this new solution, your computer is protected against boot virus threats earlier in the boot cycle, that is, before they have a chance to load into your system. This ensures your computer boots to a clean operating system. The system halts and displays a warning message when it detects a virus. If this occurs, you can either allow the operation to continue or use a virus-free bootable floppy disk to restart and investigate your system. Because of conflicts with new operating systems, for example, during installation of new software, you may have to set this to *Disabled* to prevent write errors.

IV. BIOS SETUP

CPU Level 1 Cache / CPU Level 2 Cache (Enabled)

These fields allow you to choose from the default of *Enabled* or choose *Disabled* to turn on or off the CPU's Level 1 and Level 2 built-in cache.

CPU Level 2 Cache ECC Check (Disabled)

This function controls the ECC check capability in the CPU level 2 cache.

BIOS Update (Enabled)

This functions as an update loader integrated into the BIOS to supply the processor with the required data. The BIOS will load the update on all processors during system bootup in the default position of *Enabled*.

Turbo Mode (Disabled)

Leave on default setting.

Quick Power On Self Test (Enabled)

This field speeds up the Power-On Self Test (POST) routine by skipping retesting a second, third, and fourth time. Setup default setting for this field is *Enabled*. A complete test of the system is done on each test.

HDD Sequence SCSI/IDE First (IDE)

When using both SCSI and IDE hard disk drives, IDE is always the boot disk using drive letter C (default setting of *IDE*). This new feature allows a SCSI hard disk drive to be the boot disk when set to *SCSI*. This allows multiple operating systems to be used on both IDE and SCSI drives or the primary operating system to boot using a SCSI hard disk drive.

Boot Sequence (A,C)

This field determines where the system looks first for an operating system. Options are *A,C*; *C,A*; *A,CDROM,C*; *CDROM,C,A*; *D,A*; *E,A*; *F,A*; *C only*; *LS/ZIP, C*; *LAN,A,C*; and *LAN,C,A*. The setup default setting, *A, C*, is to check first the floppy disk and then the hard disk drive.

Boot Up Floppy Seek (Disabled)

When enabled, the BIOS will seek drive A once.

Floppy Disk Access Control (R/W)

This allows protection of files from the computer system to be copied to floppy disks by allowing the setting of *Read Only* to only allow reads from the floppy disk drive but not writes. The setup default *R/W* allows both reads and writes.

IDE HDD Block Mode Sectors (HDD MAX)

This field enhances hard disk performance by making multi-sector transfers instead of one sector per transfer. Most IDE drives, except older versions, can utilize this feature. Selections are *HDD MAX*, *Disabled*, *2*, *4*, *8*, *16*, and *32*.

HDD S.M.A.R.T. capability (Disabled)

This allows the enabling or disabling of the S.M.A.R.T. (Self-Monitoring, Analysis and Reporting Technology) system which utilizes internal hard disk drive monitoring technology. This feature is normally disabled because system resources used in this feature may decrease system performance.

IV. BIOS SETUP

PS/2 Mouse Function Control (Auto)

The default of *Auto* allows the system to detect a PS/2 mouse on bootup. If detected, IRQ12 will be used for the PS/2 mouse. IRQ12 will be reserved for expansion cards if a PS/2 mouse is not detected. *Enabled* will always reserve IRQ12, whether on bootup a PS/2 mouse is detected or not.

OS/2 Onboard Memory > 64M (Disabled)

When using OS/2 operating systems with installed DRAM of greater than 64MB, you need to set this option to *Enabled* otherwise leave this on *Disabled*.

.....

PCI/VGA Palette Snoop (Disabled)

Some display cards that are nonstandard VGA such as graphics accelerators or MPEG Video Cards may not show colors properly. The setting *Enabled* should correct this problem. Otherwise leave this on the setup default setting of *Disabled*.

Video ROM BIOS Shadow (Enabled)

This field allows you to change the video BIOS location from ROM to RAM. Relocating to RAM enhances system performance, as information access is faster than the ROM.

C8000-CBFFF to DC000-DFFFF (Disabled)

These fields are used for shadowing other expansion card ROMs. If you install other expansion cards with ROMs on them, you will need to know which addresses the ROMs use to shadow them specifically. Shadowing a ROM reduces the memory available between 640K and 1024K by the amount used for this purpose.

Boot Up NumLock Status (On)

This field enables users to activate the Number Lock function upon system boot.

Typematic Rate Setting (Disabled)

When enabled, you can set the two typematic controls listed next. Setup default setting is *Disabled*.

Typematic Rate (Chars/Sec) (6)

This field controls the speed at which the system registers repeated keystrokes. Options range from 6 to 30 characters per second. Setup default setting is **6**; other settings are 8, 10, 12, 15, 20, 24, and 30.

Typematic Delay (Msec) (250)

This field sets the time interval for displaying the first and second characters. Four delay rate options are available: 250, 500, 750, and 1000.

Security Option (System)

When you specify a *Supervisor Password* and/or *User Password* (explained later in this section), the Security Option field determines when the system prompts for the password. The default setting is *System*, where the system prompts for the User Password every time you start your system. The other option is *Setup*, where the system goes through its startup routine unless the Setup utility is called, when the system prompts for the Supervisor Password.

IV. BIOS SETUP

Chipset Features Setup

The “Chipset Features Setup” option controls the configuration of the board’s chipset.



NOTE: SETUP Defaults are noted in parenthesis next to each function heading.

Details of Chipset Features Setup

SDRAM Configuration (By SPD)

This sets the optimal timings of settings for items 2–5, depending on the memory modules that you are using. Default setting is *By SPD*, which configures items 2–5 by reading the contents in the SPD (Serial Presence Detect) device. This 8-pin serial EEPROM device stores critical parameter information about the module, such as memory type, size, speed, voltage interface, and module banks.

SDRAM CAS Latency

This controls the latency between SDRAM read command and the time that the data actually becomes available. Leave on default setting.

SDRAM RAS to CAS Delay

This controls the latency between SDRAM active command and the read/write command. Leave on default setting.

SDRAM RAS Precharge Time

This controls the idle clocks after issuing a precharge command to SDRAM. Leave on default setting.

DRAM Idle Timer

This controls the idle clocks before closing an opened SDRAM page. Leave on default setting.

SDRAM MA Wait State (Normal)

This controls the leadoff clocks for CPU read cycles. Leave on default setting.

Snoop Ahead (Enabled)

Enabled will allow PCI streaming. Leave on default setting.

Host Bus Fast Data Ready (Disabled)

Leave on default setting.

IV. BIOS SETUP

16-bit I/O Recovery Time (1 BUSCLK) / 8-bit I/O Recovery Time (1 BUSCLK)

Timing for 16-bit and 8-bit ISA cards, respectively. Leave on default setting.

Graphics Aperture Size (64MB)

Memory-mapped, graphics data structures can reside in a Graphics Aperture. Leave on default setting.

Video Memory Cache Mode (UC)

USWC (uncacheable, speculative write combining) is a new cache technology for the video memory of the processor. It can greatly improve the display speed by caching the display data. You must leave this on the default setting of *UC* (uncacheable) if your display card cannot support this feature, otherwise your system may not boot.

PCI 2.1 Support (Enabled)

This function allows you to enable or disable PCI 2.1 features including passive release and delayed transaction. Leave *Enabled* (default setting) for PCI 2.1 compliancy.

Memory Hole At 15M–16M (Disabled)

Enabling this feature reserves 15MB to 16MB memory address space to ISA expansion cards that specifically require this setting. This makes the memory from 15MB and up unavailable to the system. Expansion cards can only access memory up to 16MB. The default is *Disabled*.

Onboard FDC Controller (Enabled)

When *Enabled*, this field allows you to connect your floppy disk drives to the onboard floppy disk drive connector instead of a separate controller card. If you want to use a different controller card to connect the floppy disk drives, set this field to *Disabled*.

Onboard FDC Swap A & B (No Swap)

This field allows you to reverse the hardware drive letter assignments of your floppy disk drives. Two options are available: *No Swap* and *Swap AB*. If you want to switch drive letter assignments through the onboard chipset, set this field to *Swap AB*.

Onboard Serial Port 1 (3F8H/IRQ4)

Settings are *3F8H/IRQ4*, *2F8H/IRQ3*, *3E8H/IRQ4*, *2E8H/IRQ10*, and *Disabled* for the onboard serial connector.

Onboard Serial Port 2 (2F8H/IRQ3)

Settings are *3F8H/IRQ4*, *2F8H/IRQ3*, *3E8H/IRQ4*, *2E8H/IRQ10*, and *Disabled* for the onboard serial connector.

IV. BIOS SETUP

Onboard Parallel Port (378H/IRQ7)

This field sets the address of the onboard parallel port connector. You can select either: *3BCH/IRQ 7*, *378H/IRQ 7*, *278H/IRQ 5*, *Disabled*. If you install an I/O card with a parallel port, ensure that there is no conflict in the address assignments. The PC can support up to three parallel ports as long as there are no conflicts for each port.

Parallel Port Mode (ECP+EPP)

This field allows you to set the operation mode of the parallel port. The setting *Normal*, allows normal-speed operation but in one direction only; *EPP* allows bidirectional parallel port operation at maximum speed; *ECP* allows the parallel port to operate in bidirectional mode and at a speed faster than the maximum unidirectional data transfer rate; *ECP+EPP* allows normal speed operation in a two-way mode.

ECP DMA Select (3)

This selection is available only if you select *ECP* or *ECP+EPP* in the **Parallel Port Mode**. Select either DMA Channel *1*, *3*, or *Disable*.

UART2 Use Infrared (Disabled)

When enabled, this field activates the onboard infrared feature and sets the second serial UART to support the infrared module connector on the motherboard. If your system already has a second serial port connected to the onboard COM2 connector, it will no longer work if you enable the infrared feature. By default, this field is set to *Disabled*, which leaves the second serial port UART to support the COM2 serial port connector. See **IrDA-compliant infrared module connector** under in **HARDWARE SETUP**.

Onboard PCI IDE Enable (Both)

You can select to enable the *primary* IDE channel, *secondary* IDE channel, *both*, or *disable* both channels (for systems with only SCSI drives).

IDE Ultra DMA Mode (Auto)

This field autodetects Ultra DMA capability (for improved transfer speeds and data integrity) for compatible IDE devices. Set to *Disable* to suppress Ultra DMA capability.

IDE 0 Master/Slave PIO/DMA Mode, IDE 1 Master/Slave PIO/DMA Mode (Auto)

Each channel (0 and 1) has both a master and a slave making four IDE devices possible. Because each IDE device may have a different Mode timing (0, 1, 2, 3, 4), it is necessary for these to be independent. The default setting of *Auto* will allow autodetection to ensure optimal performance.

IV. BIOS SETUP

Power Management Setup

The “Power Management Setup” option allows you to reduce power consumption. This feature turns off the video display and shuts down the hard disk after a period of inactivity.



NOTE: SETUP Defaults are noted in parenthesis next to each function heading.

Details of Power Management Setup

Power Management (User Define)

This field acts as the master control for the power management modes. *Max Saving* puts the system into power saving mode after a brief period of system inactivity; *Min Saving* is almost the same as *Max Saving* except that this time the system inactivity period is longer; *Disable* disables the power saving features; *User Define* allows you to set power saving options according to your preference.

IMPORTANT: Advanced Power Management (APM) should be installed to keep the system time updated when the computer enters suspend mode activated by the BIOS Power Management. For DOS environments, you need to add the statement, `DEVICE=C:\DOS\POWER.EXE`, in you `CONFIG.SYS`. For Windows 3.x and Windows 95, you need to install Windows with the APM feature. A battery and power cord icon labeled “Power” will appear in the “Control Panel.” Choose “Advanced” in the Power Management Field.

Video Off Option (Suspend -> Off)

This field determines when to activate the video off feature for monitor power management. The settings are *Always On* and *Suspend -> Off*.

IV. BIOS SETUP

Video Off Method (DPMS OFF)

This field defines the video off features. The following options are available: *DPMS OFF*, *DPMS Reduce ON*, *Blank Screen*, *V/H SYNC+Blank*, *DPMS Standby*, and *DPMS Suspend*. The DPMS (Display Power Management System) features allow the BIOS to control the video display card if it supports the DPMS feature. *Blank Screen* only blanks the screen (use this for monitors without power management or “green” features. If set up in your system, your screen saver will not display with *Blank Screen* selected). *V/H SYNC+Blank* blanks the screen and turns off vertical and horizontal scanning.

.....

PM Timers

This section controls the time-out settings for the Power Management scheme. The fields included in this section are “HDD Power Down”, which places the hard disk into its lowest power consumption mode, and the “Suspend Mode” which suspends the CPU.

The system automatically “wakes up” from any power saving mode when there is system activity such as when a key is pressed from the keyboard, or when there is activity detected from the enabled IRQ channels.

HDD Power Down (Disable)

Shuts down any IDE hard disk drives in the system after a period of inactivity. This time period is user-configurable to *1–15 Min* or *Disable*. This feature does not affect SCSI hard drives.

Suspend Mode (Disable)

Sets the period of time after which each of these modes activate: *30 sec*, *1 Min*, *2 Min*, *4 Min*, *8 Min*, *20 Min*, *30 Min*, *40 Min*, *1 Hour*, and *Disable*.

.....

Power Up Control

This section determines the ways the system can be controlled when it is started or restarted, when modem activity is detected, or when power to the computer is interrupted and reapplied. The Soft-Off mode refers to powering off the system through a momentary button switch (ATX switch) or through the software as opposed to disconnecting the AC power by way of a rocker switch or other means.

PWR Button < 4 Secs (Soft Off)

When set to *Soft Off*, the ATX switch can be used as a normal system power-off button when pressed for less than 4 seconds. *Suspend* allows the button to have a dual function where pressing less than 4 seconds will place the system in sleep mode. Regardless of the setting, holding the ATX switch for more than 4 seconds will power off the system.

IV. BIOS SETUP

PWR Up On Modem Act (Enabled)

This allows either settings of *Enabled* or *Disabled* for powering up the computer (turns the ATX power supply on) when the modem receives a call while the computer is Soft-off.

NOTE: The computer cannot receive or transmit data until the computer and applications are fully running, thus connection cannot be made on the first try. Turning an external modem off and then back on while the computer is off causes an initialization string that will also cause the system to power on.

AC PWR Loss Restart (Disabled)

This allows you to set whether you want your system to boot up after the power has been interrupted. *Disabled* leaves your system off after reapplying power and *Enabled* boots up your system after reapplying power.

Wake On LAN (Enabled)

This allows you to remotely power up your system through your network by sending a wake-up frame or signal. With this feature, you can remotely upload/download data to/from systems during off-peak hours. *Enabled* sets this feature.

IMPORTANT: This feature requires the optional network interface and an ATX power supply with at least 720mA +5V standby power.

Automatic Power Up (Disabled)

This allows you to have an unattended or automatic power up of your system. You may configure your system to power up at a certain time of the day by selecting *Everyday*, which will allow you to set the time or at a certain time and day by selecting *By Date*.

.....

Fan Monitor (xxxxRPM)

The onboard hardware monitor is able to detect the Chassis Fan Speed, CPU Fan Speed, and the Power Supply Fan Speed in Rotations Per Minute (RPM). Set to *Ignore* if one of these are not used so that error messages will not be given.

.....

Thermal Monitor (xxxC/xxxF)

The onboard hardware monitor is able to detect the CPU and MB (motherboard) temperatures. Set to *Ignore* only if necessary.

.....

Voltage Monitor (xx.xV)

The onboard hardware monitor is able to detect the voltages put out by the voltage regulators. Set to *Ignore* only if necessary.

NOTE: If any of the monitored items are out of range, an error message will appear: "Hardware Monitor found an error, enter POWER MANAGEMENT SETUP for details". You will then be prompted to "Press **F1** to continue, **DEL** to enter SETUP".

IV. BIOS SETUP

PNP and PCI Setup

The “PNP and PCI Setup” option configures the PCI bus slots. All PCI bus slots on the system use INTA#, thus all installed PCI cards must be set to this value.



NOTE: SETUP Defaults are noted in parenthesis next to each function heading.

Details of PNP and PCI Setup

PNP OS Installed (No)

This field allows you to use a Plug-and-Play (PnP) operating system to configure the PCI bus slots instead of using the BIOS. Thus interrupts may be reassigned by the OS when *Yes* is selected. When a non-PnP OS is installed or to prevent reassigning of interrupt settings, select the default setting of *No*.

Slot 1/Audio IRQ (5)

This field sets the IRQ for PCI slot 1 which is shared with the onboard audio. The default setting for this field is 5.

Slot 2 IRQ / Slot 3 IRQ (Auto)

These fields set how IRQ use is determined for each PCI slot. The default setting for each field is *Auto*, which uses auto-routing to determine IRQ use. The other options are manual settings of *NA*, 3, 4, 5, 7, 9, 10, 11, 12, 14 or 15 for each slot.

PCI Latency Timer (32 PCI Clock)

The default setting of 32 *PCI Clock* enables maximum PCI performance for this motherboard.

.....

IV. BIOS SETUP

IRQ xx Used By ISA (No/ICU)

These fields indicate whether or not the displayed IRQ for each field is being used by a legacy (non-PnP) ISA card. Two options are available: *No/ICU* and *Yes*. The first option, the default value, indicates either that the displayed IRQ is not used or an ISA Configuration Utility (ICU) is being used to determine if an ISA card is using that IRQ. If you install a legacy ISA card that requires a unique IRQ, and you are not using an ICU, you must set the field for that IRQ to *Yes*. For example: If you install a legacy ISA card that requires IRQ 10, then set **IRQ10 Used By ISA** to *Yes*.

DMA x Used By ISA (No/ICU)

These fields indicate whether or not the displayed DMA channel for each field is being used by a legacy (non-PnP) ISA card. Available options include: *No/ICU* and *Yes*. The first option, the default setting, indicates either that the displayed DMA channel is not used or an ICU is being used to determine if an ISA card is using that channel. If you install a legacy ISA card that requires a unique DMA channel, and you are not using an ICU, you must set the field for that channel to *Yes*.

ISA MEM Block BASE (No/ICU)

This field allows you to set the base address and block size of a legacy ISA card that uses any memory segment within the C800H and DFFFH address range. If you have such a card, and you are not using an ICU to specify its address range, select a base address from the six available options; the **ISA MEM Block SIZE** field will then appear for selecting the block size. If you have more than one legacy ISA card in your system that requires to use this address range, you can increase the block size to either 8K, 16K, 36K, or 64K. If you are using an ICU to accomplish this task, leave **ISA MEM Block BASE** to its default setting of *No/ICU*.

Symbios SCSI BIOS (Auto)

Auto allows the BIOS to detect whether you have a Symbios SCSI card, if detected the onboard Symbios BIOS will be enabled, if not then it will be disabled. *Disabled* prevents the onboard Symbios BIOS to be enabled so that the external Symbios SCSI card's own BIOS can be used instead. **Note:** If your Symbios SCSI card does not have a BIOS, the Symbios SCSI card will not function.

USB IRQ (Enabled)

Enabled reserves an IRQ# for the USB to work, *Disabled* does not allow the USB to have an IRQ# and therefore prevents the USB from functioning. If you are not using any USB devices, you may set this feature to *Disabled* to save an extra IRQ# for expansion cards.

VGA BIOS Sequence (PCI/AGP)

You can select the search order for your VGA card(s). *PCI/AGP* will detect PCI VGA cards before AGP, and *AGP/PCI* will detect AGP cards before PCI VGA.

IV. BIOS SETUP

Load BIOS Defaults

The “Load BIOS Defaults” option allows you to load the troubleshooting default values permanently stored in the BIOS ROM. These default settings are non-optimal and disable all high performance features. To load these default settings, highlight “Load BIOS Defaults” on the main screen and then press <Enter>. The system displays a confirmation message on the screen. Press <Y> and then <Enter> to confirm. Press <N> and then <Enter> to abort. This feature does not affect the fields on the Standard CMOS Setup screen.

Load Setup Defaults

The “Load Setup Defaults” option allows you to load the default values to the system configuration fields. These default values are the optimized configuration settings for the system. To load these default values, highlight “Load Setup Defaults” on the main screen and then press <Enter>. The system displays a confirmation message on the screen. Press <Y> and then <Enter> to confirm. Press <N> and then <Enter> to abort. This feature does not affect the fields on the Standard CMOS Setup screen.

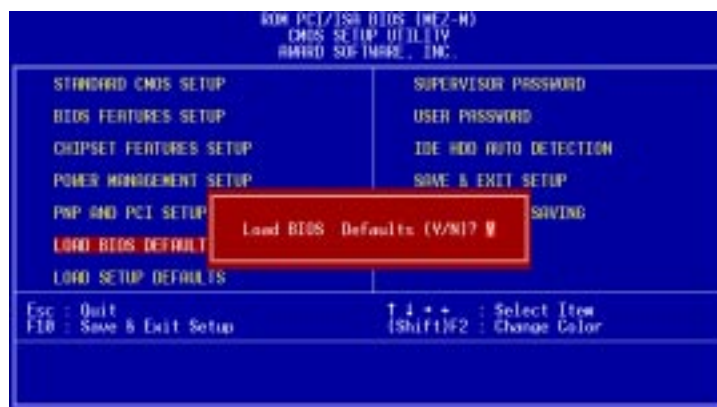

IV. BIOS SETUP

Supervisor Password and User Password

These two options set the system passwords. “Supervisor Password” sets a password that will be used to protect the system and the Setup utility; “User Password” sets a password that will be used exclusively on the system. By default, the system comes without any passwords. To specify a password, highlight the type you want and then press <Enter>. A password prompt appears on the screen. Taking note that the password is case sensitive, and can be up to 8 alphanumeric characters long, type in your password and then press <Enter>. The system confirms your password by asking you to type it again. After setting a password, the screen automatically reverts to the main screen.



To implement password protection, specify in the “Security Option” field of the BIOS Features Setup screen when the system will prompt for the password. If you want to disable either password, press <Enter> instead of entering a new password when the “Enter Password” prompt appears. A message confirms the password has been disabled.

Forgot the password?

If you forgot the password, you can clear the password by erasing the CMOS Real Time Clock (RTC) RAM. The RAM data containing the password information is powered by the onboard button cell battery. To erase the RTC RAM: (1) Unplug your computer, (2) Short the solder points, (3) Turn ON your computer, (4) Hold down <Delete> during bootup and enter BIOS setup to re-enter user preferences.

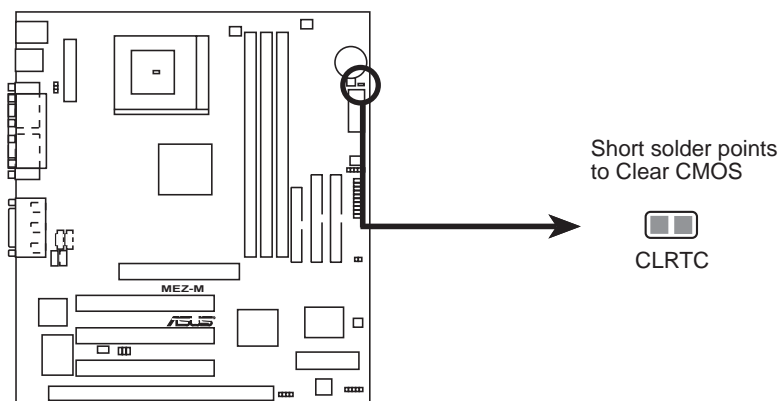

MEZ-M Clear RTC RAM

IV. BIOS SETUP

IDE HDD Auto Detection

The “IDE HDD Auto Detection” option detects the parameters of an IDE hard disk drive, and automatically enters them into the Standard CMOS Setup screen.

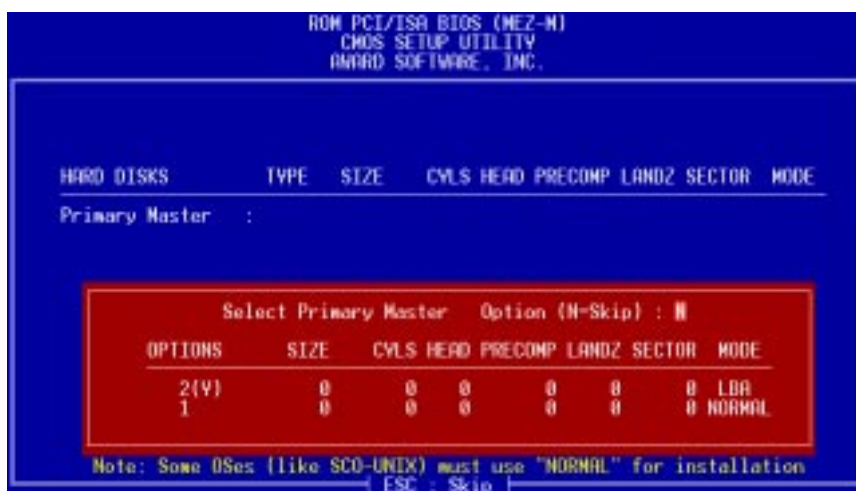

Up to four IDE drives can be detected, with parameters for each listed inside the box. To accept the optimal entries, press <Y> or else select from the numbers displayed under the OPTIONS field (2, 1, 3 in this case); to skip to the next drive, press <N>. If you accept the values, the parameters will appear listed beside the drive letter on the screen. The process then proceeds to the next drive letter. Pressing <N> to skip rather than to accept a set of parameters causes the program to enter zeros after that drive letter.

Remember that if you are using another IDE controller that does not feature Enhanced IDE support for four devices, you can only install two IDE hard disk drives. Your IDE controller must support the Enhanced IDE features in order to use Drive E and Drive F. The onboard PCI IDE controller supports Enhanced IDE, with two connectors for connecting up to four IDE devices. If you want to use another controller that supports four drives, you must disable the onboard IDE controller in the Chipset Features Setup screen.

When auto-detection is completed, the program automatically enters all entries you accepted on the field for that drive in the Standard CMOS Setup screen. Skipped entries are ignored and are not entered in the screen.

If you are auto-detecting a hard disk that supports the LBA mode, three lines will appear in the parameter box. Choose the line that lists LBA for an LBA drive. Do not select Large or Normal.

The auto-detection feature can only detect one set of parameters for a particular IDE hard drive. Some IDE drives can use more than one set. This is not a problem if the drive is new and empty.

IV. BIOS SETUP

IMPORTANT: If your hard disk was already formatted on an older previous system, incorrect parameters may be detected. You will need to enter the correct parameters manually or use low-level format if you do not need the data stored on the hard disk.

If the parameters listed differ from the ones used when the disk was formatted, the disk will not be readable. If the auto-detected parameters do not match the ones that should be used for your disk, do not accept them. Press <N> to reject the presented settings and enter the correct ones manually from the Standard CMOS Setup screen.

Save & Exit Setup

Select this option to save into the CMOS memory all modifications you specified during the current session. To save the configuration changes, highlight the “Save & Exit Setup” option on the main screen, type “Y”, and then press <Enter>.



Exit Without Saving

Select this option to exit the Setup utility without saving the modifications you specify during the current session. To exit without saving, highlight the “Exit Without Saving” option on the main screen and then press <Enter>.

IV. BIOS SETUP

(This page was intentionally left blank.)

V. SOFTWARE SETUP



V. SW SETUP

V. SOFTWARE SETUP

V. SOFTWARE SETUP	59
Operating Systems	61
MEZ-M Support CD (Windows 98)	61
Support CD Contents	62
Installing the ESS Audio Driver	63
Installing AudioRack32	64
Installing the Software Wavetable	65
Installing PCCillin	66
Installing Adobe Acrobat Reader	67
Installing ASUS PC Probe	68
LDCM Local Setup	69
LDCM Local Setup	70
LDCM Administrator Setup	71
Uninstalling Programs	72

V. SOFTWARE SETUP

Operating Systems

You should always use the latest operating system and updates when using new hardware in order to ensure full compliancy. For Windows 95, you must use OSR 2.0 or later. For Windows NT 4.0, you must use Service Pack 3.0 or later.

MEZ-M Support CD (Windows 98)

Insert the support CD or double-click your CD drive icon in **My Computer** to bring up the autorun menu or run **Setup.exe** in the root directory of the Support CD.

NOTE: The Support CD contents are constantly updated without notice.

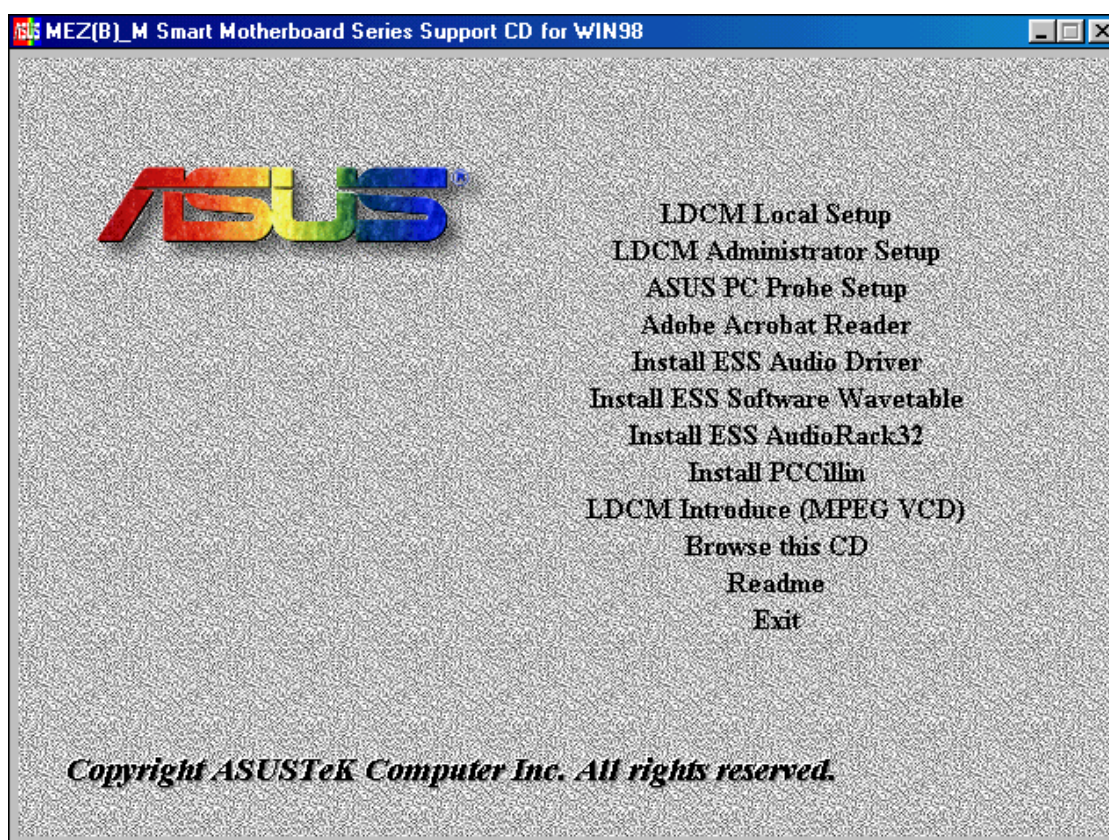

NOTE: The screen displays in this section may not reflect exactly the screen contents displayed on your screen.

V. SOFTWARE SETUP

Support CD Contents

- **LDCM Local Setup:** Installs software to monitor the local system. The LANDesk Client Manager must be installed in order to use the hardware manager features.
- **LDCM Administrator Setup:** Installs software to monitor PC systems on the network within the same bridge address with the Local software installed. The administrator should install both Local and Administrator Software.
- **ASUS PC Probe:** Installs a simple utility to monitor your computer's fan, temperature, and voltages. (NOTE: Will not run with LDCM installed.) Please refer to the user's manual in Adobe Acrobat PDF format located in the "ASUSLM" directory on the ASUS Support CD or see the PC Probe section in this user's manual.
- **Adobe Acrobat Reader:** Installs the Adobe Acrobat Reader software necessary to view the LDCM manual in the LDCM directory.
- **Install ESS Audio Driver:** Audio driver installation instructions for the onboard audio.
- **Install ESS Software Wave Table:** Expands the audio sound capability for increased sound effects.
- **Install ESS AudioRack32:** Installs the ESS AudioRack utilities. Refer to the online help for more information.
- **Install PCCillin:** Installs "PC-cillin" virus protection software. View the online help if you have any questions.
- **Browse this CD:** Allows you to see the contents of the ASUS support CD.
- **Read Me:** View additional notes with Notepad.
- **LDCM Introduce (MPEG VCD):** View a video on the LDCM features.
- **Exit:** Exit the selection menu.

Additional CD Contents: The DMI Configuration Utility in the **DMI** directory and Flash BIOS writer in the **AFLASH** directory.

V. SOFTWARE SETUP

Installing the ESS Audio Driver

Insert the Support CD that came with your motherboard into your CD-ROM drive or double-click the CD drive icon in **My Computer** to bring up the autorun screen.

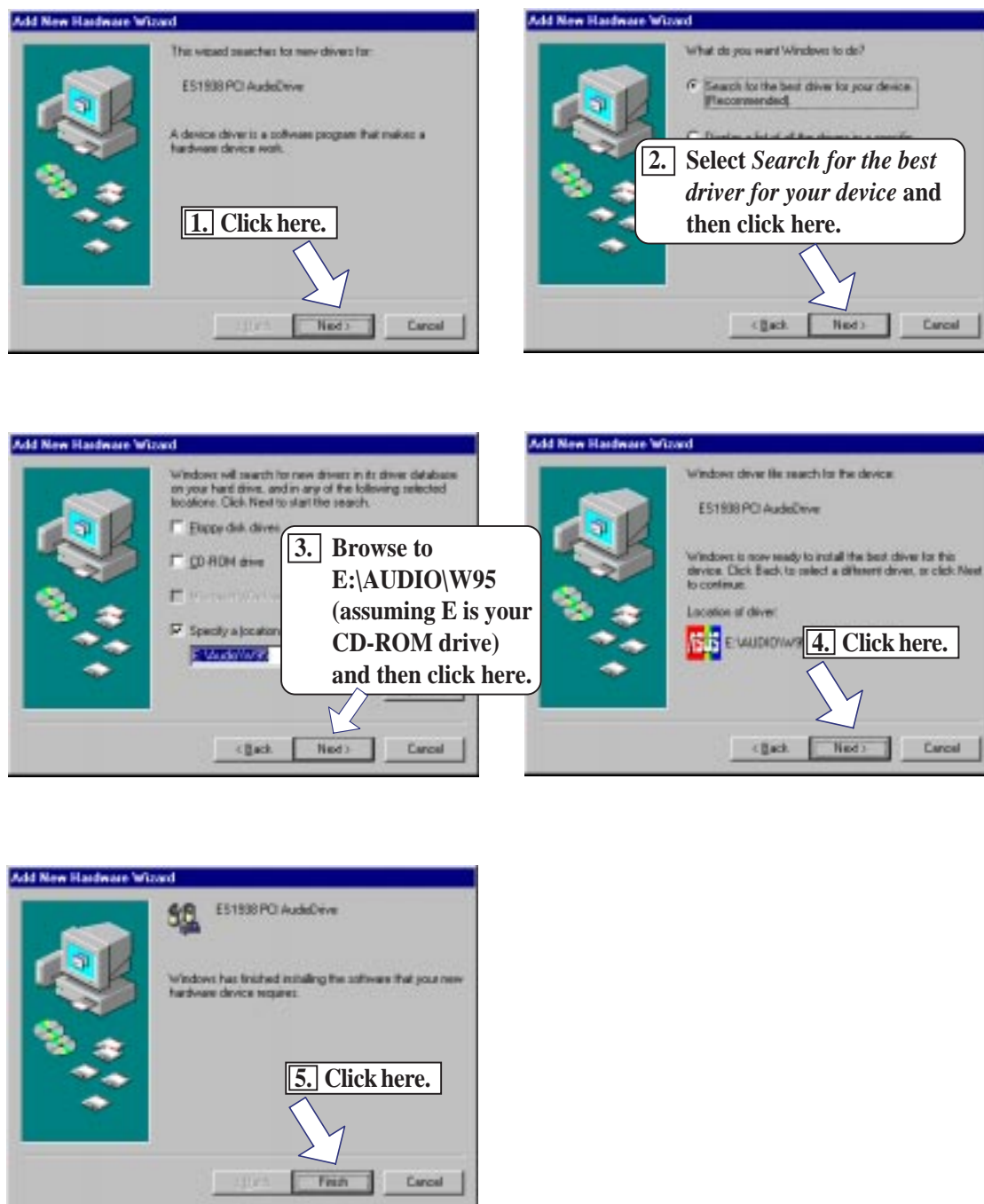

V. SOFTWARE SETUP

Installing AudioRack32

Insert the Support CD that came with your motherboard into your CD-ROM drive or double-click the CD drive icon in **My Computer** to bring up the autorun screen.

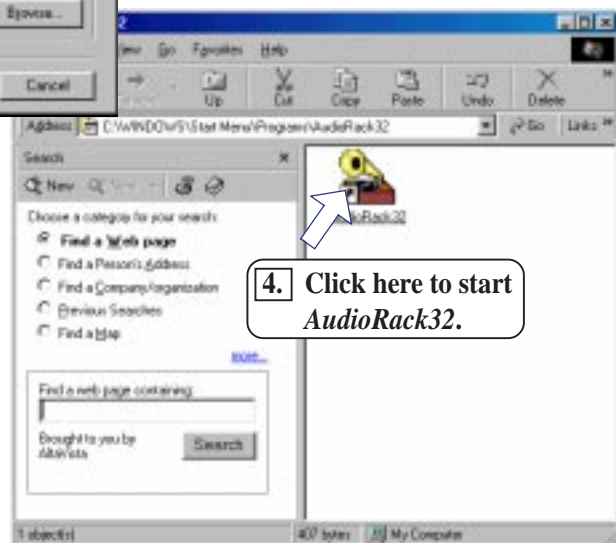
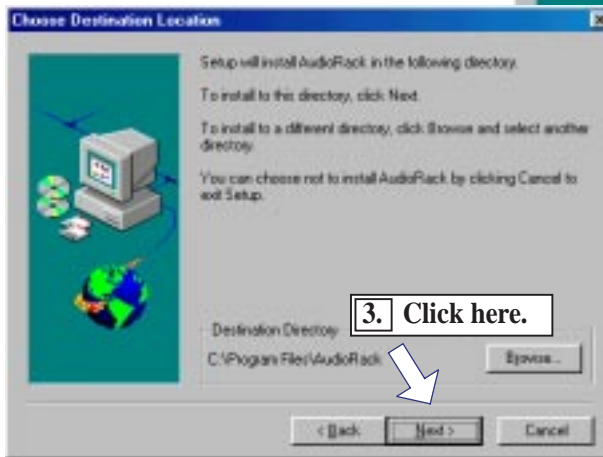
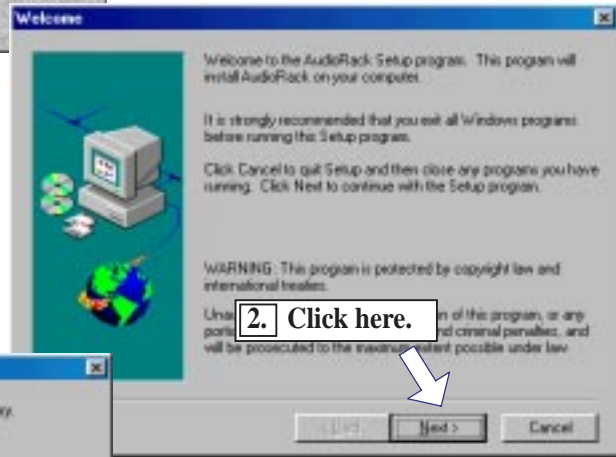
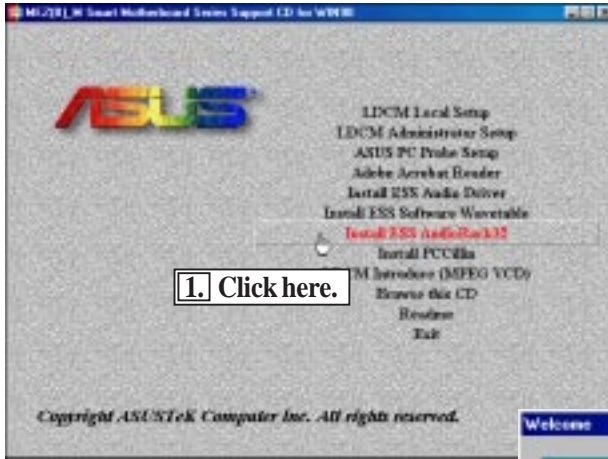

V. SOFTWARE SETUP

Installing the Software Wavetable

Insert the Support CD that came with your motherboard into your CD-ROM drive or double-click the CD drive icon in **My Computer** to bring up the autorun screen.

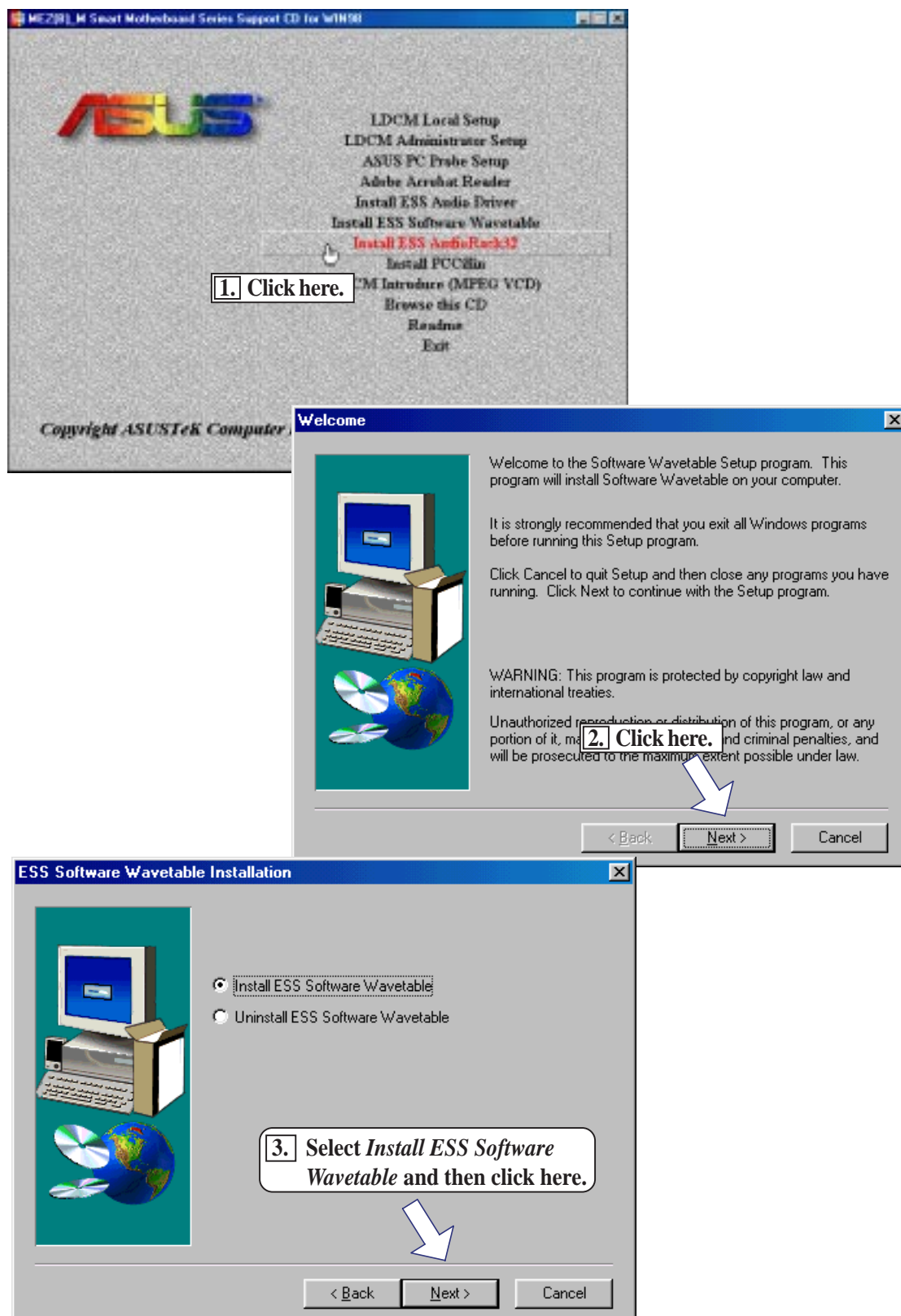

Installing PCCillin

Insert the Support CD that came with your motherboard into your CD-ROM drive or double-click the CD drive icon in **My Computer** to bring up the autorun screen.

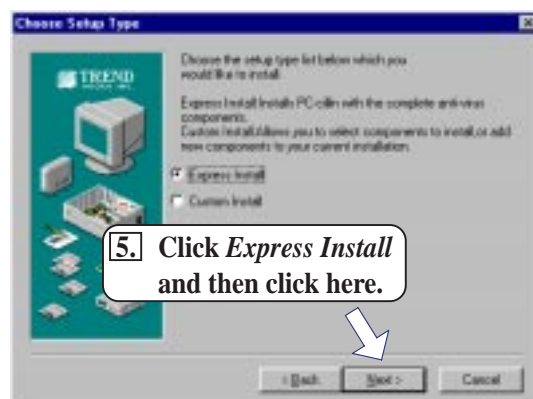

V. SOFTWARE SETUP

Installing Adobe Acrobat Reader

Insert the Support CD that came with your motherboard into your CD-ROM drive or double-click the CD drive icon in **My Computer** to bring up the autorun screen.

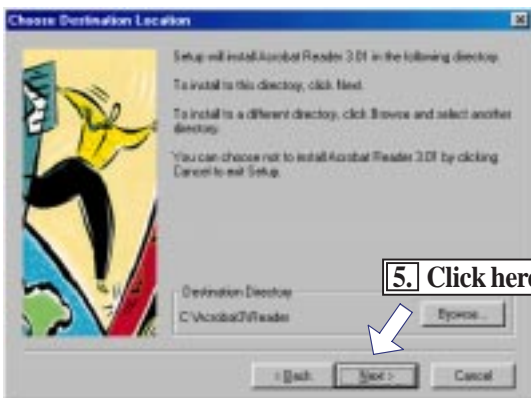
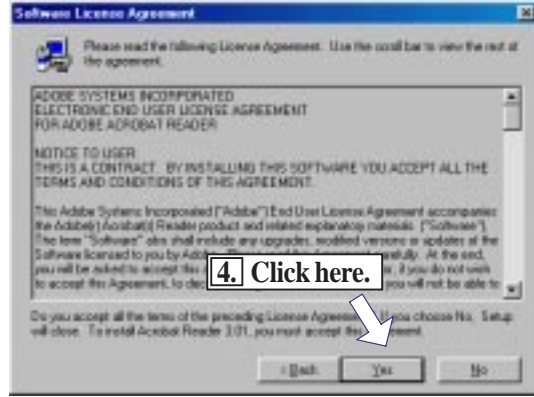
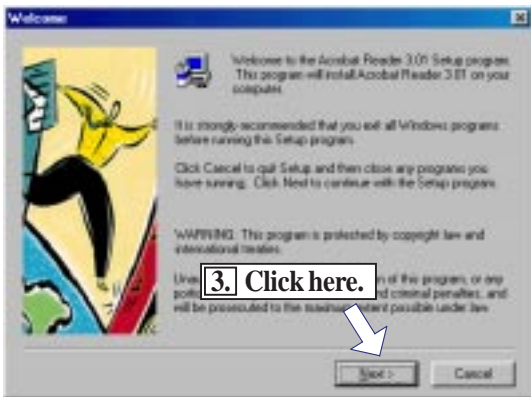
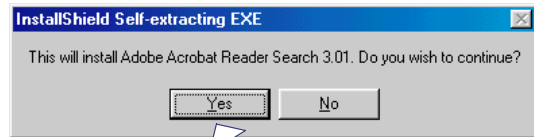

V. SOFTWARE SETUP

Installing ASUS PC Probe

Insert the Support CD that came with your motherboard into your CD-ROM drive or double-click the CD drive icon in **My Computer** to bring up the autorun screen.

NOTE: ASUS PC Probe will not run if Intel's LDCM utility is installed. To uninstall Intel's LDCM utility, see section on *Uninstalling Programs*.

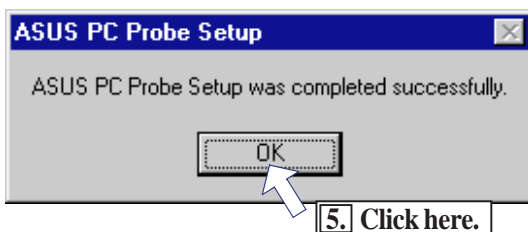
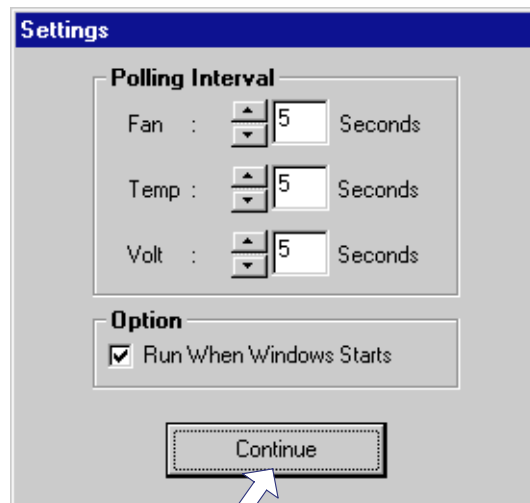
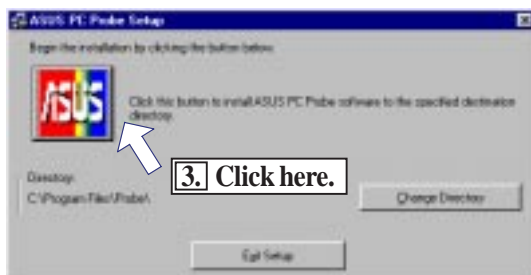
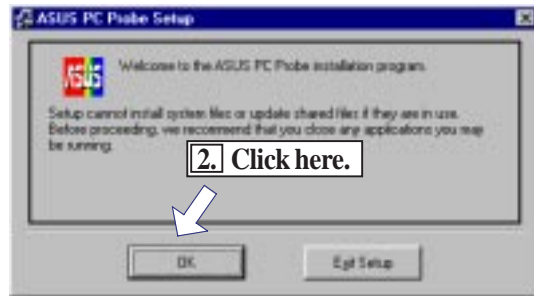
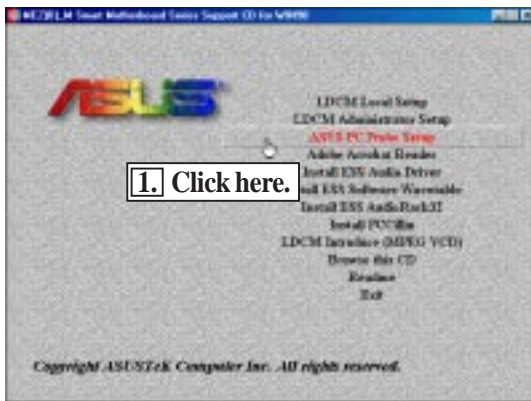

V. SOFTWARE SETUP

LDCM Local Setup

Insert the Support CD that came with your motherboard into your CD-ROM drive or double-click the CD drive icon in **My Computer** to bring up the autorun screen.

NOTE: LDCM will not run if ASUS' PC Probe utility is installed. To uninstall PC Probe, see section on *Uninstalling Programs*.

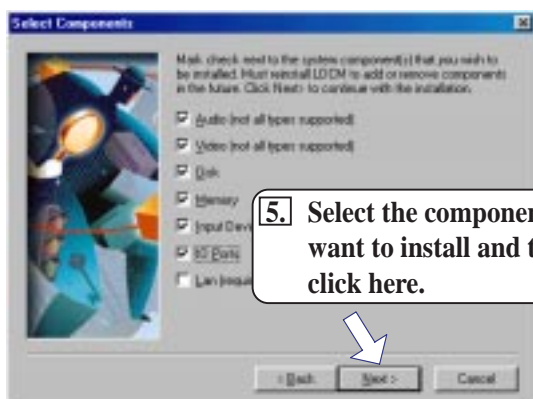
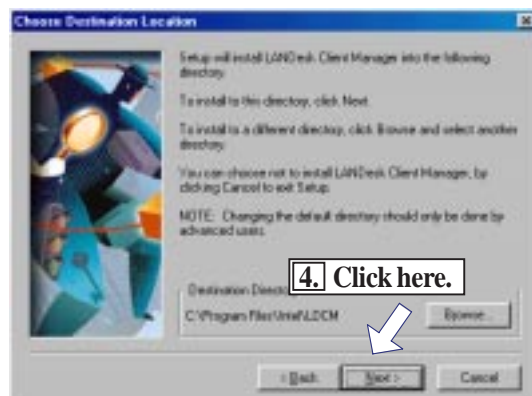
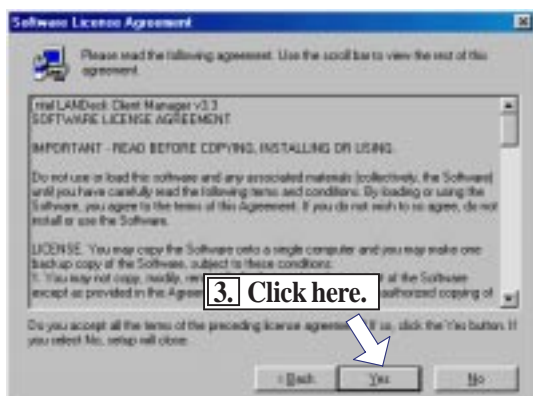
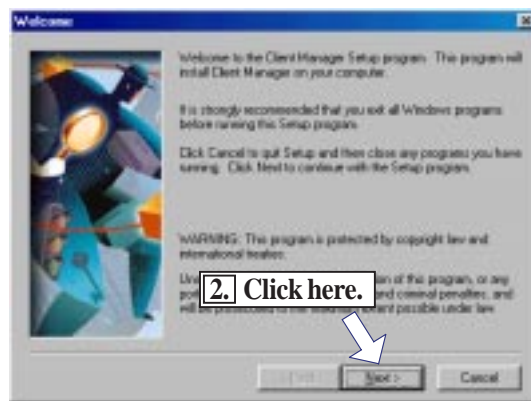
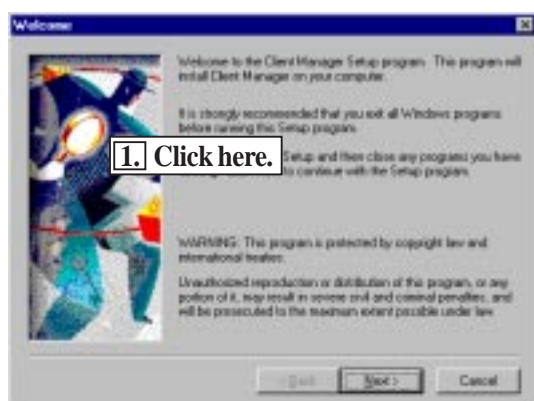

V. SOFTWARE SETUP

LDCM Local Setup (Cont'd)



7. Click here.



8. Click here.



9. Click here.



10. Click here.

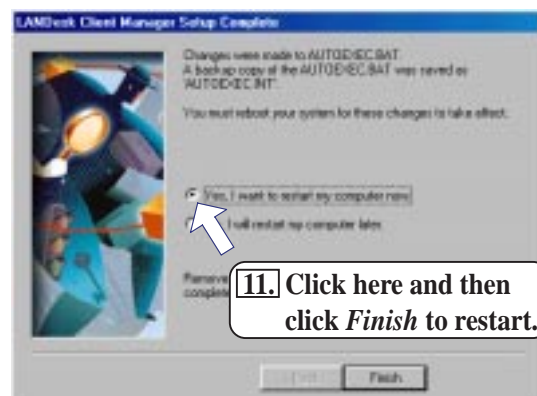

11. Click here and then click *Finish* to restart.

V. SOFTWARE SETUP

LDCM Administrator Setup

Insert the Support CD that came with your motherboard into your CD-ROM drive or double-click the CD drive icon in **My Computer** to bring up the autorun screen.

NOTE: LDCM will not run if ASUS' PC Probe utility is installed. To uninstall PC Probe, see section on *Uninstalling Programs*.

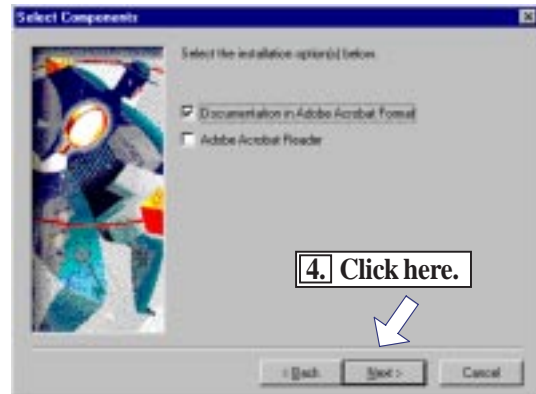
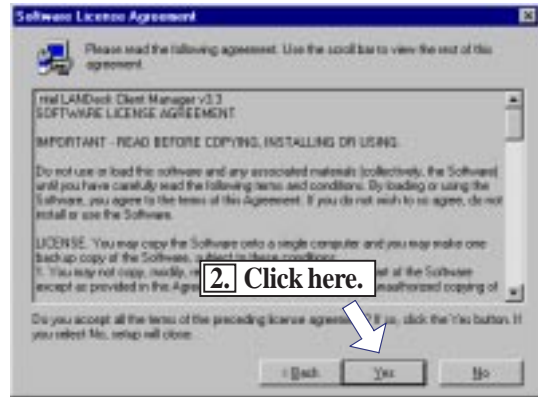
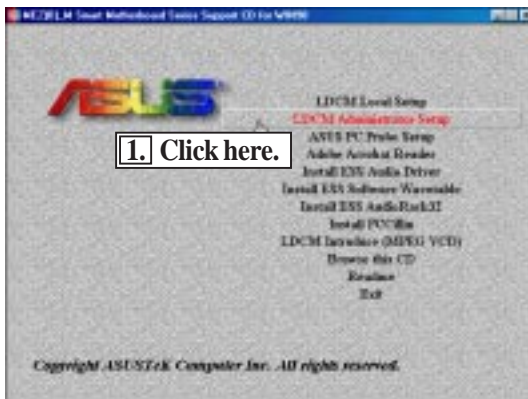

V. SOFTWARE SETUP

Uninstalling Programs

Add/Remove Programs is a basic component within Windows. You may use this function if a program does not provide its own uninstallation program.

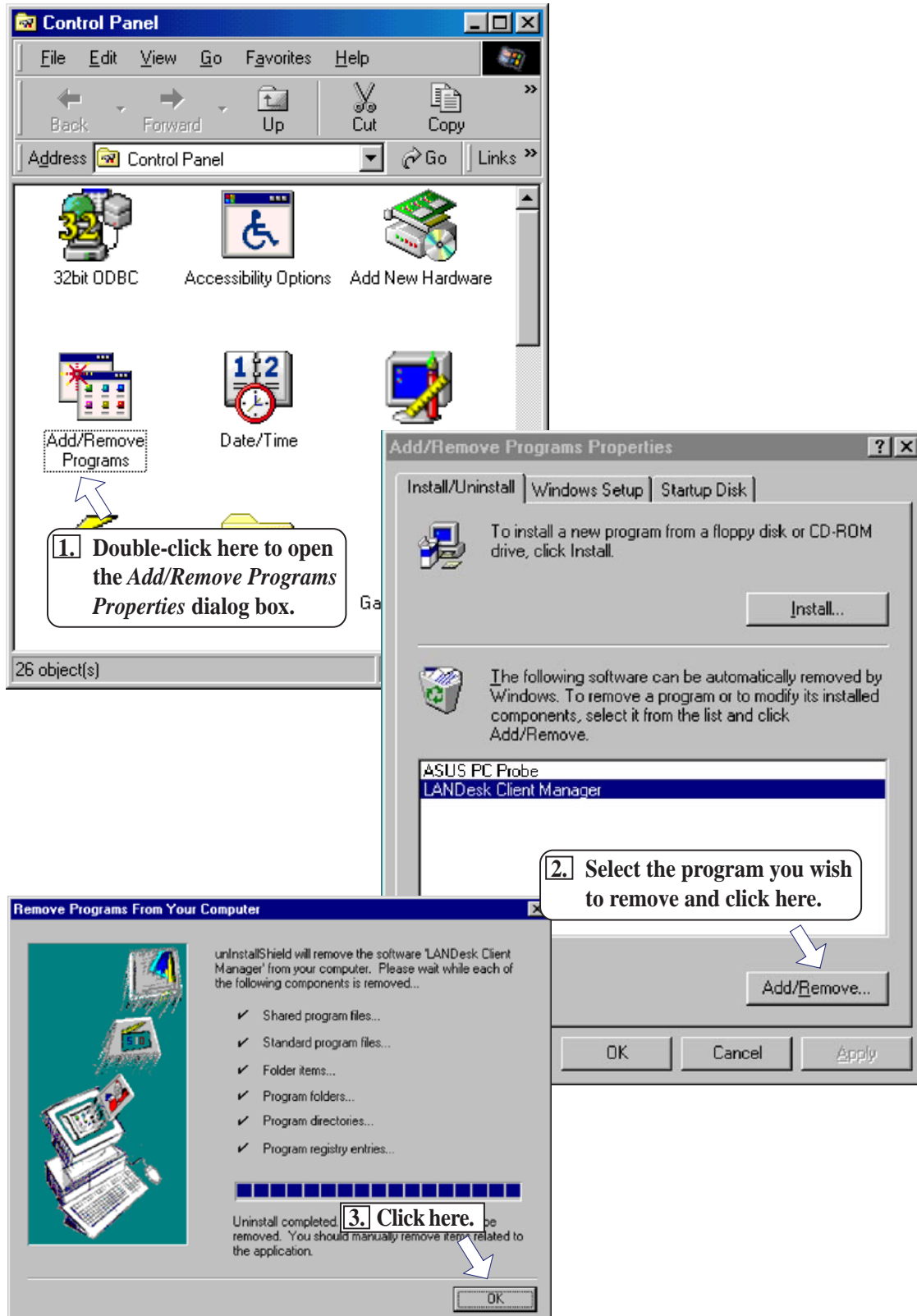

VI. SOFTWARE REFERENCE



VI. SOFTWARE REFERENCE

AudioRack32	75
The Command Center	76
The Miniature Mode	77
The Audio Mixer	78
The Digital Audio Player	79
The MIDI Player	80
The Compact Disk Player	81
The Audio Recorder	82
Release Notes	83
ASUS PC Probe	85
Starting ASUS PC Probe	85
Using the ASUS PC Probe	86
Using the ASUS PC Probe	86
Intel LANDesk Client Manager	88
Main Client Manager Window	88
Using the Taskbar icons	89
Using the Select Computer Dialog Box	90
To select a computer	91
To discover new computers	91
To refresh PC health	91
To remove a computer from the list	91
To wake up a computer	91
Displaying the Properties of a Client Computer	92
Understanding the Computer Status Icons	93
Desktop Management Interface (DMI)	94

VI. SOFTWARE REFERENCE

AudioRack32

The **AudioRack32** enables you to take advantage of your computer's audio capabilities with all of the controls conveniently in one compact space. You can play audio CDs, wave files (in WAV and .AUD formats), and MIDI files (in .MID and .RMI formats). With the multisource Audio Mixer, you can blend these sources with line-in and microphone sources any way you choose. You can then record your creations as wave files and edit them with the Audio Recorder.

The **AudioRack32** has six main parts:

- Command Center—customizes the appearance of the **AudioRack32**.
- Audio Mixer—controls the volume and balance of the **AudioRack32** devices.
- Digital Audio Player—plays and records files in the .WAV format.
- MIDI Player—enables you to play MIDI files.
- Compact Disk Player—enables you to play audio CDs on a CD-ROM drive.

In addition, the **AudioRack32** has a miniature mode enabling you to control the **AudioRack32** while using minimal screen space.

The Audio Recorder is a separate application from the **AudioRack32**. It can be used to add effects and edit files recorded with the Digital Audio Player or by the Audio Recorder itself. The Audio Recorder can be launched from the **AudioRack32**'s Digital Audio Player or on its own.



VI. SOFTWARE REFERENCE

The Command Center

The Command Center controls which parts of the *AudioRack32* are displayed. You can display or hide any part of the *AudioRack32* you choose, customizing its appearance to suit your needs or desires. It also displays information on the status of the different audio components.

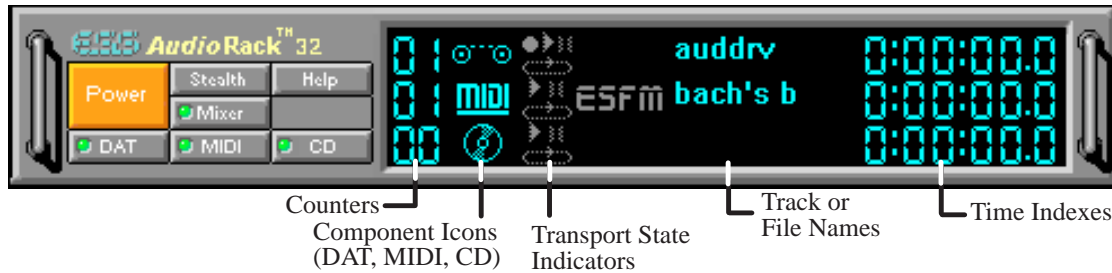

The Command Center Controls

- Power** closes the *AudioRack32* window.
- Stealth** enables the Miniature mode, minimizing the *AudioRack32* display.
- DAT** displays/hides the Digital Audio Player.
- Help** accesses On-line Help.
- CD** displays/hides the Compact Disk Player.
- Mixer** displays/hides the Audio Mixer.
- MIDI** displays/hides the MIDI Player.

The Command Center Display

Counter: shows you which track or file in the playlist the component is playing.

Component Icon: is displayed when the associated component is shown and is not displayed when the component is hidden.

Transport State Indicator: shows the state of a component. It indicates when the component is playing, paused, has the Auto Repeat enabled, or in the case of the Digital Audio Player, is recording.

Track or File Name: shows the name of the current track or file in the playlist.

Time Index: displays the amount of time elapsed for the track or file in hours, minutes, seconds, and tenths of a second.

VI. SOFTWARE REFERENCE

The Miniature Mode

The Miniature mode is designed to give you full control of the *AudioRack32* while using a minimum of space. You are able to effectively use the *AudioRack32* and still have enough room on your desktop to run other applications. In the Miniature mode, you can play, pause, stop, and control the master volume of the *AudioRack32*.

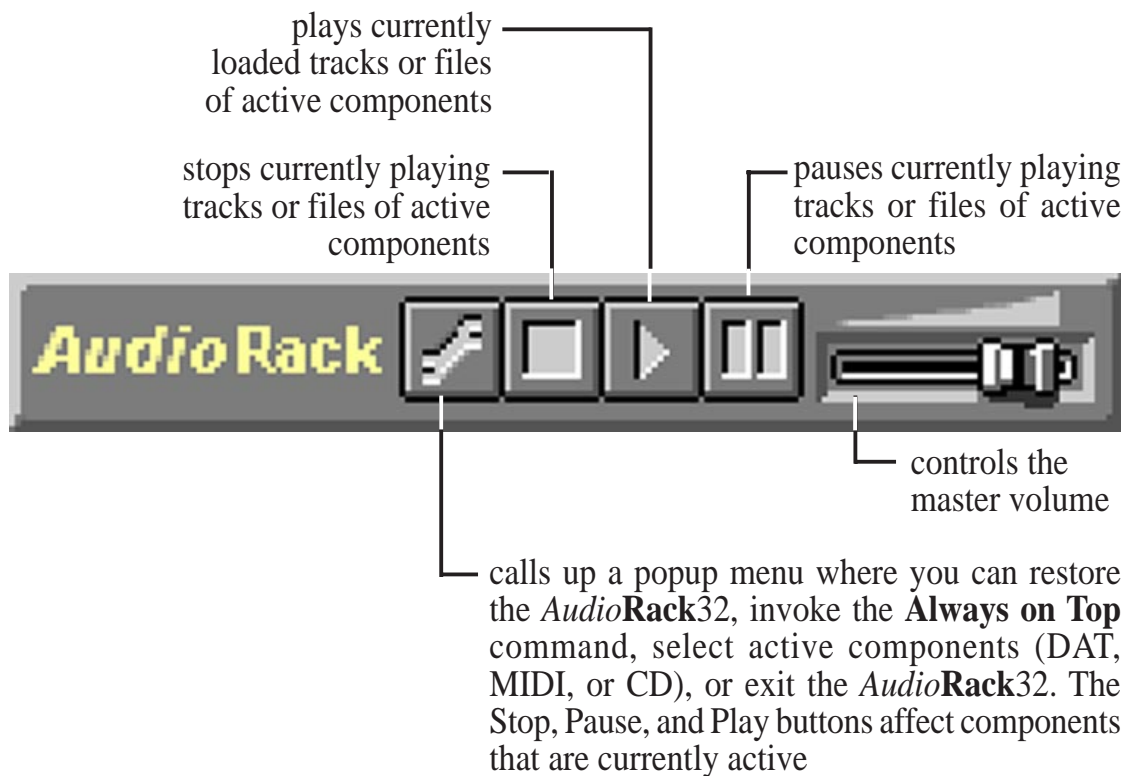

VI. SOFTWARE REFERENCE

The Audio Mixer

The Audio Mixer has two modes: Playback mode and Record mode. You can use these two modes to fully control which of your audio sources you are listening to or recording, how loud each of those sources are and how they are balanced. Each audio source has its own module with mute, balance and volume controls.

In addition, the Audio Mixer provides special effects controls for chorus, reverb, treble, bass, and 3-D effects.



The Audio Mixer Controls

The two Playback and Record toggle buttons are used to switch between Playback mode and Record mode.

The Effects toggle button switches the display to the effects panel where you can use the buttons to enable and disable effects and the sliders to control the amount of the effect.

There are a number of audio source modules displayed on the Audio Mixer. The exact number displayed depends on the capabilities of your hardware. Each module has three controls:



a slider to adjust the balance

a slider to adjust the volume

a button for muting

Modules that your hardware may provide for are: Master, Line, Wave, Mic, CD, MIDI, and Aux B.















VI. SOFTWARE REFERENCE

The Digital Audio Player

The Digital Audio Player enables you to play, record, and compress sound as .WAV files. In addition, you can play .AUD files. The .WAV files use PCM, which is the Windows' audio file format. The .AUD format uses ESPCM' compression to produce an audio file. Files are written directly to your hard disk as you record, enabling you to record very large files. Your only limitation is the amount of free space on your hard disk. The voice activation feature is useful for recording any kind of intermittent audio. The Digital Audio Player provides a choice of linear PCM (8 or 16 bit) recording. Note that you have additional options using the Audio Recorder, which is invoked by the **Edit** button.



The Digital Audio Player Controls

-  starts recording to your hard disk.
-  goes to the end of the wave file or to the next file in the current playlist.
-  plays the wave file currently loaded.
-  enables or disables the Auto Repeat.
-  activates or deactivates the Pause
-  opens the Audio Recorder window.
-  stops the file currently playing.
-  opens the Set Playlist dialog box.
-  goes back one second in the wave file.
-  starts a new file by opening the New Options dialog box.
-  goes forward one second in the wave file.
-  brings up the Open file dialog box in order to load a file into the Digital Audio Player.
-  goes to the beginning of the wave file or to the previous file in the current playlist.
-  saves an audio file.

The Digital Audio Player Display

 The Level Meter displays the output from the left (top) and right (bottom) channels when a wave file is played.

 By clicking on the image of the tape deck, you can display information about the file currently loaded in the Digital Audio Player. The display tells you the file name, size, number of bits per sample, sample rate, and whether the file was recorded in stereo or mono. Click again to return to the image of the tape deck.

audrv.wav
47 Kbytes
16 bit 22 kHz
Mono









VI. SOFTWARE REFERENCE

The MIDI Player

The MIDI Player enables you to play MIDI files with the .MID or .RMI file extensions. These MIDI (Musical Instrument Digital Interface) files can be produced by sequencer programs and then played back using the MIDI Player. You can also mix MIDI files with other audio sources. Or you can compile MIDI files in a playlist and play them back in any order you choose.



The MIDI Player Controls

-  plays the MIDI file currently loaded.
-  goes back one file in the playlist.
-  activates/deactivates Pause
-  goes forward one file in the playlist.
-  stops the file currently playing.
-  enables/disables the Auto Repeat.
-  goes back one second in the MIDI file.
-  opens the Set Playlist dialog box.
-  goes forward one second in the MIDI file.

The MIDI Player Display

By clicking on the image of the floppy drive, you can display the length and name of the current MIDI file in the playlist. Click the display to return to the image of the floppy drive.











 The MIDI Player has an indicator to show when you are listening to ESFM. When the ESFM light to the left of the playlist button is lit, the MIDI Player is using ESFM synthesis. ESFM performs superior-quality music synthesis compared to that of traditional FM, producing richer timbre and greater depth of instrument voices. **FM synthesis is a lower quality technology compared with Wave table synthesis. This card supports Wave table synthesis therefore ESFM is not supported on this card.**

VI. SOFTWARE REFERENCE

The Compact Disk Player

If you have a CD-ROM drive, you can play audio CDs. Check your hardware manual about setting up CD audio hardware and drivers. The Compact Disk Player uses intelligent CD playlist management: The Compact Disk Player maintains a record of each CD you play. It remembers the last playlist you used with each CD and loads that playlist automatically whenever you insert that CD.

The Compact Disk Player Controls

-  plays the MIDI file currently loaded.
-  goes back one file in the playlist.
-  activates or deactivates the Pause
-  goes forward one file in the playlist.
-  stops the file currently playing.
-  enables or disables the Auto Repeat.
-  goes back one second in the MIDI file.
-  opens the Set Playlist dialog box.
-  goes forward one second in the MIDI file.
-  ejects the CD from the CD-ROM drive.

VI. SOFTWARE REFERENCE













The Audio Recorder

The Audio Recorder enables you to record, compress, store, and play back voice, music, and other sound. It provides settings for sound attributes such as mono/stereo, compression level, and sampling rate. You can use it to embed sound objects in documents created in applications that support object linking and embedding (OLE).

The Audio Recorder's edit, record, and playback capabilities are compatible with the Windows Sound Recorder and other recorders that record and play back in the PCM format. Like the Digital Audio Player, the Audio Recorder can record and play back .WAV and .AUD files. The Audio Recorder allows a choice of compression from low, medium, and high ESPCM and ADPCM.



The Audio Recorder Controls

-  starts a new audio file.
-  inserts the Clipboard audio at the cursor or replaces the selected portion.
-  opens an audio file.
-  mixes the Clipboard audio with the audio beginning at the cursor.
-  saves an audio file.
-  starts recording.
-  reverses the last change you made to the current audio file.
-  plays the currently loaded audio file.
-  removes the selected portion of the audio file and stores it on the Clipboard.
-  stops the file currently playing or recording.
-  copies the selected audio portion to the Clipboard without removing it.
-  determines the cursor position on the waveform.

The Audio Recorder Display



The four text boxes under the tool bar display the length in seconds of the selected part of the currently loaded file, the total length in seconds of the current file, whether the file is in stereo or mono, and the sampling rate in kilohertz.

To the right of the text boxes is a box displaying the icon associated with the particular file. If a file has no icon associated with it, it is given a default icon.

VI. SOFTWARE REFERENCE

Release Notes

This information is provided for convenience only. Information here is subject to change without prior notice. View the installation CD for any updated information in Readme text files. The AudioRack also provides detailed online help (click the **Help** button on the “Command Center”)

Disable Eject Button on the CD Player

Under the Windows directory in the file “auddrive.ini”, there is a string “DisableEjectButton=0” under the [cdplayer] section. If you would like to disable EJECT button on the CD player, you can change the value from 0 to 1. You need to close AudioRack and launch it again to make the new settings take effect.

Using AudioRack CD Player as Default CD Player

During installation, you will be asked if you want to use AudioRack CD player as the default CD player. Normally Windows 95 CD player is the default and will automatically run when an audio CD is inserted into the CD-ROM. If you answer “Yes”, the installation program will overwrite the value of the key [HKEY_CLASSES_ROOT]\AudioCD\shell\play\command in the registry. You may switch back to Windows 95 CD player by resetting this key value.

Configuring Playback Mixer

The Maestro PCI audio card offers eight inputs for the playback mixer, including “Line”, “Wave”, “CD”, “Synth”, “Aux A”, “Aux B”, “Mic”, and “Mono In”. AudioRack can only display six of them at a time. You may configure the settings by modifying the file “auddrive.ini” in the Windows directory. Under the section [MixerRak], you can enable or disable the display of each input by setting its corresponding binary value to 1(enable) or 0(disable).

VI. SOFTWARE REFERENCE

(This page was intentionally left blank)

VI. SOFTWARE REFERENCE

ASUS PC Probe

ASUS PC Probe is a convenient utility to monitor the computer system's vital components: fan rotations, voltages, and temperatures.

Starting ASUS PC Probe

When ASUS PC Probe starts, a splash screen appears allowing you to “Show Monitor” or “Hide”. You can select whether you want the splash screen to show the next time it opens.



Click **ASUS PC Probe** from the **Start** button to run the utility if you exit the utility or did not set it to “Run when Windows Starts.”

The PC Probe icon  will appear on the taskbar's system tray indicating that ASUS PC Probe is running. Left-clicking the icon will allow you to see your PC status.



VI. SOFTWARE REFERENCE

Using the ASUS PC Probe

Fan Rotation Status

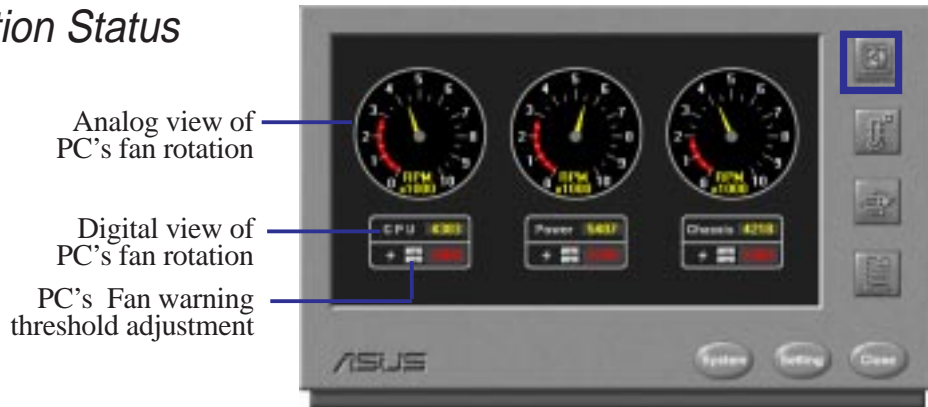

PC Temperature Status

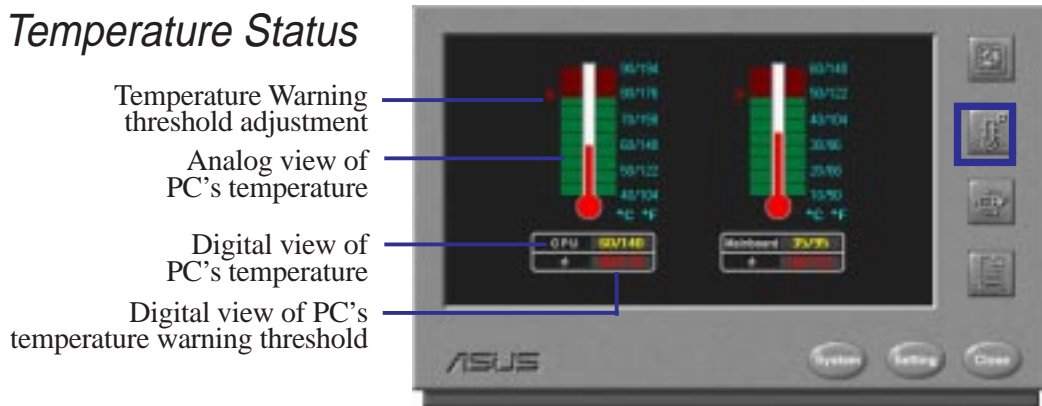

PC Voltage Status

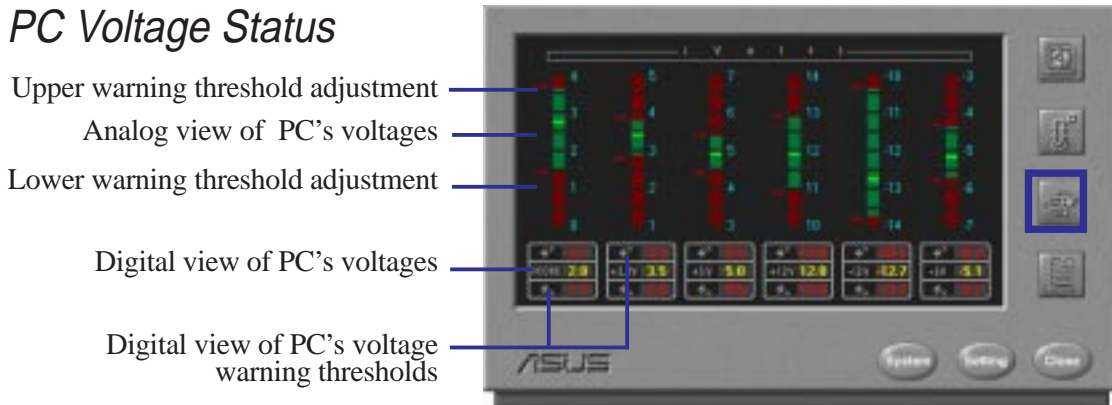

PC Status Summary

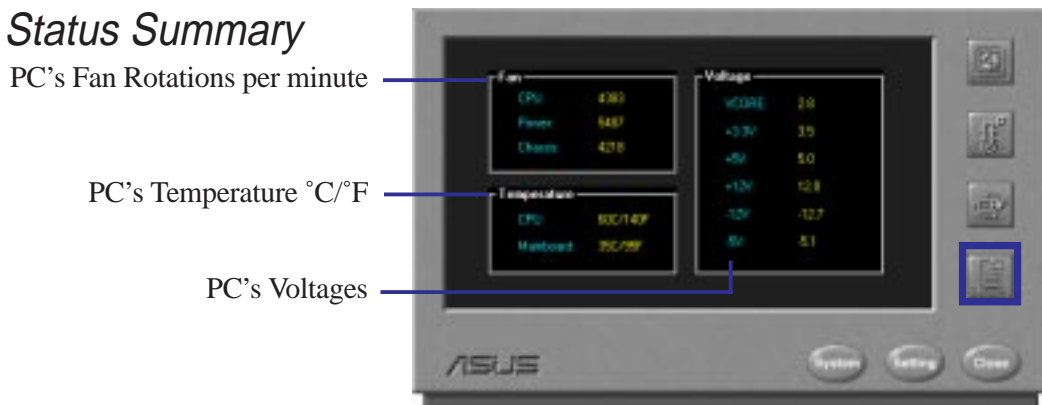

VI. SOFTWARE REFERENCE

Using the ASUS PC Probe

PC Probe System Info.



Get information on your mainboard and BIOS from this screen.

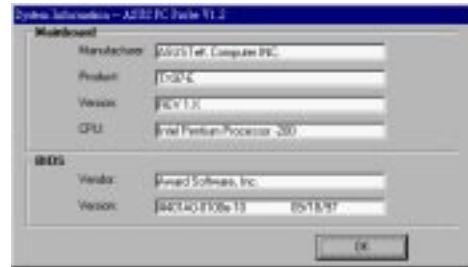

PC Probe Settings



Change PC Probe refresh times here

Click here to start PC Probe each time you enter Windows.



Click the items you wish to reset to its default values and click this button.

PC Probe Task Bar Icon

Right clicking the PC Probe icon will bring up a menu to turn on, off, or exit ASUS PC Probe.



The icon appears dimmed when off or unavailable.



When there is a problem, the icon's head mirror flashes red, the PC speaker beeps, and the ASUS PC Probe monitor is displayed.

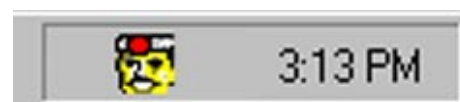

VI. SOFTWARE REFERENCE

Intel LANDesk Client Manager

With the growth of the computer industry, computer systems have become more complex and difficult to manage. Intel LANDesk Client Manager is a computer management application that simplifies many aspects of managing a computer and assists in troubleshooting common computer problems.

Use Client Manager to:

- Review system inventory
- View DMI-compliant component information
- Backup and restore system files
- Troubleshoot
- Monitor your computer's health
- Receive notifications for system events

Client Manager has been implemented in two different ways:

The client version enables you to view information and manage alerts for a local computer. This version does not permit you to select remote computers, transfer files, or reboot other computers.

The first time you run Client Manager, it searches your network for other computers running Client Manager. Client Manager creates a list of the computers it finds and saves the list to the Windows registry. From this point on, when you run Client Manager or open the Select Computer dialog box, Client Manager checks to see if these computers (listed in the registry) are available and healthy.



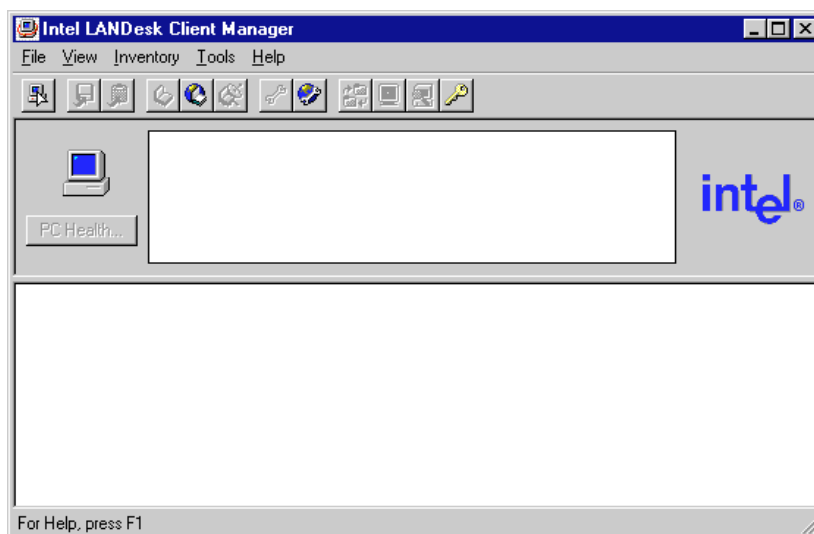







Main Client Manager Window



VI. SOFTWARE REFERENCE

Using the Taskbar icons

Toolbar Descriptions

	Opens the Select Computer dialog box	File Select Computer
	Opens the Export dialog box to export the inventory to a file	File Export
	Exports the inventory to the clipboard	File Export to clipboard
	Opens the notification log	View Notification Log
	Opens the global notification log	View Global Notification Log
	Opens the remote access log	View Remote Access Log
	Opens the Configure Notifications dialog box	Tools Configure Notifications
	Opens the Configure Global Notifications dialog box	Tools Configure Global
	Opens the File Transfer dialog box	Tools Transfer Files
	Reboots the computer	Tools Reboot
	Opens the DMI Explorer	Tools DMI Explorer
	Opens the Set Access Rights dialog box	Tools Set Access Rights

VI. SOFTWARE REFERENCE

Using the Select Computer Dialog Box

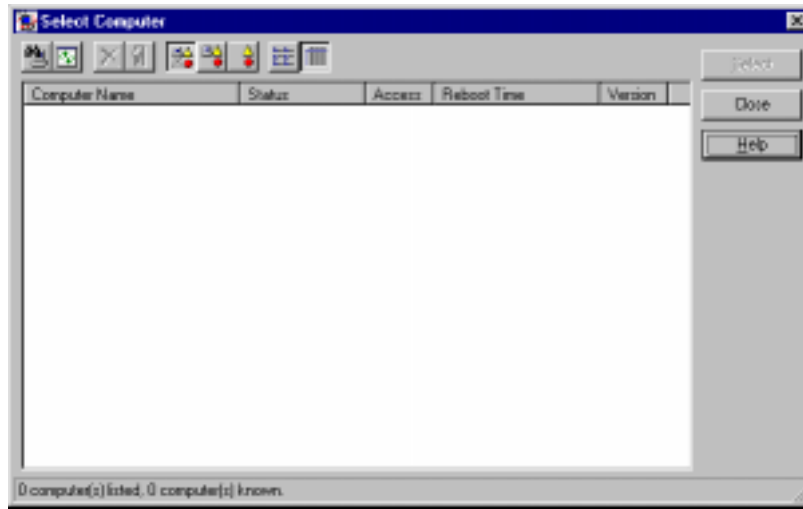

Discovers new computers on the network



Refreshes the health of known computers



Removes a computer from the list of discovered computers



Wakes up a sleeping computer



Shows all discovered computers



Shows only available computers



Shows only unhealthy computers



Shows a simple list view



Shows a detailed list view

VI. SOFTWARE REFERENCE

To select a computer

1. From the main Client Manager window, click **File | Select Computer**.
2. In the *Select Computer* dialog box, click the computer you want to view.
3. Click the **Select** button.

To discover new computers

- In the *Select Computer* dialog box, click the **Discover** button on the toolbar or press <Shift>+<F5>.

TIP: Use the **Discover** button each time you add a computer to the network, change a computer's network adapter, or upgrade a computer to a newer version Client Manager.

To refresh PC health

- In the *Select Computer* dialog box, click the **Refresh Known Computers** button on the toolbar or press <F5>.

TIP: PC health does not automatically update as changes occur. For example, if a computer's health changes while you are displaying the *Select Computer* dialog box, you need to refresh the list in order to view the correct PC health.

To remove a computer from the list

1. In the *Select Computer* dialog box, click the computer name you want to remove.
2. Click the **Remove Computer** button on the toolbar or press Delete.
3. At the prompt, click the **Yes** button.

TIP: Perform this task each time you remove a computer from the network, since the name of that computer is not automatically removed from this list.

To wake up a computer

1. In the *Select Computer* dialog box, click the computer name you want to wake up. You can also <Shift>+click to select a continuous group of computers or <Ctrl>+click to select individual computers in the list.

TIP: You can only attempt to wake up computers that have a status of Unavailable or Wakeable. If the *Select Computer* dialog box does not display any computers with a status of Unavailable or Wakeable and you suspect it should, the list view may be filtered to display only unhealthy or available computers. You may need to change your list view to display all computers.

2. Click the **Wake Up Computer** button on the toolbar to wake up the selected computer(s) or press <Alt>+<W>.

VI. SOFTWARE REFERENCE

After you attempt to wake up a computer, the status of that computer changes in the list view to a Wake Pending status. If the attempt to wake up a computer is successful, the Wake Pending status changes to a status reflecting the computer's health (such as Normal, Warning, or Critical). If the computer does not wake up after five minutes, a message box appears stating possible reasons why the computer did not respond. (For example, the computer may be disabled or may not support Wake-On-LAN.) After clicking OK, the Wake Pending status reverts to its original status of Unavailable or Wakeable.

NOTE: Your computer must have a Wake-On-LAN network adapter to support this feature. Some computers that support the Wake-On-LAN technology may have remote wakeup disabled in the BIOS by default. Before Client Manager can wake up a remote computer, you will need to enable this option in the BIOS configuration of each remote computer.









Displaying the Properties of a Client Computer

You can display the properties of any discovered client computer even if you cannot otherwise access the computer because of access limitations or Unavailable status. If you display the properties of an unavailable computer, the properties are read from a database in the Windows registry on your computer. Since the Operating System information is not stored in this same database, that information is not available for a computer with a status of Unavailable. Remember that some items may not be current if the properties have changed while the computer was off the network.

VI. SOFTWARE REFERENCE

Understanding the Computer Status Icons

When you open the Select Computer dialog box, each computer in the list displays an icon indicating the current status of that computer. The table below describes the seven states a computer may be in.

	Unavailable	The computer is currently in a powered-down state.
	Wakeable	The computer is currently in a powered-down state but supports Remote Wakeup technology.
	Wake Pending	A temporary status (not to exceed five minutes) while Client Manager attempts to wake up a computer. (A computer that is in the process of booting without having received a wakeup instruction is listed as <i>Unavailable</i> , not <i>Wake Pending</i> .)
	Normal	The computer is operating within normal tolerances.
	Warning	A computer that has exceeded a warning tolerance level. For example, the PC Health indicator can be configured to display a warning icon if a hard disk is running low on space.
	Critical	A computer that has exceeded a critical tolerance level. For example, if the hard disk is running critically low on available space, the PC Health indicator displays a critical icon.
	Unknown	A computer that is powered on, but the health status (Normal, Warning, or Critical) is not known.
	Normal (Mobile)	A computer that includes support for mobile PC features, such as mobile battery. Mobile computers display the same array of health icons (above) used for non-mobile computers.

VI. SOFTWARE REFERENCE

Desktop Management Interface (DMI)

Introducing the ASUS DMI Configuration Utility

This motherboard supports DMI within the BIOS level and provides a DMI Configuration Utility to maintain the Management Information Format Database (MIFD). DMI is able to auto-detect and record information pertinent to a computer's system such as the CPU type, CPU speed, and internal/external frequencies, and memory size. The onboard BIOS will detect as many system information as possible and store those collected information in a 4KB block in the motherboard's Flash EPROM and allow the DMI to retrieve data from this database. Unlike other BIOS software, the BIOS on this motherboard uses the same technology implemented for Plug and Play to allow dynamic real-time updating of DMI information versus creating a new BIOS image file and requiring the user to update the whole BIOS. This DMI Configuration Utility also allows the system integrator or end user to add additional information into the MIFD such as serial numbers, housing configurations, and vendor information. Those information not detected by the motherboard BIOS and has to be manually entered through the DMI Configuration Utility and updated into the MIFD. This DMI Configuration Utility provides the same reliability as PnP updating and will prevent the refreshing failures associated with updating the entire BIOS.

Starting the ASUS DMI Configuration Utility

The DMI Configuration Utility (DMICFG2.EXE) must be used in real mode in order for the program to run, the base memory must be at least 180K. Memory managers like HIMEM.SYS (required by windows) must not be installed. You can boot up from a system diskette without AUTOEXEC.BAT and CONFIG.SYS files, "REM" HIMEM.SYS in the CONFIG.SYS, or press <Shift>+<F5> during bootup to bypass your AUTOEXEC.BAT and CONFIG.SYS files.

1. In Windows, copy DMICFG.EXE to your hard disk drive.
2. Restart your computer and press <Shift>+<F5> during bootup to enter safe mode command prompt.
3. Go to the directory containing DMICFG.EXE.
4. Type DMICFG and press <Enter> to run.

VI. SOFTWARE REFERENCE

Using the ASUS DMI Configuration Utility

NOTE: The following screen displays are provided as examples only and may not reflect the screen contents on your system.

Edit DMI (or delete)



Use the ←→ (left-right) cursors to move the top menu items and the ↑↓ (up-down) cursor to move between the left hand menu items. The bottom of the screen will show the available keys for each screen. Press enter at the menu item to enter the right hand screen for editing. “Edit component” appears on top. The reversed color field is the current cursor position and the blue text are available for editing. The orange text shows auto-detected information and are not available for editing. The blue text “Press [ENTER] for detail” contains a second pop-up menu is available, use the + - (plus-minus) keys to change the settings. Enter to exit *and save*, ESC to exit *and not save*.

If the user has made changes, ESC will prompt you to answer Y or N. Enter Y to go back to the left-hand screen *and save*, enter N to go back to left-hand screen and *not save*. If editing has not been made, ESC will send you back to the left hand menu without any messages.

Notes

A heading, *** BIOS Auto Detect ***, appears on the right for each menu item on the left side that has been auto detected by the system BIOS.

A heading, *** User Modified ***, will appear on the right for menu items that have been modified by the user.



VI. SOFTWARE REFERENCE

Save MIFD



You can save the MIFD (normally only saved to flash ROM) to a file by entering the drive and path here. If you want to cancel save, you may press ESC and a message “Bad File Name” appears here to show it was not saved.

Load MIFD



You can load the disk file to memory by entering a drive and path and file name here.

Load BIOS Defaults



You can load the BIOS defaults from a MIFD file and can clear all user modified and added data. You must reboot your computer in order for the defaults to be saved back into the Flash BIOS.